

# Spectrum

Lamp catalogue 2008/2009



# GE Lighting

GE Lighting – a division of GE Consumer & Industrial – is one of the largest suppliers of light sources in the world, providing state-of-the-art technology, ranging from incandescent to speciality products. Providing solutions for commercial, industrial and residential use in more than 100 countries, GE Consumer & Industrial uses innovative technologies and "ecomagination," a GE initiative to aggressively bring to market new technologies that help customers and consumers meet pressing environmental challenges, to deliver comfort, convenience and electrical protection and control. General Electric (NYSE: GE) brings imagination to work, selling products under the Enrich™, Biax™, ConstantColor™, Lucalox™, Starcoat™, LongLast™ and Watt-Miser™ brands.

GE Lighting is constantly developing and improving its products. For this reason, all product descriptions in this brochure are intended as a general guide, and we may change some specifications from time to time in the interests of product improvement.

#### **General conditions of sale**

GE Lighting products are supplied according to the Company's General Conditions of Sale.

If you require a copy of these conditions please contact your nearest GE Lighting sales office.

#### **Prices**

A price list is available from all GE Lighting sales offices.

## ecomagination<sup>SM</sup>

The future can seem pretty intimidating: Our known reserves of oil and natural gas are expected to be depleted by 2045, the climate is changing, and more than a billion people lack clean water. At GE, we believe some of the world's most pressing challenges present an opportunity to do what we do best: **imagine and build innovative solutions that benefit our customers and society at large.**

As a global leader in energy, technology, manufacturing, and infrastructure, GE is uniquely suited to help solve environmental challenges, today and for generations to come. Our customers want a more prosperous, cleaner future. By harnessing our most abundant renewable resource - the imagination of our people - we can create that future with them. We are taking a new approach to solving some of our customers' toughest environmental problems.

**We call it ecomagination.**

### **Our Heritage, Our Future**

We believe that better technology is the answer to our customers' environmental challenges. And we are confident we can find tomorrow's solutions to those challenges just as we have since the days of our founder, Thomas Edison. Throughout our 128-year history, we have invented solutions to meet our customers' greatest needs. Over many years, we have developed one of the broadest ranges of environmentally advanced technologies. We will build on this legacy of success by researching and developing next-generation clean technologies. Our goal is to be a leader in bringing clean energy, air, and water and improved quality of life to all the world's citizens.



## Introduction

This is GE... It begins with the best ideas in class and leads to quality products with proven demand, for which GE can offer long term services. We build client relationships with our customers to spark off ideas for new innovations.

### imagination at work











GE has always been a company that stands for progress. For more than 100 years we have been able to tell stories about GE innovations. GE's new imagination at work approach is about GE people, their curiosity, relentless drive, hard work and willingness to take risks – combined with a foundation of limitless imagination – that makes anything possible. It's a legacy of progress that began with our founder, Thomas Edison, and one that will continue through the 21st century. At GE, what we imagine, we can make happen.



As a Worldwide Partner of the Olympic Games, GE is the exclusive provider of a wide range of innovative products and services that are integral to the successful Games.



# Contents

<b>Incandescent Lamps</b>	<hr style="border: 1px solid red;"/>	8	
<b>Halogen Lamps</b>	<hr style="border: 1px solid orange;"/>	28	
<b>Fluorescent Lamps</b>	<hr style="border: 1px solid yellow;"/>	52	
<b>Compact Fluorescent Lamps</b>	<hr style="border: 1px solid green;"/>	74	
<b>High Intensity Discharge Lamps</b>	<hr style="border: 1px solid blue;"/>	100	
<b>SHOWBIZ® Lamps</b>	<hr style="border: 1px solid purple;"/>	122	
<b>Speciality Lamps</b>	<hr style="border: 1px solid darkpurple;"/>	148	
<b>LED Lamps</b>	<hr style="border: 1px solid gray;"/>	156	
<b>Glossary</b>	<hr style="border: 1px solid lightblue;"/>	158	
<b>Sales Offices</b>	<hr style="border: 1px solid black;"/>	164	
<b>Product Index</b>	<hr style="border: 1px solid black;"/>	166	

## Introduction

# Improved colour

Quality of light is a key benefit of GE lamps. Objects and colours appear more vivid and lively thanks to the extraordinary colour rendering feature of GE lamps.

**CMH SuperMini** – “halogen-like” light that provides dramatic accents and highlights with excellent colour rendering. Lamp to lamp colour conformity and consistent colour over life.



**Halogen G9 Capsule** – launched under the “TECH” brand as a sign of its high quality and performance – gives out a brighter, whiter light providing a high 2800K colour temperature. The new Capsule offers a constant light quality throughout its whole life.



**AR111 Bright and white Halogen** – excellent quality of light (up to 2950K) for decorative and architectural lighting.



**MR16 Mains** – This compact mains voltage halogen lamp gives out excellent white light up to 2800K. With the aluminium coating this reflector lamp directs most of its heat to the front.



**T5 Starcoat™ lamp** – Starcoat™ is a proprietary coating technology that eliminates the need for traditional lower quality halophosphor coating by reflecting the UV-light more effectively. This leaves a pure triphosphor coating for excellent colour rendering and lumen maintenance performance.



**Precise™ ConstantColor™ MR16** – features revolutionary GE Thin Film Coating Technology to ensure consistent colour throughout life.

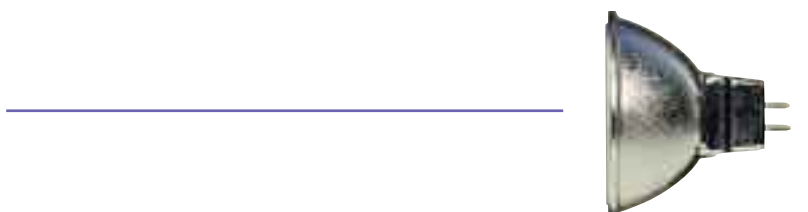

## Reduced energy

Reduce your energy consumption whilst providing improved quality of light, lamp life, colour rendering and energy efficiency.

**Genura™ lamps** – save up to 80% on energy compared to standard incandescents. At 23W, Genura provides up to 80% energy savings compared to 100W R80 reflector lamps.



**Biax™ Extra Mini Electronic Lamps** – GE's Extra Mini uses around 20% of the electricity, versus ordinary light bulbs. Saving energy means saving money. And you're not sacrificing light for lower watts.



**Biax™ Plug-in Replaceable lamps** – Through outstanding energy efficiency, a significant percentage of your annual electricity bill can be saved.



### **T5 & T8 Watt-Miser™**

GE's new Watt-Miser™ fluorescent range will save money on your lighting costs. They use less energy than similar products on the market and help reduce your organisation's carbon footprint.



### **Lucalox™ XO**

This type of High Pressure Sodium lamp provides 20% more light compared to standard Lucalox lamps.



## Introduction

# Longer life

Longer life means fewer burned out lamps to replace, reducing labour and maintenance costs.

**Precise™ ConstantColor™ MR16** – ensures outstanding long life up to 6000 hours.



**Biax™ Extra Mini** – GE's Extra Mini lamps last about 15 times as long as an ordinary light bulb. Longer life means fewer burned out lamps to replace and reduce labour and maintenance costs.



**Lucalox™ Superlife HPS lamp** – 67% longer life than standard HPS-up to 55,000 hours. With continuous light after power interruption – standby feature.



**CFL Biax Plug-in LongLast™ range** – GE's enhanced line of plug-in products includes technical improvements to Biax™ lamps, where the lamp life has been increased by 66% to 20,000 hours



**T5 Starcoat™ Linear Fluorescent HO & HE System** – Efficiency and elegance couples in this type. Achieves 30,000 hours with electronic ballast, making this lamp type extremely efficient in commercial and retail application in both direct and indirect luminaires.



## System solution

GE Lamps and Ballasts are the perfect combination for superior light output and long life. Energy savings, superior performance and light quality, are benefits of GE's electronic ballast and lamp systems, which enables the creation of a new, environmentally friendly solution for both luminaire manufacturers and lighting designers.

### CMH Electronic Ballasts – Coupling

ConstantColor™ CMH lamps with dedicated GE electronic ballasts will ensure further enhanced performance throughout a long lamp life. All CMH ballasts offered by GE are electronic, giving important advantages over conventional electromagnetic circuits.



### CFL Electronic Ballasts – Multiwatt

electronic ballast operates best with GE's high output compact fluorescent lamps: the Biax™ Q/E 57W and 70W. A single ballast is suitable for both lamp wattages, enabling more flexibility in design and manufacturing.



### LFL Electronic Ballasts – GE's energy efficient

electronic T5 and T8 ballasts are ideally suited to operate with fluorescent lamps. The multiwatt design reduces the number of ballast types needed, enabling more flexibility in luminaire design and manufacturing. The recently launched Ultrastart™ ballasts are the new generation of T5 Programmed Start ballasts that addresses the growing demand for energy-saving strategies incorporating occupancy sensors and other automated light controls.



GE incandescent lamps trace their ancestry to the world's first practical electric bulb, invented by Thomas Alva Edison, founder of General Electric Company, in 1879.

More than a century of research and development later, our current range of GE incandescent lamps represent state-of-the-art lamps for residential and commercial use, as well as special purpose lamps for decorative and display applications. Today's incandescent bulb houses a tungsten filament. When charged with electric current, the filament becomes white hot, and glows through a process called incandescence. Incandescent lighting is the most prevalent form of lighting today due to its flexibility and cost. Incandescent lamps are commonly available in a large variety of size, shape, colour and wattage offering a wide range of application opportunities from home lighting to medical and industrial uses.



## Content

Standard	12
Standard Softlight elegance	13
Daylight	13
Longlife General Lighting Service	13
Extra Longlife General Lighting Service	13
Enrich™	14
Linestra	14
Krypton	14
Computer Light	14
Weekend / Insect	14
Decorative Round	16
Crown Mirrored	16
T45 Softlight elegance	17
Candle	17
Candle Softlight elegance	17
Decor Candle	18
Softlight Globe	18
Colored General Lighting Service	19
Colored Decorative Rounded	20
Colored Candle	20
Colored Pygmy	20
Reflector	22
PAR 38 Reflector Watt-Miser™	22
Enrich Reflector	22
Long Life Reflector	22
Infrared Reflector	23
Coloured Reflector	23
Pygmy	25
Fridge	25
Oven	25
Tubular T25	25
Tubular T28	25
Rough Service	27
Traffic Lights	27
Low & Extra Low Voltage GLS	27



# Incandescent lamps

## Product identification

The following glossary of terms and descriptions can help you when checking incandescent lamp specifications and explains how to use the product codes when ordering products. Within each product line, lamps are divided into families – within families lamps are listed by wattage.

**Watts:**

Energy used. To find actual energy used (kWh) multiply power (watts shown) x hours of use divided by 1000

**Product description:**

Abbreviation of the lamps' main characteristics

**Product Code:**

It is important to use this code when ordering to ensure that you receive the exact product you require

**Diameter:**

Bulb diameter in mm

**Lumens:**

The lamp's rate output after the initial 2 hours of operation

**Energy Efficiency Class:**

Energy saving code

### Standard Lamps

Watts	Volts	Cap	Diameter mm	Product Description	Lumens	Life (h)	Pack Qty	EEC	Product Code
frosted									
15	230	E27	60	15A1/FR/E27	90	1000	1/10/50	F	91178
25	230	E27	60	25A1/FR/E27	230	1000	1/10/50	E	91181
40	230	E27	60	40A1/FR/E27	415	1000	1/10/50	E	91174
60	230	E27	60	60A1/FR/E27	710	1000	1/10/50	E	91175

The finish of the lamp

**Cap/Socket**

Types for different fittings

**Volts:**

Each lamp's voltage is listed

**Pack structure:**

within one outer case 10 individual boxes shrink-wrapped. Altogether 50 lamps fit in a box.

**15 A1 / FR / E27**

Identifies the lamp's wattage

Identifies the cap type

Describes type of lamp

Identifies the finish of the lamp



# Incandescent lamps

General home,  
office & industrial lamps



Enrich™ Standard

General Lighting Service (GLS) incandescent lamps continue to be popular light sources for many applications. They are recommended for their simple operation and ease of installation.

- Standard Lamps
- Softlight Elegance Lamps
- Daylight Lamps
- Longlife GLS Lamps
- GLS Extra Longlife Lamps
- Enrich Lamps
- Linestra Lamps
- Krypton Lamps
- Computer Lights
- Weekend/Insect Lights



## Enrich™

For rich, white light that brings out the warmth of all that it touches, look to Enrich™. This unique blue glass bulb brings out the vibrant colours in furnishings and decorations by heightening colour contrast. The result is clear, crisp lighting that enhances bedrooms, living rooms, bathrooms and all the other living and entertaining areas of the home. You've worked hard to create the perfect look for your home make it even better with Enrich™.

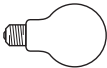

# Incandescent lamps

## Standard Lamps – Multi purpose for all applications

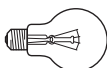
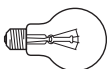
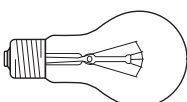
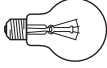
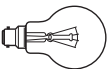
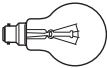
	Watts	Volts	Cap	Diameter mm	Product Description	Lumens	Life (h)	Pack Qty	EEC	Product Code
	frosted									
	60	120/125	E27	60	60A1/F/E27	820	1000	1/10/100	D	115952
	100	120/125	E27	60	100A1/F/E27	1560	1000	1/10/100	D	119382
	15	230	E27	50	15A1/FR/E27	90	1000	1/10/60	F	23552
	25	230	E27	50	25A1/FR/E27	230	1000	1/10/60	E	21670
	40	230	E27	50	40A1/FR/E27	415	1000	1/10/60	E	21671
	60	230	E27	50	60A1/FR/E27	710	1000	1/10/60	E	21673
	75	230	E27	50	75A1/FR/E27	940	1000	1/10/60	E	21675
	100	230	E27	50	100A1/FR/E27	1340	1000	1/10/60	E	21677
	150	230	E27	65	150A1/FR/E27	2160	1000	1/20	E	22568
	200	230	E27	80	200A1/FR/E27	3040	1000	1/20	E	91128
	25	240	E27	50	25A1/FR/E27	225	1000	1/10/120	E	19950
	40	240	E27	50	40A1/FR/E27	410	1000	1/10/120	E	19952
	60	240	E27	50	60A1/FR/E27	700	1000	1/10/120	E	19954
	75	240	E27	50	75A1/FR/E27	930	1000	1/10/120	E	19955
	100	240	E27	50	100A1/FR/E27	1330	1000	1/10/120	E	19956
	25	230	B22	50	25A1/FR/B22	230	1000	1/10/60	E	21657
	40	230	B22	50	40A1/FR/B22	415	1000	1/10/60	E	21658
	60	230	B22	50	60A1/FR/B22	710	1000	1/10/60	E	21663
	75	230	B22	50	75A1/FR/B22	940	1000	1/10/60	E	21664
	100	230	B22	50	100A1/FR/B22	1340	1000	1/10/60	E	21665
	clear									
	40	120/125	E27	60	40A1/CL/E27	490	1000	1/10/100	D	109410
	60	120/125	E27	60	60A1/CL/E27	820	1000	1/10/100	D	115182
	75	120/125	E27	60	75A1/CL/E27	1070	1000	1/10/100	D	117490
	100	120/125	E27	60	100A1/CL/E27	1560	1000	1/10/100	D	118780
	15	230	E27	50	15A1/CL/E27	90	1000	1/10/50	F	23546
	25	230	E27	50	25A1/CL/E27	230	1000	1/10/50	E	23547
	40	230	E27	50	40A1/CL/E27	415	1000	1/10/50	E	21666
	60	230	E27	50	60A1/CL/E27	710	1000	1/10/50	E	21667
	75	230	E27	50	75A1/CL/E27	940	1000	1/10/50	E	21668
	100	230	E27	50	100A1/CL/E27	1340	1000	1/10/50	E	21669
	150	230	E27	65	150A1/CL/E27	2160	1000	1/20	E	22566
	200	230	E27	80	200A1/CL/E27	3040	1000	1/20	E	91127
	300	230/240	E27	90	300A1/CL/E27	4850	1000	1/20	E	91226
	300	230/240	E40	90	300A1/CL/E40	4850	1000	1/20	E	91724
	40	240	E27	50	40A1/CL/E27	410	1000	1/10/120	E	19946
	60	240	E27	50	60A1/CL/E27	700	1000	1/10/120	E	19947
	75	240	E27	50	75A1/CL/E27	930	1000	1/10/120	E	19948
	100	240	E27	50	100A1/CL/E27	1330	1000	1/10/120	E	19949
	25	230	B22	50	25A1/CL/B22	230	1000	1/10/60	E	21614
	40	230	B22	50	40A1/CL/B22	415	1000	1/10/60	E	21619
	60	230	B22	50	60A1/CL/B22	710	1000	1/10/60	E	21629
	75	230	B22	50	75A1/CL/B22	940	1000	1/10/60	E	21633
	100	230	B22	50	100A1/CL/B22	1340	1000	1/10/60	E	21634
	60	250	B22	60	60A1/CL/B22	695	1000	1/10/100	E	18115
	75	250	B22	60	75A1/CL/B22	920	1000	1/10/100	E	18116
	100	250	B22	60	100A1/CL/B22	1320	1000	1/10/100	E	18117



## SOFTLIGHT ELEGANCE – Low glare in white and soft colors

Watts	Volts	Cap	Diameter mm	Product Description	Lumens	Life (h)	Pack Qty	EEC	Product Code
opal									
25	230	E27	60	25A1/SL/E27	200	1000	1/10/50	F	90540
40	230	E27	60	40A1/SL/E27	360	1000	1/10/50	F	90541
60	230	E27	60	60A1/SL/E27	620	1000	1/10/50	F	90542
75	230	E27	60	75A1/SL/E27	820	1000	1/10/50	F	90543
100	230	E27	60	100A1/SL/E27	1165	1000	1/10/50	F	90544
60	230	B22	60	60A1/SL/B22	620	1000	1/10/50	F	92038
100	230	B22	60	100A1/SL/B22	1165	1000	1/10/50	F	91546
jade*									
60	230	E27	60	60A1/JADE/SL/E27	550	1000	2/20	F	92453

\*available only in blister



## DAYLIGHT – Where crisp colors matter at work and hobby

Watts	Volts	Cap	Diameter mm	Product Description	Lumens	Life (h)	Pack Qty	EEC	Product Code
100	240	B22	60	100A1/DAYLIGHT/B22	500	1000	1/10/50	G	34950
60	240	B22	60	60A1/DAYLIGHT/B22	300	1000	1/10/50	G	35090
60	230	E27	60	60A1/DAYLIGHT/E27	300	1000	1/10/50	G	91231
100	230	E27	60	100A1/DAYLIGHT/E27	500	1000	1/10/50	G	91233
60	240	E27	60	60A1/DAYLIGHT/E27	300	1000	1/10/50	G	91859
100	240	E27	60	100A1/DAYLIGHT/E27	500	1000	1/10/50	G	91860
60	240	B22	60	60A1/DAYLIGHT/B22	300	1000	1/18	G	93052

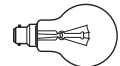
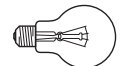

## LONGLIFE GLS LAMPS – Longer service lower maintenance

Watts	Volts	Cap	Diameter mm	Product Description	Lumens	Life (h)	Pack Qty	EEC	Product Code
clear									
40	240	E27	60	40A1/CL/LL/E27	300	2500	1/10/50	G	72696
60	240	E27	60	60A1/CL/LL/E27	540	2500	1/10/50	F	72694
75	240	E27	60	75A1/CL/LL/E27	730	2500	1/10/50	F	34917
100	240	E27	60	100A1/CL/LL/E27	1080	2500	1/10/50	F	34888
60	240	B22	60	60A1/CL/LL/B22	540	2500	1/10/50	F	34905
100	240	B22	60	75A1/CL/LL/B22	1080	2500	1/10/50	F	34887
frosted									
40	240	E27	60	40A1/FR/LL/E27	300	2500	1/10/50	G	72695
60	240	E27	60	60A1/FR/LL/E27	540	2500	1/10/50	F	72693
75	240	E27	60	75A1/FR/LL/E27	730	2500	1/10/50	F	34919
100	240	E27	60	100A1/FR/LL/E27	1080	2500	1/10/50	F	34893
60	240	B22	60	60A1/FR/LL/B22	540	2500	1/10/50	F	34908
75	240	B22	60	75A1/FR/LL/B22	730	2500	1/10/50	F	34918
100	240	B22	60	100A1/FR/LL/B22	1080	2500	1/10/50	F	34892

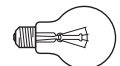

## EXTRA LONG LIFE GLS LAMPS – 5000–6000 HOURS – Last for a lifetime

Watts	Volts	Cap	Diameter mm	Product Description	Lumens	Life (h)	Pack Qty	EEC	Product Code
frosted									
60	230	E27	60	60A1/F/5000H/E27	590	5000	1/20	F	92766
40	240	E27	60	40A1/F/PL6KH E27	300	6000	1/10/100	G	18171
60	240	E27	60	60A1/F/PL6KH E27	500	6000	1/10/100	G	18188



# Incandescent lamps

## ENRICH™ – True natural colours

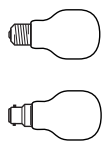

Watts	Volts	Cap	Diameter mm	Product Description	Lumens	Life (h)	Pack Qty	EEC	Product Code
40	230	E27	60	40A1/SL-ENRICH/E27	300	1000	2/20/40	G	91752
60	230	E27	60	60A1/SL-ENRICH/E27	510	1000	2/20/40	G	91753
100	230	E27	60	100A1/SL-ENRICH/E27	960	1000	2/20/40	G	91754
40	240	B22	60	40A1/SL-ENRICH/B22	300	1000	2/20	G	91755
60	240	B22	60	60A1/SL-ENRICH/B22	510	1000	2/20	G	91756
100	240	B22	60	100A1/SL-ENRICH/B22	960	1000	2/20	G	91757

## LINESTRA LAMPS – General linear lighting for home applications

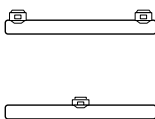

Watts	Volts	Cap	Diameter mm	Product Description	Lumens	Life (h)	Pack Qty	EEC	Product Code
opal									
35	230	2S14	30	35SL/O/300/2S14	220	2500	1/25	G	91487
60	230	2S14	30	60SL/O/500/2S14	420	2500	1/25	G	91488
35	230	S14	30	35SL/O/300/S14	220	2500	1/25	G	91505
60	230	S14	30	60SL/O/500/S14	420	2500	1/25	G	91486

## KRYPTON LAMPS – Slim shape for hanging fixtures



Watts	Volts	Cap	Diameter mm	Product Description	Lumens	Life (h)	Pack Qty	EEC	Product Code
Superbalux – Frosted/Opal									
25	230	E27	50	25MK1/S/E27	215	1000	1/10/50	E	91697
40	230	E27	50	40MK1/S/E27	390	1000	1/10/50	E	91085
60	230	E27	50	60MK1/S/E27	700	1000	1/10/50	E	91086
75	230	E27	55	75MK1/S/E27	900	1000	1/10/50	E	91698
100	230	E27	55	100MK1/S/E27	1320	1000	1/10/50	E	91124



opal									
25	230	E27	50	25MK1/O/E27	200	1000	1/10/50	F	91495
40	230	E27	50	40MK1/O/E27	380	1000	1/10/50	F	91494
60	230	E27	50	60MK1/O/E27	655	1000	1/10/50	E	91493
75	230	E27	55	75MK1/O/E27	865	1000	1/10/50	E	91492
100	230	E27	55	100MK1/O/E27	1200	1000	1/10/50	F	91536
40	230	B22	50	40MK1/O/B22	380	1000	1/10/50	F	91702
60	230	B22	50	60MK1/O/B22	655	1000	1/10/50	E	91701
75	230	B22	55	75MK1/O/B22	865	1000	1/10/50	E	33336
100	230	B22	55	100MK1/O/B22	1200	1000	1/10/50	F	91700



frosted									
40	230	E27	50	40MK1/FR/E27	425	1000	1/10/50	E	91121
60	230	E27	50	60MK1/FR/E27	730	1000	1/10/50	E	91122
75	230	E27	55	75MK1/FR/E27	965	1000	1/10/50	E	91699
100	230	E27	55	100MK1/FR/E27	1380	1000	1/10/50	E	91123



clear									
40	230	E27	50	40MK1/CL/E27	425	1000	1/10/50	E	91714
60	230	E27	50	60MK1/CL/E27	730	1000	1/10/50	E	91713
75	230	E27	55	75MK1/CL/E27	965	1000	1/10/50	E	91712
100	230	E27	55	100MK1/CL/E27	1380	1000	1/10/50	E	91711

## COMPUTER LIGHT – More relaxing for the eye



Watts	Volts	Cap	Diameter mm	Product Description	Lumens	Life (h)	Pack Qty	EEC	Product Code
40	230	E14	45	40D1/COMPUTER/E14	360	1000	1/10/50	F	91766
40	230	E27	60	40A1/T-COMPUTER/E27	400	1000	1/10/50	E	91762
60	230	E27	60	60A1/T-COMPUTER/E27	680	1000	1/10/50	E	91763
60	240	B22	60	60A1/T-COMPUTER/B22	660	1000	1/10/50	E	91765

## WEEKEND/INSECT LIGHT – Keeps flying insects away



Watts	Volts	Cap	Diameter mm	Product Description	Lumens	Life (h)	Pack Qty	EEC	Product Code
60	230	E27	60	60A1/WEEKEND/E27	200	1000	1/10/50	G	91129
100	230	E27	60	100A1/WEEKEND/E27	330	1000	1/20	G	22582



## Decorative lamps

---



Twisted Decor Lamp

## Decor:

GE offers new finishes and shapes to compliment the existing incandescent decorative range. They are specially designed to suit all environments and help to create different effects in interior situations like wall mounted fittings or chandeliers.

- Spherical Lamps
- Candles
- Globes
- Specialities  
(outdoor or coloured applications)

### Twisted candle

- Ideal to use in open fittings therefore enhancing atmosphere or creating lighting effects
- Available in 15-60W
- Cap selection: E14, E27, B22

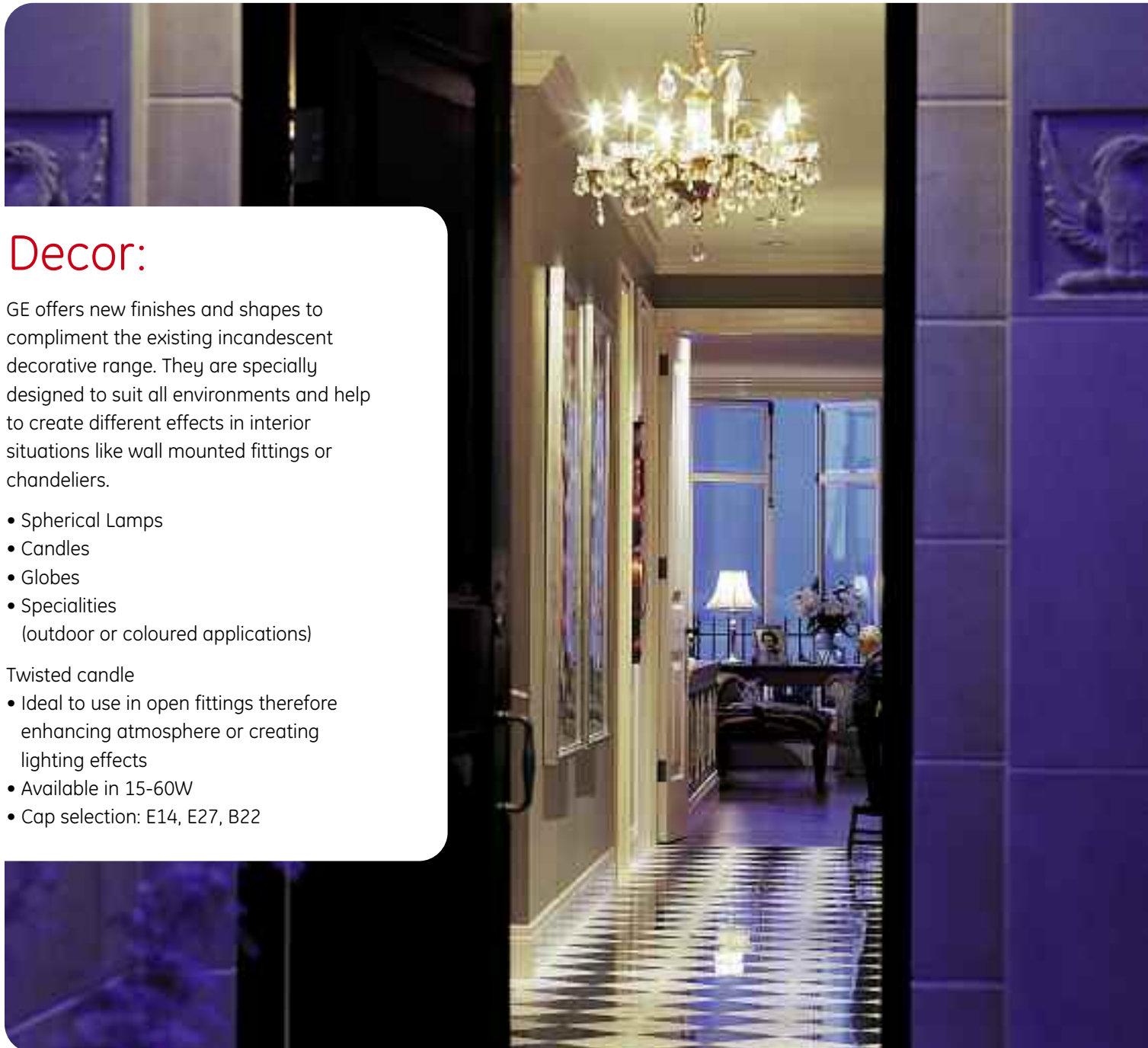

## SPHERICAL FAMILY Decorative round Lamps

Watts	Volts	Cap	Diameter mm	Product Description	Lumens	Life (h)	Pack Qty	EEC	Product Code
clear									
15	230	E14	45	15D1/CL/E14	90	1000	1/10/50	F	92002
25	230	E14	45	25D1/CL/E14	200	1000	10/100	F	19781
40	230	E14	45	40D1/CL/E14	400	1000	10/100	E	19788
60	230	E14	45	60D1/CL/E14	660	1000	10/100	E	19791
25	240	E14	45	25D1/CL/E14	200	1000	1/10/50	F	19775
40	240	E14	45	40D1/CL/E14	400	1000	1/10/50	E	19782
60	240	E14	45	60D1/CL/E14	660	1000	1/10/50	E	19784
15	230	E27	45	15D1/CL/E27	90	1000	1/10/50	F	91917
25	230	E27	45	25D1/CL/E27	200	1000	1/10/50	F	90564
40	230	E27	45	40D1/CL/E27	400	1000	1/10/50	E	90565
60	230	E27	45	60D1/CL/E27	660	1000	1/10/50	E	91593
15	230	B22	45	15D1/CL/B22	90	1000	1/10/50	F	91911
25	230	B22	45	25D1/CL/B22	200	1000	1/10/50	F	91987
40	230	B22	45	40D1/CL/B22	400	1000	1/10/50	E	91989
60	230	B22	45	60D1/CL/B22	660	1000	1/10/50	E	91991



frosted									
15	230	E14	45	15D1/FR/E14	90	1000	1/10/50	F	92003
25	230	E14	45	25D1/FR/E14	200	1000	10/100	F	19787
40	230	E14	45	40D1/FR/E14	400	1000	10/100	E	19789
60	230	E14	45	60D1/FR/E14	660	1000	10/100	E	19793
25	240	E14	45	25D1/FR/E14	200	1000	1/10/50	F	19777
40	240	E14	45	40D1/FR/E14	400	1000	1/10/50	E	19778
60	240	E14	45	60D1/FR/E14	660	1000	1/10/50	E	19786
15	230	E27	45	15D1/FR/E27	90	1000	1/10/50	F	90569
25	230	E27	45	25D1/FR/E27	200	1000	1/10/50	F	90566
40	230	E27	45	40D1/FR/E27	400	1000	1/10/50	E	90567
60	230	E27	45	60D1/FR/E27	660	1000	1/10/50	E	90568
15	230	B22	45	15D1/FR/B22	90	1000	1/10/50	F	91912
25	230	B22	45	25D1/FR/B22	200	1000	1/10/50	F	91988
40	230	B22	45	40D1/FR/B22	400	1000	1/10/50	E	91990
60	230	B22	45	60D1/FR/B22	660	1000	1/10/50	E	91594



## CROWN MIRRORED LAMPS – Directed light

Watts	Volts	Cap	Diameter mm	Product Description	Lumens	Life (h)	Pack Qty	EEC	Product Code
silver crown mirrored									
25	230	E14	45	25D1/SB/E14	150	1000	1/10/50	G	19796
40	230	E14	45	40D1/SB/E14	260	1000	1/10/50	G	18210
40	230	E27	60	40A1/SB/E27	290	1000	1/10/50	G	91130
60	230	E27	60	60A1/SB/E27	500	1000	1/10/50	G	91131
100	230	E27	60	100A1/SB/E27	1000	1000	1/50	G	22584
gold crown mirrored									
25	230	E14	45	25D1/GB/E14	130	1000	1/25	G	91918
40	230	E14	45	40D1/GB/E14	230	1000	1/5/50	G	90557
40	230	E27	60	40A1/GB/E27	260	1000	1/10/50	G	91135
60	230	E27	60	60A1/GB/E27	450	1000	1/10/50	G	91136

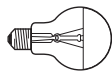

## T45 SOFTLIGHT ELEGANCE – Low glare in white and soft colors

Watts	Volts	Cap	Diameter mm	Product Description	Lumens	Life (h)	Pack Qty	EEC	Product Code
opal									
25	230	E14	45	25T45/SL/E14	175	1000	1/10/50	F	90563
40	230	E14	45	40T45/SL/E14	350	1000	1/10/50	F	90562
60	230	E14	45	60T45/SL/E14	600	1000	1/10/50	F	91952
rose									
40	230	E14	45	40T/SL-ROSE/E14	300	1000	1/20	G	90796
apricot									
40	230	E14	45	40T/SL-APRICOT/E14	320	1000	1/20	F	90797
gold • Dorée									
25	230	E14	45	25WSPH/CMRGold/E14	130	1000	1/25	G	91918



## CANDLE FAMILY CANDLE LAMPS – Favorite shape in chandeliers

Watts	Volts	Cap	Diameter mm	Product Description	Lumens	Life (h)	Pack Qty	EEC	Product Code
clear									
25	120/125	E14	35	25C1/CL/E14	220	1000	1/10/50	E	91676
40	120/125	E14	35	40C1/CL/E14	440	1000	1/10/50	E	91674
60	120/125	E14	35	60C1/CL/E14	720	1000	1/10/50	E	91678
25	230	E14	35	25C1/CL/E14	200	1000	1/10/50	F	90488
40	230	E14	35	40C1/CL/E14	400	1000	1/10/50	E	90487
60	230	E14	35	60C1/CL/E14	660	1000	1/10/50	E	90480
25	230	E27	35	25C1/CL/E27	200	1000	1/10/50	F	10870
40	230	E27	35	40C1/CL/E27	400	1000	1/10/50	E	10871
60	230	E27	35	60C1/CL/E27	660	1000	1/10/50	E	10873
frosted									
15	230	E14	35	15C1/FR/E14	90	1000	1/10/50	F	91346
25	230	E14	35	25C1/FR/E14	200	1000	1/10/50	F	91322
40	230	E14	35	40C1/FR/E14	400	1000	1/10/50	E	91323
60	230	E14	35	60C1/FR/E14	660	1000	1/10/50	E	91534
25	240	E14	35	25C1/FR/E14	200	1000	1/10/50	F	91680
40	240	E14	35	40C1/FR/E14	400	1000	1/10/50	E	91682
60	240	E14	35	60C1/FR/E14	660	1000	1/10/50	E	91683
25	230	B22	35	25C1/FR/B22	200	1000	1/10/50	F	91634
40	230	B22	35	40C1/FR/B22	400	1000	1/10/50	E	91636
60	230	B22	35	60C1/FR/B22	660	1000	1/10/50	E	91653
opal									
25	230	E27	35	25C1/O/E27	180	1000	1/10/50	F	10875
40	230	E27	35	40C1/O/E27	360	1000	1/10/50	F	10877
60	230	E27	35	60C1/O/E27	600	1000	1/10/50	F	10878







## SOFTLIGHT ELEGANCE – Low glare in white and soft colours

Watts	Volts	Cap	Diameter mm	Product Description	Lumens	Life (h)	Pack Qty	EEC	Product Code
opal									
25	230	E14	35	25C1/SL/E14	180	1000	1/10/50	F	90483
40	230	E14	35	40C1/SL/E14	360	1000	1/10/50	F	90482
60	230	E14	35	60C1/SL/E14	600	1000	1/10/50	F	90481





## DECOR CANDLE LAMPS - Eye catching design

Watts	Volts	Cap	Diameter mm	Product Description	Lumens	Life (h)	Pack Qty	EEC	Product Code	
twisted candles										
clear										
	15	230	E14	35	15TC1/CL/E14	90	1000	1/10/50	F	10823
	25	230	E14	35	25TC1/CL/E14	200	1000	1/10/50	F	10826
	40	230	E14	35	40TC1/CL/E14	400	1000	1/10/50	E	10827
	60	230	E14	35	60TC1/CL/E14	660	1000	1/10/50	E	10828
	25	240	B22	35	25TC1/CL/B22	200	1000	1/10/50	F	91734
twisted candles frosted										
	15	230	E14	35	15TC1/FR/E14	90	1000	1/10/50	F	10830
	25	230	E14	35	25TC1/FR/E14	200	1000	1/10/50	F	10831
	40	230	E14	35	40TC1/FR/E14	400	1000	1/10/50	E	10832
	60	230	E14	35	60TC1/FR/E14	660	1000	1/10/50	E	10833
bent-tip candles										
frosted										
	25	230	E14	35	25C1/BentTip/Fr/E14	200	1000	1/25	F	27148
	40	230	E14	35	40C1/BentTip/Fr/E14	400	1000	1/25	E	27151
	25	240	B22	35	25C1/BentTip/Fr/B22	200	1000	1/25	F	27182
	40	240	B22	35	40C1/BentTip/Fr/B22	400	1000	2/12	E	27166
	40	240	E14	35	40C1/BentTip/Fr/E14	400	1000	2/12	E	27171
	60	240	B22	35	60C1/BentTip/Fr/B22	660	1000	2/12	E	27172
	60	240	E14	35	60C1/BentTip/Fr/E14	660	1000	2/12	E	27176
clear										
	25	240	B22	35	25C1/BentTip/Cl/B22	200	1000	1/25	F	27177
	40	240	B22	35	40C1/BentTip/Cl/B22	400	1000	2/12	E	27158
	40	240	B15	35	40C1/BentTip/Cl/B15	400	1000	2/12	E	27160
	40	240	E14	35	40C1/BentTip/Cl/E14	400	1000	2/12	E	27190
	60	240	B22	35	60C1/BentTip/Cl/B22	660	1000	2/12	E	27162
	60	240	B15	35	60C1/BentTip/Cl/B15	660	1000	2/12	E	27164
	60	240	E14	35	60C1/BentTip/Cl/E14	660	1000	2/12	E	27192

## GLOBE FAMILY

### SOFTLIGHT GLOBE LAMPS - Soft decor finishes in giant sizes

Watts	Volts	Cap	Diameter mm	Product Description	Lumens	Life (h)	Pack Qty	EEC	Product Code	
opal - ø 60 mm										
	25	230	E14	60	25G60/O/E14	160	2000	1/25	G	91099
	40	230	E14	60	40G60/O/E14	290	2000	1/25	G	91100
	60	230	E14	60	60G60/O/E14	490	2000	1/25	G	91158
	40	230	E27	60	40G60/O/E27	290	2000	1/25	G	91143
	60	230	E27	60	60G60/O/E27	490	2000	1/25	G	91144
opal - ø 80 mm										
	40	230	E27	80	40G80/O/E27	290	2000	1/20	G	91104
	60	230	E27	80	60G80/O/E27	490	2000	1/20	G	91109
	100	230	E27	80	100G80/O/E27	890	2000	1/20	G	91147

## GLOBE FAMILY continued

### SOFTLIGHT GLOBE LAMPS - Soft decor finishes in giant sizes

Watts	Volts	Cap	Diameter mm	Product Description	Lumens	Life (h)	Pack Qty	EEC	Product Code
opal - ø 95 mm									
40	230	E27	95	40G95/O/E27	290	2000	1/20	G	91115
60	230	E27	95	60G95/O/E27	490	2000	1/20	G	91116
75	230	E27	95	75G95/O/E27	650	2000	1/20	G	91458
100	230	E27	95	100G95/O/E27	890	2000	1/20	G	91117
opal - ø 125 mm									
60	230	E27	125	60G125/O/E27	490	2000	1/20	G	91093
100	230	E27	125	100G125/O/E27	890	2000	1/20	G	91095
150	230	E27	125	150G125/O/E27	1360	2000	1/20	G	91244
Eldea opal									
25	230	E14	72	25ELDEA/O/E14	160	2500	1/25	G	92604
40	230	E14	72	40ELDEA/O/E14	350	2500	1/25	F	92605
Elroyal opal									
40	230	E27	61	40ELROYAL/O/E27	360	2500	1/25	F	32897

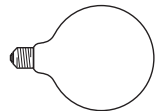
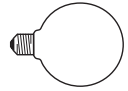

## SPECIALITY FAMILY – For party decoration and other applications

### Coloured General Lighting Service

Watts	Volts	Cap	Diameter mm	Product Description	Lumens	Life (h)	Pack Qty	EEC	Product Code
red									
15	230	E27	60	15A1/R/E27	N/A	1000	1/10/50	N/A	91930
25	230	E27	50	25A1/R/E27	N/A	1000	1/10/120	N/A	90922
40	230	E27	50	40A1/R/E27	N/A	1000	1/10/50	N/A	41336
orange									
15	230	E27	60	15A1/O/E27	N/A	1000	1/10/50	N/A	91929
25	230	E27	50	25A1/O/E27	N/A	1000	1/10/120	N/A	90923
40	230	E27	50	40A1/O/E27	N/A	1000	1/10/50	N/A	41315
yellow									
15	230	E27	60	15A1/Y/E27	N/A	1000	1/10/50	N/A	91931
25	230	E27	50	25A1/Y/E27	N/A	1000	1/10/120	N/A	90921
40	230	E27	50	40A1/Y/E27	N/A	1000	1/10/50	N/A	41337
60	230	E27	60	60A1/Y/E27	N/A	1000	1/10/50	N/A	91935
green									
15	230	E27	60	15A1/G/E27	N/A	1000	1/10/50	N/A	91928
25	230	E27	50	25A1/G/E27	N/A	1000	1/10/120	N/A	90920
40	230	E27	50	40A1/G/E27	N/A	1000	1/10/50	N/A	41347
60	230	E27	60	60A1/G/E27	N/A	1000	1/10/50	N/A	91942
blue									
15	230	E27	60	15A1/B/E27	N/A	1000	1/10/50	N/A	91927
25	230	E27	50	25A1/B/E27	N/A	1000	1/10/120	N/A	90924
60	230	E27	60	60A1/B/E27	N/A	1000	1/10/50	N/A	91932

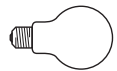

# Incandescent lamps

## Coloured Decorative Round Lamps



Watts	Volts	Cap	Diameter mm	Product Description	Lumens	Life (h)	Pack Qty	EEC	Product Code
red									
15	230	E14	45	15D1/R/E14	N/A	1000	1/10/50	N/A	90525
15	230	E27	45	15D1/R/E27	N/A	1000	1/10/50	N/A	90531
orange									
15	230	E27	45	15D1/O/E27	N/A	1000	1/10/50	N/A	90528
yellow									
15	230	E14	45	15D1/Y/E14	N/A	1000	1/10/50	N/A	90526
15	230	E27	45	15D1/Y/E27	N/A	1000	1/10/50	N/A	90527
green									
15	230	E14	45	15D1/G/E14	N/A	1000	1/10/50	N/A	92004
15	230	E27	45	15D1/G/E27	N/A	1000	1/10/50	N/A	91521
blue									
15	230	E14	45	15D1/B/E14	N/A	1000	1/10/50	N/A	92001
15	230	E27	45	15D1/B/E27	N/A	1000	1/10/50	N/A	91522

## Coloured Candle Lamps



Watts	Volts	Cap	Diameter mm	Product Description	Lumens	Life (h)	Pack Qty	EEC	Product Code
red									
15	230	E14	35	25C1/R/E14	N/A	1000	1/10/50	N/A	90525
yellow									
25	230	E14	35	25C1/Y/E14	N/A	1000	1/10/50	N/A	90526
green									
25	230	E14	35	25C1/G/E14	N/A	1000	1/10/50	N/A	92004
blue									
25	230	E14	35	25C1/B/E14	N/A	1000	1/10/50	N/A	92001

## Coloured PYGMY Lamps



Watts	Volts	Cap	Diameter mm	Product Description	Lumens	Life (h)	Pack Qty	EEC	Product Code
blue									
15	240	E14	28	15P1/B/E14	N/A	1000	1/50	N/A	12318
green									
15	240	E14	28	15P1/G/E14	N/A	1000	1/50	N/A	12587
red									
15	240	E14	28	15P1/R/E14	N/A	1000	1/50	N/A	12585
yellow									
15	240	E14	28	15P1/Y/E14	N/A	1000	1/50	N/A	12586



## Reflector lamps

---

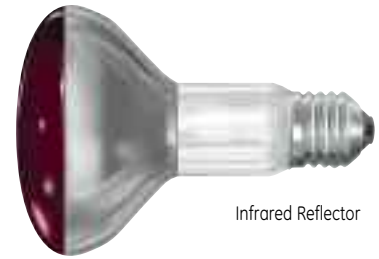

Infrared Reflector

GE Reflector lamps are constructed from blown glass bulbs with an interior mirror finish which directs light more efficiently to the required area or item to be illuminated.

- Reflector R39-R95
- PAR Reflector lamps
- Enrich lamps
- Long life Reflector lamps
- Infralamps
- Coloured Reflector lamps (e.g. disco)

## Infrared Reflector lamps

These Infrared Reflector lamps convert power into clean, simple and convenient sources of radiant heat. Typical applications range from livestock raising, to industrial drying processes where the control and uniformity of heat distribution is advantageous.





## Spot Reflector

- Available in White Satin or in different colors (Disco)
- Sizes are: R39, R50, R63, R80, R95
- E14/E27/B22 caps available
- In 25W-30W-40W-60W-75W-100W types



# Incandescent lamps



## REFLECTOR LAMPS – Spot lighting directs light

	Watts	Volts	Cap	Diameter mm	Product Description	Lumens	Candela	Life (h)	Pack Qty	EEC	Product Code
	ø 39 mm										
	25	230	E14	39	25R39/E14	N/A	65	1000	1/10/100	N/A	91523
	30	230	E14	39	30R39/E14	N/A	80	1000	10/100	N/A	91524
	ø 50 mm										
	25	230	E14	50	25R50/E14	N/A	130	1000	10/50	N/A	92373
	40	230	E14	50	40R50/E14	N/A	250	1000	10/50	N/A	92366
	ø 63 mm										
	60	120/125	E27	63	60R63/E27	N/A	720	1000	1/10/40	N/A	92130
	40	230	E27	63	40R63/E27	N/A	350	1000	10/40	N/A	91079
	ø 80 mm										
	40	230	E27	80	40R80/E27	N/A	140	1000	1/10	N/A	92858
	60	230	E27	80	60R80/E27	N/A	240	1000	1/10	N/A	92839
	ø 95 mm										
	75	230	E27	95	75R95/E27	N/A	1000	1000	1/32	N/A	91351
	100	230	E27	95	100R95/E27	N/A	1350	1000	1/32/	N/A	91366
	150	230	E27	95	150R95/E27	N/A	2000	1000	1/32	N/A	91367

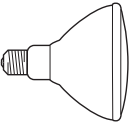

## PAR 38 Reflector Watt-Miser™ – Energy efficient and outdoor applications

	Watts	Volts	Cap	Diameter mm	Product Description	Lumens	Candela	Life (h)	Pack Qty	EEC	Product Code
	spot clear										
	60	230	E27	122	60PAR/SP/E27	N/A	3400	2000	1/12	N/A	91572
	80	230	E27	122	80PAR/SP/E27	N/A	5400	2000	1/12	N/A	91577
	120	230	E27	122	120PAR/SP/E27	N/A	9300	2000	1/12	N/A	91576
	flood clear										
	60	230	E27	122	60PAR/FL/E27	N/A	1200	2000	1/12	N/A	91575
	80	230	E27	122	80PAR/FL/E27	N/A	1800	2000	1/12	N/A	91574
	120	230	E27	122	120PAR/FL/E27	N/A	3100	2000	1/12	N/A	91573

## ENRICH REFLECTOR LAMPS – True natural colours

	Watts	Volts	Cap	Diameter mm	Product Description	Lumens	Candela	Life (h) Qty	Pack	EEC	Product Code
	ø 50 mm										
	25	230	E14	50	25R50/E14/230V/ENRICH	N/A	N/A	1000	1/25	N/A	91392
	40	230	E14	50	40R50/E14/230V/ENRICH	N/A	N/A	1000	1/25	N/A	91393
	ø 63 mm										
	60	230	E27	63	60R63/E27/230V/ENRICH	N/A	N/A	1000	1/25	N/A	91340
	ø 80 mm										
	60	230	E27	80	60R80/E27/230V/ENRICH	N/A	N/A	1000	1/20	N/A	91344
	100	230	E27	80	100R80/E27/230V/ENRICH	N/A	N/A	1000	1/20	N/A	91345

## LONG LIFE REFLECTOR LAMPS – Longer service lower maintenance

	Watts	Volts	Cap	Diameter mm	Product Description	Lumens	Candela	Life (h) Qty	Pack	EEC	Product Code
	Pluslife ø 63 mm										
	40	240	E27	63	40R63/PL/E27	N/A	300	3500	1/10	N/A	47978
	60	240	E27	63	60R63/PL/E27	N/A	450	3500	1/10	N/A	42831
	ø 80 mm										
	60	240	E27	80	60R80/PL/E27	N/A	200	3500	1/10	N/A	42830
	100	240	E27	80	100R80/PL/E27	N/A	400	3500	1/10	N/A	42837



## Infrared Reflector Lamps – Heating and healing

Watts	Volts	Cap	Diameter mm	Product Description	Lumens	Candela	Life (h) Qty	Pack	EEC	Product Code
Infrared PAR 38										
100	240	E27	122	100PAR/IR/E27	N/A	N/A	5000	1/10	N/A	92060
175	240	E27	122	175PAR/IR/E27	N/A	N/A	5000	1/10	N/A	91542
Infrared reflector – clear										
150	235/245	E27	125	150R/IR/CL/E27	N/A	N/A	5000	1/9	N/A	28720
250	235/245	E27	125	250R/IR/CL/E27	N/A	N/A	5000	1/9	N/A	28724
275	235/245	E27	125	275R/IR/CL/E27	N/A	N/A	5000	1/9	N/A	32569
Infrared reflector – red										
150	240	E27	125	150R/IR/R/E27	N/A	N/A	5000	1/10	N/A	91372
250	240	E27	125	250R/IR/R/E27	N/A	N/A	5000	1/10	N/A	91391
Infrared reflector – satin										
150	240	E27	125	150R/IR/SA/E27	N/A	N/A	5000	1/10	N/A	91288
250	240	E27	125	250R/IR/SA/E27	N/A	N/A	5000	1/10	N/A	91390
275	235/245	E27	125	275R/IR/SA/E27	N/A	N/A	5000	1/9	N/A	32296

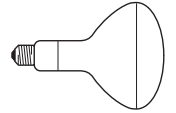
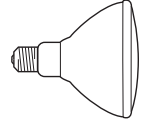

## COLOURED REFLECTOR LAMPS – Decorative spot lighting

Watts	Volts	Cap	Diameter mm	Product Description	Lumens	Candela	Life (h) Qty	Pack	EEC	Product Code
Reflector Disco ø 50 mm										
red										
40	230	E14	50	40R50/R/E14	N/A	N/A	1000	1/25	N/A	91386
yellow										
40	230	E14	50	40R50/Y/E14	N/A	N/A	1000	1/25	N/A	91388
green										
40	230	E14	50	40R50/G/E14	N/A	N/A	1000	1/25	N/A	91389
blue										
40	230	E14	50	40R50/B/E14	N/A	N/A	1000	1/25	N/A	91387
ø 63 mm										
red										
40	230	E27	63	40R63/R/E27	N/A	N/A	1000	1/25	N/A	91532
yellow										
40	230	E27	63	40R63/Y/E27	N/A	N/A	1000	1/25	N/A	91531
green										
40	230	E27	63	40R63/G/E27	N/A	N/A	1000	1/25	N/A	91533
blue										
40	230	E27	63	40R63/B/E27	N/A	N/A	1000	1/25	N/A	91530
ø 80 mm										
red										
60	230	E27	80	60R80/R/E27	N/A	N/A	1000	1/40	N/A	91528
yellow										
60	230	E27	80	60R80/Y/E27	N/A	N/A	1000	1/40	N/A	91527
green										
60	230	E27	80	60R80/G/E27	N/A	N/A	1000	1/40	N/A	91526
blue										
60	230	E27	80	60R80/B/E27	N/A	N/A	1000	1/40	N/A	91525
PAR 38 Colorplus										
red										
80	230	E27	122	80PAR/FL/R/E27	N/A	N/A	2000	1/12	N/A	91540
yellow										
80	230	E27	122	80PAR/FL/Y/E27	N/A	N/A	2000	1/12	N/A	91539
green										
80	230	E27	122	80PAR/FL/G/E27	N/A	N/A	2000	1/12	N/A	91543
blue										
80	230	E27	122	80PAR/FL/B/E27	N/A	N/A	2000	1/12	N/A	91578

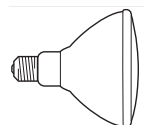
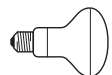
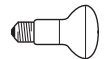

# Incandescent lamps

## Pygmy/Tubular lamps

---



Designed to be used in confined spaces of housing or industrial applications.

- Fridge lamps
- Oven lamps
- Cooker hood lamps
- Sewing machine lamps
- Tubular lamps



## Pygmy Lamps

Watts	Volts	Cap	Diameter mm	Product Description	Lumens	Life (h)	Pack Qty	EEC	Product Code
clear									
15	110	E14	28	15P1/CL/E14	90	1000	1/50	F	31821
15	110	B15	28	15P1/CL/B15	90	1000	1/50	F	31816
15	110	B22	28	15P1/CL/B22	90	1000	1/50	F	31811
15	230	E14	28	15P1/CL/E14	90	1000	1/50	F	12512
25	230	E14	28	25P1/CL/E14	190	1000	10/50	F	91955
25	230	E14	28	25P1/CL/E14	190	1000	500	F	37916
15	240	E14	28	15P1/CL/E14	90	1000	1/10/50	F	91950
15	240	B15	28	15P1/CL/B15	90	1000	1/10/50	F	91780
15	240	B22	28	15P1/CL/B22	90	1000	1/10/50	F	91948
25	240	E14	28	25P1/CL/E14	190	1000	1/10/50	F	34420
25	240	B22	28	25P1/CL/B22	190	1000	1/10/50	F	34422
frosted									
15	230	E14	26	15P1/FR/E14	90	1000	1/10/50	F	92047
25	230	E14	28	25P1/FR/E14	190	1000	1/10/50	F	92048



## Fridge Lamps

Watts	Volts	Cap	Diameter mm	Product Description	Lumens	Life (h)	Pack Qty	EEC	Product Code
clear fridge									
15	230	E14	26	15P1/CL/E14	90	1000	10/50	F	92046
15	230	E14	26	15P1/CL/E14	90	1000	500	F	149052



## Oven Lamps

Watts	Volts	Cap	Diameter mm	Product Description	Lumens	Life (h)	Pack Qty	EEC	Product Code
clear oven									
15	230-240	E14	22	15P1/CL/E14 OVEN	85	1000	1/50	F	12447
25	230	E14	26	25P1/CL/E14 OVEN	190	1000	1/50	G	43381
25	230	E27	45	25D1/CL/E27 OVEN	142	300	1/10/100	G	12513
40	230	E14	45	40D1/CL/E14 OVEN	320	300	1/10/50	F	12462
40	230	E27	45	40D1/CL/E27 OVEN	320	300	1/10/100	F	12515



## TUBULAR T25 LAMPS – Cooker hoods, painting or furniture lighting

Watts	Volts	Cap	Diameter mm	Product Description	Lumens	Life (h)	Pack Qty	EEC	Product Code
15	230	E14	25	15T25/CL/E14	90	1000	1/50	F	13118
25	230	E14	25	25T25/CL/E14	190	1000	1/50	F	13119



## TUBULAR T28 LAMPS – Cooker hoods, painting or furniture lighting

Watts	Volts	Cap	Diameter mm	Product Description	Lumens	Life (h)	Pack Qty	EEC	Product Code
clear									
25	230	E14	28	25T28/CL/E14	200	1000	1/50	F	13109
40	230	E14	28	40T28/CL/E14	400	1000	1/50	E	13110
60	230	E14	28	60T28/CL/E14	660	1000	1/50	E	13111
opal									
40	230	E14	28	40T28/O/E14	400	1000	2/20	E	17688
60	230	E14	28	60T28/O/E14	660	1000	2/20	E	17690



# Incandescent lamps

Incandescent lamps  
for special application



Traffic Lights Lamp

These lamps are ideal for tough conditions in special application areas such as:

- Rough service
- Traffic lights
- Extra Low Volt lamps



## Rough Service Lamps

Watts	Volts	Cap	Diameter mm	Product Description	Lumens	Life (h)	Pack Qty	EEC	Product Code
frosted									
60	120	E27	60	60A1/FR/RS/E27	450	1500	1/20	G	31546
100	120	E27	60	100A1/FR/RS/E27	840	3000	1/20	G	31573
40	230/240	E27	60	40A1/FR/RS/E27	250	3000	1/20	G	91228
60	230/240	E27	60	60A1/FR/RS/E27	500	3000	1/20	G	91229
100	230/240	E27	60	100A1/FR/RS/E27	880	3000	1/20	G	91227
40	120	B22	60	40A1/FR/RS/B22	300	1500	1/20	G	31519
60	120	B22	60	60A1/FR/RS/B22	450	3000	1/20	G	31535
100	120	B22	60	100A1/FR/RS/B22	840	3000	1/20	G	31560
100	230/240	B22	60	100A1/FR/RS/B22	880	3000	1/20	G	92018

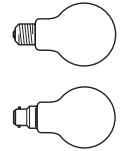

## Traffic Lights

Watts	Volts	Cap	Diameter mm	Product Description	Lumens	Life (h)	Pack Qty	EEC	Product Code
clear									
40	230	E27	60	40A1/CL/E27	230	3000	1/10/100	G	35218
70	230	E27	60	70A1/CL/E27	420	3000	1/10/100	G	35238
60	230	E27	60	60A1/CL/E27	380	3000	1/10/100	G	35239
100	230	E27	60	100A1/CL/E27	830	3000	1/10/10	G	22620
40	230	E27	60	40A1/EXTERIOR/CL/E27	230	3000	1/15	G	91293
60	230	E27	60	60A1/EXTERIOR/CL/E27	380	3000	1/15	G	91294

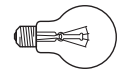

## Low & Extra Low Voltage GLS Lamps

Watts	Volts	Cap	Diameter mm	Product Description	Lumens	Life (h)	Pack Qty	EEC	Product Code
frosted									
40	24	E27	60	24V40/FR/E27	570	1000	1/10/100	D	91874
60	24	E27	60	24V60/FR/E27	900	1000	1/10/100	D	91875
100	24	E27	60	24V100/FR/E27	1700	1000	1/10/100	D	91873
60	42	E27	60	42V60/FR/E27	840	1000	10/100	D	29051
clear									
25	24	E27	60	24V25/CL/E27	300	1000	1/10/100	D	35178
40	24	E27	60	24V40/CL/E27	570	1000	1/10/100	D	91876
60	24	E27	60	24V60/CL/E27	900	1000	1/10/100	D	91877
100	24	E27	60	24V100/CL/E27	1700	1000	1/10/100	D	35174
40	24	B22	60	24V40/CL/B22	570	1000	1/10/100	D	91879
60	24	B22	60	24V60/CL/B22	900	1000	1/10/100	D	91878

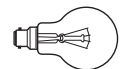
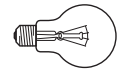
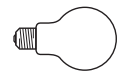

## Halogen lamps

# GE invented and launched the world's first halogen lamp in 1958.

Halogen lamps provide outstanding light quality – the crisp white light delivers superior colour reproduction.

They are more energy efficient than conventional incandescent lamps and offer a longer life – all within a compact size.

Other features include outstanding beam control, UV control, heat reflective coatings that protect display items.



## Content

Precise™ ConstantColor™ MR16	34
Precise™ Bright MR16	35
Standard MR16	36
Precise™ Alutech™ MR16	36
MR16 START	36
MR16 IR	36
Precise™ MR11	37
MR11 Start	37
AR 111	38
Low Voltage Halogen Capsules	40
Low Voltage Halogen Capsules Start	40
MR16 Mains Tech	42
MR20 Mains Tech	42
MR16 Mains Start	42
MR16 Mains Start Dichroic	42
R16 Mains Start Coloured	42
Single Ended Mains Voltage Capsules	44
Double Ended Mains Voltage Capsules	45
Halogen PAR Lamps	46
HaloGlobe™	48
HaloGLS™	48
HaloCandle	48
Twisted Candle	48
HaloSpherical	48
HaloReflector	49
Halo BTT™	49
Halo Tubular	49
Halo T38	49
General information	50



# Halogen lamps

## Product identification

The following glossary of terms and descriptions can help you when checking halogen lamp specifications and explains how to use the product codes when ordering products. Within each product line, lamps are divided into families – within families, lamps are listed by wattage.

**Watts:** Energy used. To find actual energy used (kWh) multiply power (watts shown) x hours of use divided by 1000

**Beam Spread Degrees:** The angle of the cone of light produced by a reflector lamp at 50% of its intensity

**Product Code:** It is important to use this code when ordering to ensure that you receive the exact product you require

**Volts:** Each lamp's voltage is listed

**Product Description:** The lamp's identification code

**Length:** Expressed in mm

**Pack Quantity:** The number of lamps in one box

**Precise™ MR16 ConstantColor™ – UV Control**

Watts	Volts	Product Description	Cap	Length	Diameter	Beam angle	Candela	CCT (K)	Life(h)	Pack Qty	EE Class	Product Code
ø 50 mm – open dichroic mirror												
75	12	EYF/CC	GU5.3	46	50.7	15	11500	3050	4000	10	-	20843
75	12	EYJ/CC	GU5.3	46	50.7	25	5500	3050	4000	10	-	20841
75	12	EYC/CC	GU5.3	46	50.7	42	2000	3050	4000	10	-	20840

**Lamp:** Description of lamp type, and product features

**Cap:** The type of cap fitted

**Energy Efficiency Class:** Energy saving code

**Peak Beam Candelas:** Luminous intensity of the lamp beam expressed in candelas

**Rated Average Life:** The point in time when 50% of installed lamps are still burning

**EYC/CC**

ANSI – Code

Product Feature, eg. Cover glass

**CCT K:** Colour temperature – Kelvin. The visual warmth or coolness of the light. The higher the number the whiter or cooler the light appears



## Precise™ MR16 & MR11

If you're looking for halogen, aim for a Precise™ solution

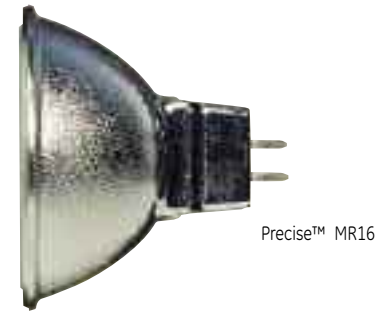
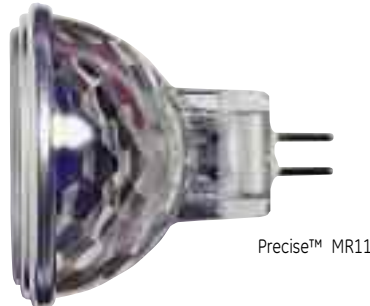

- **Cool, white light,** precise beam control, excellent colour performance and a lamp life of up to 6,000 hours.
- **Ideal for** retail display lighting, decorative lighting and spotlighting of individual features – including heat sensitive items.
- **A wide range of** beam angles and select Precise™ MR16 lamps for ultra – violet control.

### Choose:

#### **Precise™ ConstantColor™ MR16**

for consistent light quality and exceptional long life.

#### **Precise™ Bright MR16**

for outstanding light output in a mid range lamp.

#### **Precise™ Alutech™ MR16**

for all your heat sensitive halogen fixtures.

#### **Precise™ Bright MR11**

for high output, light quality and long life in an extra compact form.

### Range of beam angles

GE Precise™ MR16 lamps offer a choice of nominal beam angles from 8° to 60°. The range of beam angles can be used to either highlight single features with a tight focus to provide a wash of ambient lighting and a variety of effects achievable with intermediate beams.

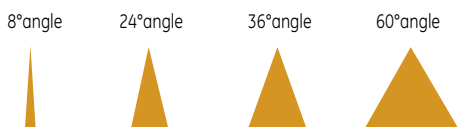

### Applications:

- Retail display lighting
- Decorative lighting and
- Spotlighting of individual features.

# Halogen lamps

## Low voltage

### Precise™ ConstantColor™ MR16

A long lasting premium quality halogen lamp, the Precise™ ConstantColor™ lamp features revolutionary GE Thin Film Technology to give consistent light output for the 6000 hour life of the lamp. The advanced coating is designed to withstand temperatures of up to 500°C, making it the ideal choice for long-term reliability and consistent light quality.



Precise™  
ConstantColor™  
MR16

### Precise™ Bright MR16

Precise™ Bright sets new performance standards offering outstanding long life, light output and beam quality. Its advanced, computer-designed reflector gives a smooth beam and outstanding light output compared to similar lamps. Precise™ Bright is available in both open and closed forms.



Precise™ Bright  
MR16

### Precise™ Alutech™ MR16

The perfect choice for heat sensitive halogen fixtures. For many years finding a halogen lamp suitable for high technology electronic fixtures was a problem. Precise™ Alutech is the answer. With a GE developed aluminium coating, almost all of the heat is reflected away from the fixture. Throwing heat forward has advantages in downlighters like minimising heat build up in ceiling voids.



Precise™  
Alutech™ MR16

### Precise™ Bright MR11

The extra compact, high performance halogen lamp GE Precise™ Bright MR11 packs the high output, light quality and long life of halogen into an extra compact form, making it ideal where space is at a premium.



Precise™  
Bright MR11

### AR111

The GE AR111 Aluminium faceted reflector for a better beam control has been designed to direct light and heat forward to ensure full protection for the gear. AR111 provides bright and white halogen quality of light (up to 2950K) especially suitable for decorative and architectural lighting.



AR111



## Halogen lamps Low voltage



- Up to 6000 hours life
- 98–99% lumen maintenance
- Double sided dichroic coating
- With UV control
- The most consistent light output available



- Up to 4000 hours life
- Outstanding light output and beam quality
- Upgraded reflector
- UV control in both open and closed forms



- Heat reflected forward
- Ideal for heat sensitive fixtures
- 3000 hours life
- With UV control



- Extra-compact 35 mm size – perfect for lighting cabinet displays
- 3500 hours life
- Closed lamps with UV control



- Metal cap over filament to avoid direct glare effect and hot point
- UV-block to reduce bleaching effect
- Long life up to 3,000 hours
- 75%+ lumen maintenance to lower maintenance costs

# Halogen lamps

## Low voltage

### Precise™ MR16 ConstantColor™ – UV Control

Watts	Volts	Product Description	Cap	Length mm	Diameter mm	Beam angle	Candela	CCT (K)	Lifel(h)	Pack Qty	Product Code
ø 50 mm – open dichroic mirror											
71	12	EYF/CC	GU5.3	46	50.7	15	11500	3050	4000	10	20843
71	12	EYJ/CC	GU5.3	46	50.7	25	5500	3050	4000	10	20841
71	12	EVC/CC	GU5.3	46	50.7	42	2000	3050	4000	10	20840
ø 50 mm – closed dichroic mirror											
20	12	ESX/CG	GU5.3	50.5	50.7	15	3150	2900	5000	10	20858
20	12	BAB/CG	GU5.3	50.5	50.7	40	475	2900	5000	10	20857
35	12	FRB/CG	GU5.3	50.5	50.7	12	7500	3050	5000	10	20864
35	12	FRA/CG	GU5.3	50.5	50.7	20	3200	3000	5000	10	20860
35	12	FMW/CG	GU5.3	50.5	50.7	40	900	3000	5000	10	20859
50	12	EXT/CG	GU5.3	50.5	50.7	14	8400	3050	6000	10	20872
50	12	EXZ/CG	GU5.3	50.5	50.7	25	2900	3050	6000	10	20871
50	12	EXN/CG	GU5.3	50.5	50.7	40	1500	3050	6000	10	20867
50	12	FNV/CG	GU5.3	50.5	50.7	55	850	3050	6000	10	20865
71	12	EYF/CG	GU5.3	50.5	50.7	15	10400	3050	4000	10	20876
71	12	EYJ/CG	GU5.3	50.5	50.7	25	4550	3050	4000	10	20874
71	12	EVC/CG	GU5.3	50.5	50.7	40	2000	3050	4000	10	20873



	20W		35W		50W		71W	
m	ESX/CG 12° Øm	lux	FRB/CG 12° Øm	lux	EXT/CG 14° Øm	lux	EYF/CG 15° Øm	lux
1	0.21	3150	0.21	7500	0.25	8400	0.26	11500
2	0.42	788	0.42	1875	0.49	2100	0.53	2875
3	0.63	350	0.63	833	0.74	933	0.79	1278
4	0.84	197	0.84	469	0.98	525	1.05	719
5	1.05	126	1.05	300	1.23	336	1.32	460
m	FRA/CG 20° Øm		EXZ/CG 25° Øm		EYJ/CG 25° Øm			
1	0.35		0.44		0.44			
2	0.71		0.89		0.89			
3	1.06		1.33		1.33			
4	1.41		1.77		1.77			
5	1.76		2.22		2.22			
m	BAB/CG 40° Øm		FMW/CG 40° Øm		EXN/CG 40° Øm		EVC/CG 40° Øm	
1	0.73		0.73		0.73		0.73	
2	1.46		1.46		1.46		1.46	
3	2.18		2.18		2.18		2.18	
4	2.91		2.91		2.91		2.91	
5	3.64		3.64		3.64		3.64	
m	FNV/CG 55° Øm							
1	1.04							
2	2.08							
3	3.12							
4	4.16							
5	5.21							



## Precise™ Bright MR16 – UV Control

Watts	Volts	Product Description	Cap	Length mm	Diameter mm	Beam angle	Candela	CCT (K)	Lifel(h)	Pack Qty	Product Code
ø 50 mm – open dichroic mirror											
20	12	M69/BAB	GU5.3	46	50.7	36	480	3000	4000	10	88231
35	12	M70/FRA	GU5.3	46	50.7	18	3210	2900	4000	10	88228
35	12	M81/FMW	GU5.3	46	50.7	36	1390	2900	4000	10	88229
50	12	M50/EXZ	GU5.3	46	50.7	18	5080	3000	4000	10	88233
50	12	M58/EXN	GU5.3	46	50.7	36	2250	3000	4000	10	88234
50	12	M80/FNV	GU5.3	46	50.7	60	1070	3000	4000	10	88232



ø 50 mm – closed dichroic mirror											
20	12	M268/ESX/CG	GU5.3	50.5	50.7	8	4000	2800	4000	10	88226
20	12	M269/BAB/CG	GU5.3	50.5	50.7	36	450	2800	4000	10	88235
35	12	M270/FRA/CG	GU5.3	50.5	50.7	18	3000	2900	4000	10	88230
35	12	M281/FMW/CG	GU5.3	50.5	50.7	36	1300	2900	4000	10	88236
50	12	M249/EXT/CG	GU5.3	50.5	50.7	8	8000	3000	4000	10	88227
50	12	M250/EXZ/CG	GU5.3	50.5	50.7	18	4750	3000	4000	10	88237
50	12	M258/EXN/CG	GU5.3	50.5	50.7	36	2100	3000	4000	10	88239
50	12	M280/FNV/CG	GU5.3	50.5	50.7	60	950	3000	4000	10	88238



m	20W		35W		50W	
	Open	Closed	Open	Closed	Open	Closed
	8° Øm	lux			8° Øm	lux
1	0.14	4000			0.14	8000
2	0.28	1000			0.28	2000
3	0.42	444			0.42	889
4	0.56	250			0.56	500
5	0.70	160			0.70	320

m	18°		18°	
	lux	Øm	lux	lux
1	3660	0.32	2950	5920
2	915	0.63	738	1480
3	407	0.95	328	658
4	229	1.27	184	370
5	146	1.58	118	237

m	36°		36°		36°	
	lux	Øm	lux	lux	Øm	lux
1	500	0.65	450	1620	0.65	2100
2	125	1.30	113	405	1.30	525
3	56	1.95	50	180	1.95	233
4	31	2.60	28	101	2.60	131
5	20	3.25	18	65	3.25	84

m	60°	
	lux	Øm
1	1190	1.15
2	298	2.31
3	132	3.46
4	74	4.62
5	48	5.77

# Halogen lamps

## Low voltage

### Standard MR16

Watts	Volts	Product Description	Cap	Length mm	Diameter mm	Beam angle	Candela	CCT (K)	Life(h)	Pack Qty	Product Code
ø 50 mm – open dichroic mirror											
20	12	M69/BAB/STD	GU5.3	48	50	36	440	3000	3000	10	27460
35	12	M81/FMW/STD	GU5.3	48	50	36	850	3000	3000	10	27465
50	12	M58/EXN/STD	GU5.3	48	50	36	1420	3000	3000	10	27467
ø 50 mm – closed dichroic mirror											
20	12	M269/BAB/CG/STD	GU5.3	50	50	36	440	3000	3000	10	27473
35	12	M270/FRA/CG/STD	GU5.3	50	50	12	6750	3000	3000	10	27487
35	12	M281/FMW/CG/STD	GU5.3	50	50	36	850	3000	3000	10	27474
50	12	M250/EXZ/CG/STD	GU5.3	50	50	12	8550	3000	3000	10	27486
50	12	M258/EXN/CG/STD	GU5.3	50	50	36	1420	3000	3000	10	27475
50	12	M280/FNV/CG/STD	GU5.3	50	50	55	580	3000	3000	10	27476



### Precise™ Alutech™ MR16 – UV Control

Watts	Volts	Product Description	Cap	Length mm	Diameter mm	Beam angle	Candela	CCT (K)	Life(h)	Pack Qty	Product Code
ø 50 mm – closed aluminised coating											
20	12	M269/BAB/CG/AL	GU5.3	50.5	50.7	36	450	3000	3000	10	88216
35	12	M281/FMW/CG/AL	GU5.3	50.5	50.7	36	1300	3000	3000	10	88217
50	12	M258/EXN/CG/AL	GU5.3	50.5	50.7	36	1800	3000	3000	10	88215
50	12	M280/FNV/CG/AL	GU5.3	50.5	50.7	60	700	3000	3000	10	88214



### MR16 Start

Watts	Volts	Product Description	Cap	Length mm	Diameter mm	Beam angle	Candela	CCT (K)	Life(h)	Pack Qty	Product Code
ø 50 mm – open dichroic mirror											
20	12	M69/BAB/EC	GU5.3	47.6	50.5	36	500	2900	2000	20	38000
35	12	M81/FMW/EC	GU5.3	47.6	50.5	36	925	3000	2000	20	38001
50	12	M50/EXZ/EC	GU5.3	47.6	50.5	24	2700	3000	2000	20	39874
50	12	M58/EXN/EC	GU5.3	47.6	50.5	36	1500	3000	2000	20	38002
ø 50 mm – closed dichroic mirror											
20	12	M268/ESX/CG/EC	GU5.3	47.6	50.5	12	3150	2900	2000	20	38012
20	12	M269/BAB/CG/EC	GU5.3	47.6	50.5	36	450	2900	2000	20	38006
35	12	FRB/CG/EC	GU5.3	47.6	50.5	12	6750	3000	2000	20	38013
35	12	M281/FMW/CG/EC	GU5.3	47.6	50.5	36	830	3000	2000	20	38007
50	12	M249/EXT/CG/EC	GU5.3	47.6	50.5	12	8550	3000	2000	20	38014
50	12	M250/EXZ/CG/EC	GU5.3	47.6	50.5	24	2700	3000	2000	20	39611
50	12	M258/EXN/CG/EC	GU5.3	47.6	50.5	36	1350	3000	2000	20	38011
50	12	M280/FNV/CG/EC	GU5.3	47.6	50.5	55	630	3000	2000	20	39236



### MR16 IR

Watts	Volts	Product Description	Cap	Length (mm)	Diameter	Beam angle	Candela	CCT (K)	Life(h)	Pack Qty	Product Code
20	12	M270/FRA/CG IR	GU5.3	50	50,7	24	2300	3000	5000	20	45245
20	12	M281/FMW/CG IR	GU5.3	50	50,7	36	1000	3000	5000	20	45240
35	12	M250/EXZ/CG IR	GU5.3	50	50,7	24	4400	3000	5000	20	45239
35	12	M258/EXN/CG IR	GU5.3	50	50,7	36	2200	3000	5000	20	45244



## Precise™ MR11 – UV Control

Watts	Volts	Product Description	Cap	Length mm	Diameter mm	Beam angle	Candela	CCT (K)	Life (h)	Pack	Product Code
ø 35 mm – open dichroic mirror											
12	12	M64/FTA	GU4	40	35.3	8	4400	2900	2000	10	19637
20	12	M52/FTB	GU4	40	35.3	10	4400	2900	3500	10	19998
20	12	M51/FTC	GU4	40	35.3	17	2000	2900	3500	10	19630
20	12	M62/FTD	GU4	40	35.3	26	550	2900	3500	10	19626
35	12	M65/FTE	GU4	40	35.3	10	7000	2900	3500	10	19641
35	12	M66/FTF	GU4	40	35.3	21	2300	2900	3500	10	19635
35	12	M199/FTH	GU4	40	35.3	26	1300	2900	3500	10	19634
20	12	M54/FST	B15D	41	35.3	16	1760	2900	3500	10	19687
20	12	M63/FSV	B15D	41	35.3	30	600	2900	3500	10	19997



ø 35 mm – closed dichroic mirror											
12	12	M264/FTA/CG	GU4	45	35.3	8	3960	3200	2000	10	19639
20	12	M252/FTB/CG	GU4	45	35.3	10	3960	2900	3500	10	19638
20	12	M251/FTC/CG	GU4	45	35.3	17	1800	2900	3500	10	19636
20	12	M262/FTD/CG	GU4	45	35.3	26	490	2900	3500	10	19625
35	12	M265/FTE/CG	GU4	45	35.3	10	6300	3200	3500	10	19640
35	12	M266/FTF/CG	GU4	45	35.3	21	2070	2900	3500	10	19627



m	Cap: GU4 12W			Cap: GU4 20W			Cap: B15D 20W		Cap: GU4 35W		
	Open lux	8° Øm	Closed lux	Open lux	10° Øm	Closed lux	Open lux	Closed lux	Open lux	10° Øm	Closed lux
1	4400	0.14	3960	4400	0.17	3960			7000	0.17	6300
2	1100	0.28	990	1100	0.35	990			1750	0.35	1575
3	489	0.42	440	489	0.52	440			778	0.52	700
4	275	0.56	248	275	0.70	248			438	0.70	394
5	176	0.70	158	176	0.87	158			280	0.87	252

m	lux	17° Øm	lux	lux	16° Øm	lux	lux	21° Øm	lux	
1			2000	0.30	1800	1760	0.28	2300	0.37	2070
2			500	0.60	450	440	0.56	575	0.74	518
3			222	0.90	200	196	0.84	256	1.11	230
4			125	1.20	113	110	1.12	144	1.48	129
5			80	1.49	72	70	1.41	92	1.85	83

m	lux	26° Øm	lux	lux	30° Øm	lux	lux	26° Øm	lux
1			550	0.46	490	600	0.54	1300	0.46
2			138	0.92	123	150	1.07	325	0.92
3			61	1.39	54	67	1.61	144	1.39
4			34	1.85	31	38	2.14	81	1.85
5			22	2.31	20	24	2.68	52	2.31

## MR11 START

Watts	Volts	Product Description	Cap	Length mm	Diameter mm	Beam angle	Candela	CCT (K)	Life (h)	Pack	Product Code
20	12	FTD/M262/CG	GU4	45	35.3	26	490	2800	2000	10	17200
35	12	FTF/M199/CG	GU4	45	35.3	26	1150	2900	2000	10	17201

# Halogen lamps

## Low voltage

# AR 111 Reflector

GE Halogen  
Reflectors



AR 111



**Bright, white halogen light quality (up to 2950K) for decorative and architectural lighting**

- Aluminium faceted reflector for a better beam control
- Metal cap over filament to avoid direct glare effects and hot point
- UV-block to reduce bleaching effect
- Long life (3 000 hours) and 75%+ lumen maintenance to lower maintenance costs

### UV - Block

- Choice of nominal beam angles from 8° to 45°
- From 35 to 100 Watt
- 75% lumen maintenance
- 12 volts – Cap G53
- Dimmable

**The GE AR111 aluminium faceted reflector has been designed to**

- Direct light and heat forward to protect the gear (especially for electronic fixtures)
- To be used together with ConstantColor CMH™ 3000K to achieve the right lighting effect
- Use G53 cap for easy retrofit of the lamps
- Offer a slim shape to allow creative and compact design

### Applications:

- display and accent lighting
- general lighting in retail

## AR111 – UV Control



Watts	Volts	Product Description	Cap	Length mm	Diameter mm	Beam angle	Candela	CCT (K)	Lifel(h)	Pack Qty	Product Code
ø 111 mm – aluminium reflector, metal cap over filament											
35	12	AR111 35W12V SP	G53	67	111	8	11000	2800	2000	10	10774
35	12	AR111 35W12V FL	G53	67	111	24	2400	2800	2000	10	10775
50	12	AR111 50W12V SP	G53	67	111	8	17800	2850	3000	10	10766
50	12	AR111 50W12V FL	G53	67	111	24	3000	2850	3000	10	10767
75	12	AR111 75W12V SP	G53	67	111	8	23500	2900	3000	10	10768
75	12	AR111 75W12V FL	G53	67	111	24	4750	2900	3000	10	10769
75	12	AR111 75W12V WFL	G53	67	111	45	1600	2900	3000	10	10771
100	12	AR111 100W12V SP	G53	67	111	8	43000	2950	3000	10	41915
100	12	AR111 100W12V FL	G53	67	111	24	7700	2950	3000	10	41922
100	12	AR111 100W12V WFL	G53	67	111	45	2400	2950	3000	10	41923



## UV Control Capsules

All the power, quality  
and precision of halogen –  
with UV control



UV Control  
Capsules

- The ultra violet light emitted by standard halogen lamps can cause fading or bleaching of sensitive display items.
- **GE's UV Control Capsules** significantly reduce the effect of bleaching by minimising UV-B and UV-C radiation.

**GE's UV Control Capsules give maximum light output and colour quality.**

**The range includes axial filament types for use in linear miniature reflectors and uplighters, providing: Wide, smooth beam** with accurate light cut-off – perfect for uniform lighting effects.

**Maximum versatility** – common light-centres across a range of wattages let you use one light fitting design for a range of applications.

### Applications:

- retail
- display and task lighting.

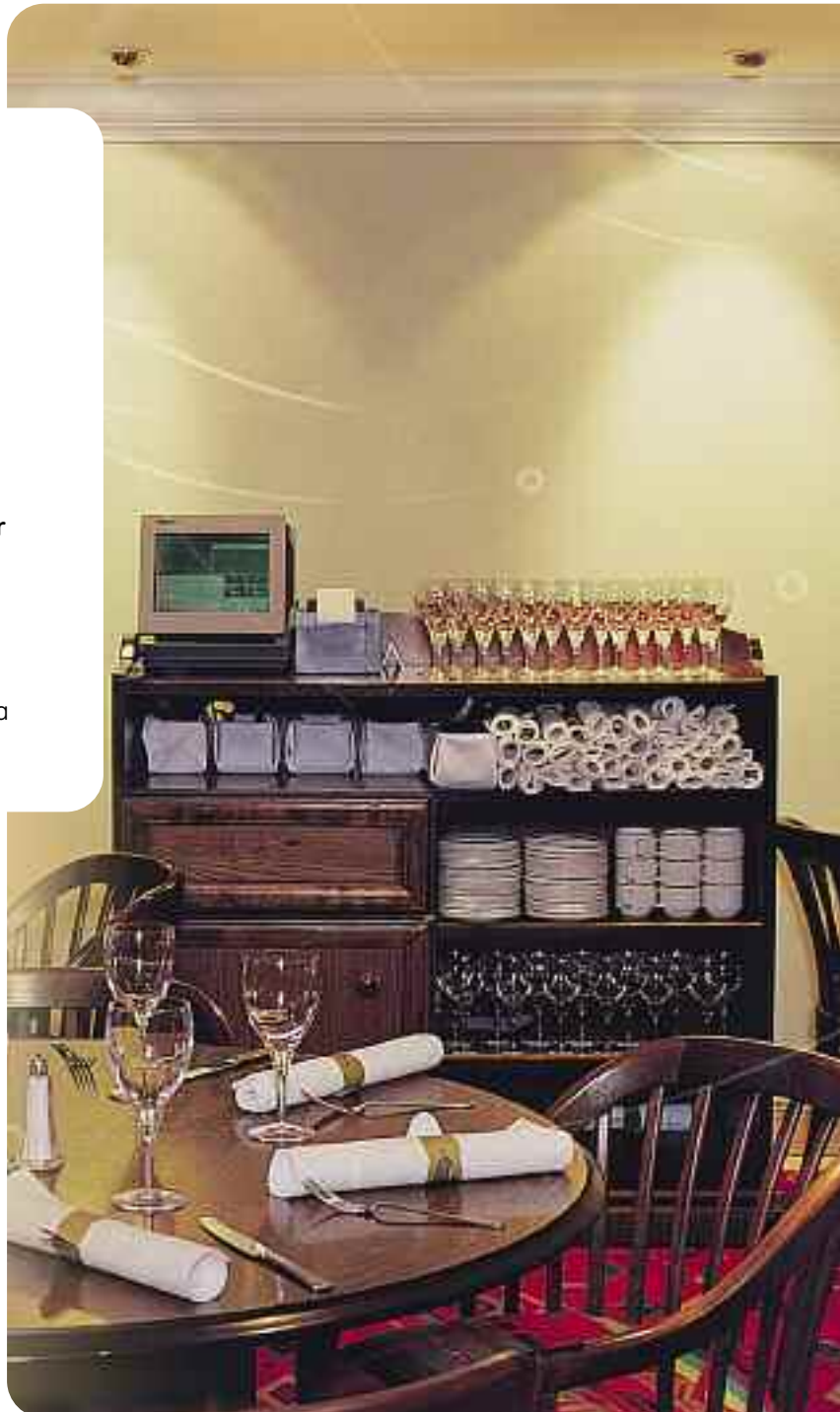

# Halogen lamps

## Low voltage

### Low Voltage single ended halogen capsules UV-Control

Watts	Volts	Product Description	Cap	Length mm	LCL	Diameter mm	Lumen	Life (h)	Pack Qty	Product Code
<b>Hard glass capsules with transversal filament</b>										
5	12	M9/H5 G4	G4	33	19.5	9	60	2000	20	42959
10	12	M11/H10 G4	G4	33	19.5	9	140	2000	20	34674
<b>Quartz glass capsules with transversal filament</b>										
10	6	M29/Q10 G4	G4	33	19.5	9	200	100	20	34720
10	6	M42/Q10 G4	G4	33	19.5	9	140	2000	20	34728
20	6	M30/ESB/Q20 G4	G4	33	19.5	9	450	100	20	34718
20	6	M34/FHE/Q20 G4	G4	33	19.5	9	350	2000	20	34719
20	12	M35/Q20 G4	G4	33	19.5	9	400	250	20	34714
20	12	M47/Q20 G4	G4	33	19.5	9	380	2000	20	34715
20	12	M312/Q20/GY6.35	GY6.35	44	30.0	11	350	2000	20	34713
35	12	M95/Q35/GY6.35	GY6.35	44	30.0	11	550	3000	20	34708
50	12	M32/Q50 GY6.35	GY6.35	44	30.0	11	930	4000	20	34702
75	12	M313/Q75/GY6.35	GY6.35	44	30.0	11	1350	2000	20	34682
100	12	M28/Q100 GY6.35	GY6.35	44	30.0	11	2200	3000	20	34676
50	24	M89/Q50/GY6.35 24V	GY6.35	44	30.0	11	750	2000	20	34684
100	24	M67/Q100 GY6.35 24V	GY6.35	44	30.0	11	2000	2000	20	34663
<b>Quartz glass capsules with axial filament</b>										
20	12	M76/Q20/GY6.35	GY6.35	44	30.0	11	300	4000	20	34712
35	12	M75/Q35/GY6.35	GY6.35	44	30.0	11	600	4000	20	34710
50	12	M74/Q50/GY6.35	GY6.35	44	30.0	11	900	4000	20	34703
75	12	M73/Q75/GY6.35	GY6.35	44	30.0	11	1350	4000	20	34683
100	12	M180/Q100/GY6.35	GY6.35	44	30.0	11	2150	4000	20	34664
<b>Low pressure halogen capsules with axial filament</b>										
10	12	Q10T2,5/12V G4	G4	33	22	9	140	2000	20	35705
20	12	Q20T2,5/12V G4	G4	33	22	9	320	2000	20	35710
20	12	Q20T3/12V GY6.35	GY6.35	44	30	11	300	2000	20	35696
35	12	Q35T3/12V GY6.35	GY6.35	44	30	11	600	2000	20	35699
50	12	Q50T3/12V GY6.35	GY6.35	44	30	11	950	2000	20	35700
75	12	Q75T3/12V GY6.35	GY6.35	44	30	11	1350	2000	20	35701

### Low Voltage single ended halogen capsules START range

Watts	Volts	Product Description	Cap	Length mm	LCL	Diameter mm	Lumen	Life (h)	Pack Qty	Product Code
<b>Quartz glass capsules with transversal filament</b>										
10	12	M11/Q10/G4 ST	G4	33	22	9	100	1000	20	12708
20	12	M47/Q20/G4 ST	G4	33	22	9	250	1000	20	12711
35	12	M95/Q35/GY6.35 ST	GY6.35	44	30	11	480	1000	20	12712
50	12	M32/Q50/GY6.35 ST	GY6.35	44	30	11	800	1000	20	12713
100	12	Q100/GY6.35 ST	GY6.35	44	30	11	1950	1000	20	12718



## Mains voltage halogen reflector



A lamp with an aluminium coated reflector directs most of its heat to the front. With its distinct MR 16 look, the cool beam and aluminium lamps are the most compact lamps of their kind available. Because the lamp can be connected directly to the mains supply, the use of bulky and costly transformers is not necessary and offers benefits for both consumers as well as luminaire manufacturers.

- Small size
- High efficiency
- Excellent white light
- Up to 2000 hours life

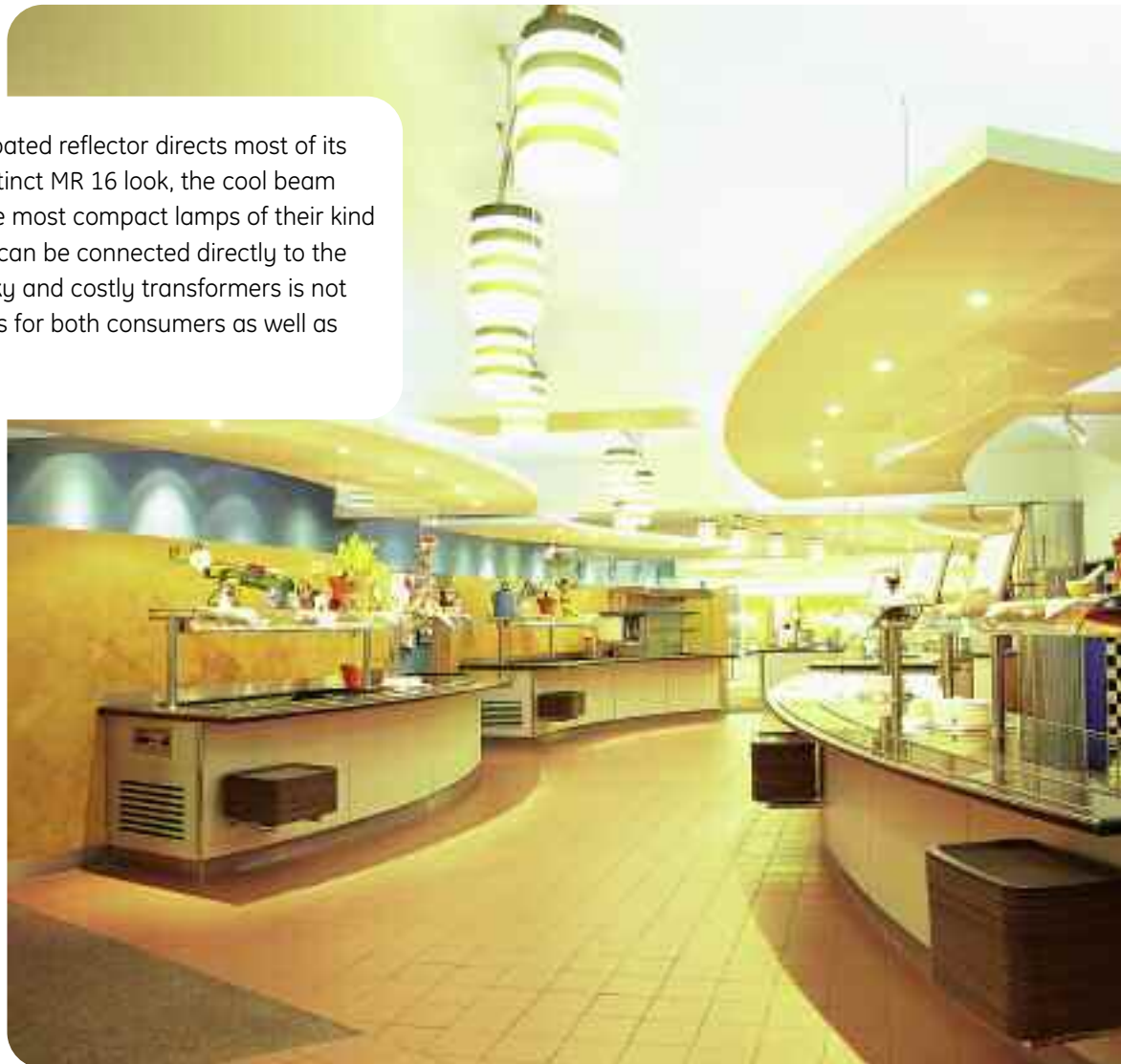

### Applications:

- retail display
- conference room
- reception areas

# Halogen lamps

## Mains voltage

### MR16 Mains Tech



Watts	Volts	Product Description	Cap	Length mm	Diameter mm	Beam angle	Colour	Candela	CCT (K)	Life (h)	Pack Qty	Product Code
ø 50 mm – closed aluminium coated reflector												
50	230	Q50MR16/230/25°	GU10	57.5	51	25		950	2650	2000	1/50	40402
50	240	Q50MR16/240/25°	GU10	57.5	51	25		950	2650	2000	1/50	40404
50	230	Q50MR16/230/36°	GU10	57.5	51	36		600	2650	2000	1/50	40403
50	240	Q50MR16/240/36°	GU10	57.5	51	36		600	2650	2000	1/50	40405

### MR20 Mains Tech



ø 64 mm – closed aluminium coated reflector												
75	240	Q75MR16/240/25°	GU10	64	64	25		2500	2900	2000	1/10	19624

### MR16 Mains Start



Watts	Volts	Product Description	Cap	Length mm	Diameter mm	Beam angle	Colour	Candela	CCT (K)	Life (h)	Pack Qty	Product Code
ø 50 mm – closed aluminium coated reflector												
20	230	Q20MR16/230/FL	GU10	55	51	36		200	2700	1500	10	10898
35	230	Q35MR16/230/FL	GU10	55	51	36		400	2700	1500	10	10896
50	230	Q50MR16/230/FL	GU10	55	51	36		600	2700	1500	10	92729
20	240	Q20MR16/240/FL	GU10	55	51	36		200	2700	1500	10	10859
35	240	Q35MR16/240/FL	GU10	55	51	36		400	2700	1500	10	10857
50	240	Q50MR16/240/FL	GU10	55	51	36		600	2700	1500	10	92730

### MR16 Mains Dichroic Start

ø 50 mm – closed dichroic reflector												
50	230	Q50MR16/230V/GZ10	GZ10	57.5	51	36		600	2650	1500	1/10	18157

### MR16 Mains Start – Coloured



Watts	Volts	Product Description	Cap	Length mm	Diameter mm	Beam angle	Colour	CCT (K)	Life (h)	Pack Qty	Product Code	
ø 50 mm – Closed												
50	240	Q50MR16/240/FL START	GU10	55	51	36	RED		1500	10	12988	
50	240	Q50MR16/240/FL START	GU10	55	51	36	BLUE		1500	10	12995	
50	240	Q50MR16/240/FL START	GU10	55	51	36	GREEN		1500	10	12998	
50	240	Q50MR16/240/FL START	GU10	55	51	36	YELLOW		1500	10	13003	



## G9 capsule

Suitable for a wide variety of applications in display, accent and general where halogen light quality is essential with the ease of mains voltage where no transformer is required.



Short G9

### G9 capsule has been designed to

- offer a miniature halogen solution to allow creative and compact design of fittings
- be fully compatible with ConstantColor™ CMH 3000 K lamps
- use G9 Cap for easy retrofit of the lamps used in open fixtures
- meet IEC standards IEC60357, IEC60432-2 and IEC60061-1 for performance, safety and base compliance.
- operate on mains voltage, no transformer required.

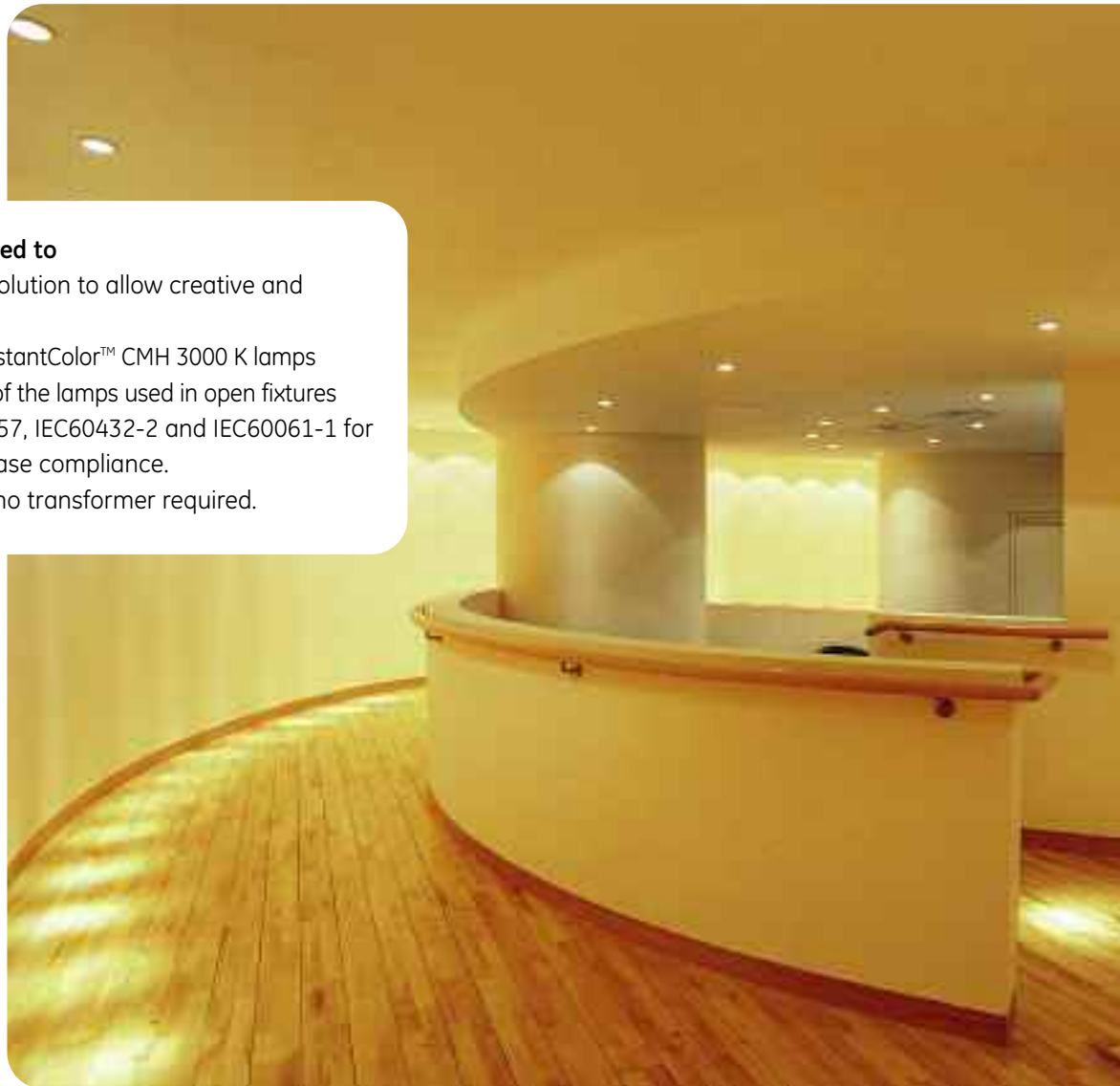

### Applications:

- display
- accent
- general lighting

# Halogen lamps

## Mains voltage

### Single ended mains voltage capsule – Tech Range

Watts	Volts	Product Description	Cap	Length mm	Diameter mm	Lumen	CCT (K)	Life (h)	Pack Qty	Energy Efficiency Class	Product Code
Halo Capsule Short G9 clear – UV Control											
25	230	SHORTG9 25W CL 230V	G9	43	13	260	2800	1500	10	D	45692
25	240	SHORTG9 25W CL 240V	G9	43	13	260	2800	1500	10	D	26318
40	230	SHORTG9 40W CL 230V	G9	43	13	490	2800	2000	10	D	22504
40	240	SHORTG9 40W CL 240V	G9	43	13	490	2800	2000	10	D	22498
60	230	SHORTG9 60W CL 230V	G9	43	13	820	2800	2000	10	D	22513
60	240	SHORTG9 60W CL 240V	G9	43	13	820	2800	2000	10	D	22508
75	230	SHORTG9 75W CL 230V	G9	43	13	1100	2800	2000	10	D	23517
75	240	SHORTG9 75W CL 240V	G9	43	13	1100	2800	2000	10	D	23518
frosted											
25	230	SHORTG9 25W FR 230V	G9	43	13	260	2800	1500	10	D	45693
25	240	SHORTG9 25W FR 240V	G9	43	13	260	2800	1500	10	D	45693
40	230	SHORTG9 40W FR 230V	G9	43	13	490	2800	2000	10	D	22507
40	240	SHORTG9 40W FR 240V	G9	43	13	490	2800	2000	10	D	22501
60	230	SHORTG9 60W FR 230V	G9	43	13	820	2800	2000	10	D	22515
60	240	SHORTG9 60W FR 240V	G9	43	13	820	2800	2000	10	D	22510
75	230	SHORTG9 75W FR 230V	G9	43	13	1100	2800	2000	10	D	23521
75	240	SHORTG9 75W FR 240V	G9	43	13	1100	2800	2000	10	D	23532



### Mains voltage double-ended halogen lamps

Watts	Volts	Product Description	Cap	Length mm	Diameter mm	Lumen	CCT (K)	Life (h)	Pack Qty	Energy Efficiency Class	Product Code
Start clear											
200	230	K11/230V ST	R7s	117.6	8	2A	2850	1500	10	E	93471
300	230	K9/230V ST	R7s	117.6	8	2A	4600	1500	10	E	93472
500	230	K1/230V ST	R7s	117.6	8	4A	9000	1500	10	E	93473
200	240	K11/240V ST	R7s	117.6	8	2A	2850	1500	10	E	93475
300	240	K9/240V ST	R7s	117.6	8	2A	4600	1500	10	E	93476
500	240	K1/240V ST	R7s	117.6	8	4A	9000	1500	10	E	93477
Standard clear											
100	120	K14/Q100 120V/CL	R7s	78.3	8	-	1500	3000	10	D	91746
150	120	K12/Q150 120V/CL	R7s	78.3	8	-	2300	3000	10	E	91747
100	230	K14/Q100 T2.5/CL	R7s	78.3	8	-	1600	2000	10	D	91427
150	230	K12/Q150 T2.5/CL	R7s	78.3	8	-	2600	2000	10	D	91428
200	230	K27/Q150 T2.5/CL	R7s	78.3	8	-	3400	2000	10	D	91430
250	230	K15/Q250 T2.5/CL	R7s	78.3	8	-	4000	2000	10	E	91431
100	240	K14/Q100 T2.5/CL	R7s	78.3	8	-	1600	2000	10	D	91506
150	240	K12/Q150 T2.5/CL	R7s	78.3	8	-	2600	2000	10	D	91507
200	240	K27/Q150 T2.5/CL	R7s	78.3	8	-	3400	2000	10	D	91508
250	240	K15/Q250 T2.5/CL	R7s	78.3	8	-	4000	2000	10	E	91509
150	120	K28/Q150 120V/CL	R7s	117.6	8	2A	2300	2000	10	E	91748
200	120	K11/Q200 120V/CL	R7s	117.6	8	4A	3300	2000	10	D	91749
300	120	K9/Q300 120V/CL	R7s	117.6	8	4A	6200	2000	10	D	91750
500	120	K1/Q500 120V/CL	R7s	117.6	8	6.3A	11000	2000	10	C	29161
1000	120	K4/Q1000 120V/CL	R7s	189.1	10	-	22000	2000	10	D	29177
100	230	K41/Q100 CL	R7s	117.6	8	2A	1050	1500	10	F	91432
150	230	K28/Q150 T2.5/CL	R7s	117.6	8	2A	2100	2000	10	E	91433
200	230	K11/Q200 T2.5/CL	R7s	117.6	8	2A	3100	2000	10	E	91434
250	230	K32/Q250 T2.5/CL	R7s	117.6	8	2A	4000	2000	10	E	91435
300	230	K9/Q300 T2.5/CL	R7s	117.6	8	2A	5100	2000	10	E	91436
500	230	K1/Q500 T2.5/CL	R7s	117.6	8	4A	9800	2000	10	D	29165
750	230	K3/Q750 T3/CL	R7s	189.1	10	6.3A	15000	2000	10	D	29173
1000	230	K4/Q1000 T3/CL	R7s	189.1	10	6.3A	21000	2000	10	D	29180
1000	230	K10/1000 T3/CL	R7s	254.1	10	6.3A	21000	2000	6	D	43711
1500	230	K5/Q1500 T3/CL	R7s	254.1	10	10A	32000	1000	10	D	29184
2000	230	K6/Q2000 T3/CL	Fa4	334.4	10	10A	44000	2000	10	D	29190
2000	230	K8/Q2000 T3/CL	R7s	330.8	10	10A	44000	1000	10	D	30886
150	240	K28/Q150 T2.5/CL	R7s	117.6	8	2A	2100	2000	10	E	91511
200	240	K11/Q200 T2.5/CL	R7s	117.6	8	2A	3100	2000	10	E	91512
250	240	K32/Q250 T2.5/CL	R7s	117.6	8	2A	4000	2000	10	E	91513
300	240	K9/Q300 T2.5/CL	R7s	117.6	8	2A	5100	2000	10	E	91514
500	240	K1/Q500 T2.5/CL	R7s	117.6	8	4A	9700	2000	10	D	29168
750	240	K3/Q750 T3/CL	R7s	189.1	10	6.3A	15000	2000	10	D	29176
1000	240	K4/Q1000 T3/CL	R7s	189.1	10	6.3A	21000	2000	10	D	29181
1000	240	K10/1000 T3/CL	R7s	254.1	10	6.3A	21000	2000	6	D	43712
1500	240	K5/Q1500 T3/CL	R7s	254.1	10	10A	32000	1000	10	D	29187
2000	240	K8/Q2000 T3/CL	R7s	330.8	10	10A	44000	1000	10	D	30877

78 mm lamps are internally fused, and universal operating position. Other lamps operating position horizontal  $\pm 4^\circ$ .

#### Halogen IR™

225	230	K9/Q225 T3/230V HIR	R7s	117.6	10	2A	5000	2000	10	C	91515
375	230	K1/Q375 T3/230V HIR	R7s	117.6	10	2A	9400	2000	10	C	31598

Operating position horizontal  $\pm 4^\circ$ .

# Halogen lamps

## Mains voltage

### Halogen PAR lamps

#### PAR 16



Watts	Volts	Product Description	Cap	Length mm	Diameter mm	Beam angle	Candela	CCT (K)	Life(h)	Pack Qty	Product Code
Flood											
40	230	40PAR16/230/FL	E14	79	50	36	450	2900	2000	10	27826
40	240	40PAR16/240/FL	E14	79	50	36	450	2900	2000	10	27845

#### PAR 20



Watts	Volts	Product Description	Cap	Length mm	Diameter mm	Beam angle	Candela	CCT (K)	Life(h)	Pack Qty	Product Code
Spot											
50	230	50PAR20/230/SP	E27	91	64.5	10	3000	2750	2000	1/15	40363
50	240	50PAR20/240/SP	E27	91	64.5	10	3000	2750	2000	1/15	40364
Flood											
50	230	50PAR20/230/FL	E27	91	64.5	30	1000	2750	2000	1/15	40362
50	240	50PAR20/240/FL	E27	91	64.5	30	1000	2750	2000	1/15	40365



#### PAR 25



Watts	Volts	Product Description	Cap	Length mm	Diameter mm	Beam angle	Candela	CCT (K)	Life(h)	Pack Qty	Product Code
Flood											
75	230	75PAR25/230/FL	E27	108	81	25	1300	2900	3000	15	91775
75	240	75PAR25/240/FL	E27	108	81	25	1300	2900	3000	15	92165

#### PAR 30

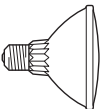

Watts	Volts	Product Description	Cap	Length mm	Diameter mm	Beam angle	Candela	CCT (K)	Life(h)	Pack Qty	Product Code
Spot											
75	230	75PAR30/230/SP	E27	90.5	97	10	6900	2900	2000	15	40366
75	240	75PAR30/240/SP	E27	90.5	97	10	6900	2900	2000	15	40367
Flood											
75	230	75PAR30/230/FL	E27	90.5	97	30	2200	2900	2000	15	40349
100	230	100PAR30/230/FL	E27	90.5	97	30	3500	2900	3000	15	32484
75	240	75PAR30/240/FL	E27	90.5	97	30	2200	2900	2000	15	40361
100	240	100PAR30/240/FL	E27	90.5	97	30	3500	2900	3000	15	32482

#### PAR 16 – PAR 20 – PAR 25 – PAR 30

m	40W				50W				75W				100W			
	PAR 16		PAR 16 Start		PAR 20 Spot 10°		PAR 25 Spot 10°		PAR 25 Spot 10°		PAR 30 Spot 10°		PAR 30 Spot 10°			
	Øm	lux	Øm	lux	Øm	lux	Øm	lux	Øm	lux	Øm	lux	Øm	lux		
1					0.17	3000	0.17	4000	0.17	5500	0.17	6900	0.17	10000		
2					0.35	750	0.35	1000	0.35	1375	0.35	1725	0.35	2500		
3					0.52	333	0.52	444	0.52	611	0.52	767	0.52	1111		
4					0.70	188	0.70	250	0.70	344	0.70	431	0.70	625		
5					0.87	120	0.87	160	0.87	220	0.87	276	0.87	400		
m	Flood 25°		Flood 36°		Flood 30°		Flood 25°		Flood 25°		Flood 30°		Flood 30°			
	Øm	lux	Øm	lux	Øm	lux	Øm	lux	Øm	lux	Øm	lux	Øm	lux		
1	0.44	950	0.65	800	0.54	1000	0.44	1100	0.44	1300	0.54	2200	0.54	3500		
2	0.89	238	1.30	200	1.07	250	0.89	275	0.89	325	1.07	550	1.07	875		
3	1.33	106	1.95	89	1.61	111	1.33	122	1.33	144	1.61	244	1.61	389		
4	1.77	59	2.60	50	2.14	63	1.77	69	1.77	81	2.14	138	2.14	219		
5	2.22	38	3.25	32	2.68	40	2.22	44	2.22	52	2.68	88	2.68	140		



## HaloReflector, HaloCandle and Halolightbulb

HaloReflectors provide up to 20% more light



HaloReflectors

HaloCandle – Chandeliers will sparkle even more with halogen light



HaloCandle

HaloGLS – Upgrade the light quality with a traditional light bulb shape



HaloGLS

**New GE halogen lamps for the perfect atmosphere for home applications.**

### HaloReflector

- Flicker free light reduces eye strain
- R80, R63 R50 reflector bulb for all purposes
- 40W, 60W, 100W

### HaloCandle

- Candle and twisted candle shapes enriches your home
- Clear candle to maximise light, frosted candle to reduce glare
- 40W, 60W

### HaloGLS

- Save energy, get more light with the same power
- More compact (50 mm) standard light bulb shape
- 40W, 60W

New halogen technology opens new dimension for home and retail lighting. On average creates 20% more light than a standard incandescent light bulb. A 60W HaloGLS is equivalent to a 72W incandescent lamp. Dimming makes it even more economical. A range of familiar shapes have been developed to be suitable for available fittings. In addition to this you can enjoy products of the Halogen family for 2000 hours in your home, twice as long than before.



# Halogen lamps

## Mains voltage

### HaloGlobe™

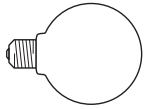

Watts	Volts	Product Description	Cap	Length mm	Diameter mm	Lumen	CCT (K)	Life (h)	Pack Qty	Energy Efficiency Class	Product Code
white											
60	230	HaloG95/60W/W 230V E27	E27	138.5	95	700	2850	2000	10	E	92534
100	230	HaloG95/100W/W 230V E27	E27	138.5	95	1350	2850	2000	10	E	92535
150	230	HaloG95/150W/W 230V E27	E27	138.5	95	2100	2850	2000	10	E	92536

Operating position: Universal.

### HaloGLS

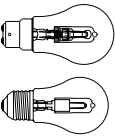

Watts	Volts	Product Description	Cap	Length mm	Lumen	CCT(K)	Life (h)	Pack Qty	Energy Efficiency Class	Product Code
clear - UV control										
40	240	Halo A/Cl/40W/B22 240V	B22	108.5	490	2800	1500	10	D	21398
40	230	Halo A/Cl/40W/E27 230V	E27	50	490	2800	1500	10	D	21402
60	240	Halo A/Cl/60W/B22 240V	B22	108.5	820	2800	2000	10	D	21395
60	240	Halo A/Cl/60W/E27 240V	E27	110	820	2800	2000	10	D	21385
60	230	Halo A/Cl/60W/E27 230V	E27	110	820	2800	2000	10	D	21400
frosted - UV control										
40	240	Halo A/Fr/40W/B22 240V	B22	108.5	490	2800	1500	10	D	21399
40	230	Halo A/Fr/40W/E27 230V	E27	110	490	2800	1500	10	D	21403
60	240	Halo A/Fr/60W/E27 240V	E27	110	820	2800	2000	10	D	21386
60	240	Halo A/Fr/60W/B22 240V	B22	108.5	820	2800	2000	10	D	21397
60	230	Halo A/Fr/60W/E27 230V	E27	110	820	2800	2000	10	D	21401

### HaloCandle

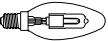

clear - UV control										
40	230	HaloC/Cl/40W/E14 230V	E14	104	490	2800	1500	10	D	43321
40	240	HaloC/Cl/40W/E14 240V	E14	104	490	2800	1500	10	D	21499
40	230	HaloC/Cl/40W/B22 240V	B22	97	490	2800	2000	10	D	43324
60	230	HaloC/Cl/60W/E 14 230V	E14	104	820	2800	2000	10	D	43323
60	240	HaloC/Cl/60W/B22 240V	B22	97	820	2800	2000	10	D	43326
60	240	HaloC/Cl/60W/E 14 240V	E14	104	820	2800	2000	10	D	21505
frosted - UV control										
40	230	HaloC/Fr/40W/E14 230V	E14	104	490	2800	1500	10	D	43327
40	240	HaloC/Fr/40W/B22 240V	B22	97	490	2800	2000	10	D	43332
40	240	HaloC/Fr/40W/E14 240V	E14	104	490	2800	1500	10	D	22760
60	230	HaloC/Fr/60W/E14 230V	E14	104	820	2800	2000	10	D	43329
60	240	HaloC/Fr/60W/B22 240V	B22	97	820	2800	2000	10	D	43335
60	240	HaloC/Fr/60W/E14 240V	E14	104	820	2800	2000	10	D	22783

### Twisted Candle



clear - UV control										
40	230	HaloC/TWCL/40W/E14 230V	E14	104	490	2800	1500	10	D	21490
40	240	HaloC/TWCL/40W/E14 240V	E14	104	490	2800	1500	10	D	22779
60	230	HaloC/TWCL/60W/E14 230V	E14	104	820	2800	2000	10	D	22781
60	240	HaloC/TWCL/60W/E14 240V	E14	104	820	2800	2000	10	D	21506
Frosted - UV control										
40	230	HaloC/TWFR/40W/E14 230V	E14	104	490	2800	1500	10	D	21495
40	240	HaloC/TWFR/40W/E14 240V	E14	104	490	2800	1500	10	D	22780
60	230	HaloC/TWFR/60W/E14 230V	E14	104	820	2800	2000	10	D	22782
60	240	HaloC/TWFR/60W/E14 240V	E14	104	820	2800	2000	10	D	22775

### HaloSpherical

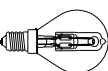

clear - UV control										
25	230	25HALOSPH/CL G9B	E14	78.5	250	2800	1500	10	D	44694
40	230	40HALOSPH/CL G9B	E14	78.5	470	2800	2000	10	D	44720
60	230	60HALOSPH/CL G9B	E14	78.5	790	2800	2000	10	D	44722
25	230	25HALOSPH/FR G9B	E14	78.5	250	2800	1500	10	D	44741
40	230	40HALOSPH/FR G9B	E14	78.5	470	2800	2000	10	D	44740
60	230	60HALOSPH/FR G9B	E14	78.5	790	2800	2000	10	D	44728



### HaloReflector

Watts	Volts	Product Description	Cap	Length mm	Candela	CCT(K)	Life (h)	Pack Qty	Energy Efficiency Class	Product Code
Satin- UV control										
40	230	HAL 40R50/E14 230V	E14	84	290	2800	2000	10	NA	23503
40	240	HAL 40R50/E14 240V	E14	84	290	2800	2000	10	NA	43266
60	240	HAL 60R63/E27 230V	E27	103	640	2800	2000	10	NA	23504
60	240	HAL 60R63/E27 240V	E27	103	640	2800	2000	10	NA	43267
60	230	HAL 60R80/E27 230V	E27	113	280	2800	2000	10	NA	23505
60	240	HAL 60R80/E27 240V	E27	113	280	2800	2000	10	NA	45442
100	230	HAL 100R80/E27 230V	E27	113	540	2800	1500	10	NA	23506
100	240	HAL 100R80/E27 240V	E27	113	540	2800	1500	10	NA	45441

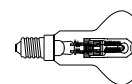

### HaloKrypton

Watts	Volts	Product Description	Cap	Length mm	Lumen	Life (h)	Pack Qty	Energy Efficiency Class	Product Code	
clear										
40	230V	40HALOKRYP/E27 230V	E27	490	2800	2000	10	D	44683	
60	230V	60HALOKRYP/E27 230V	E27	820	2800	2000	10	D	44670	
75	230V	75HALOKRYP/E27 230V	E27	1100	2800	2000	10	D	44666	
40	240V	40HALOKRYP/B22 240V	B22	490	2800	2000	10	D	44649	
60	240V	60HALOKRYP/B22 240V	B22	820	2800	2000	10	D	44710	
75	240V	75HALOKRYP/B22 240V	B22	1100	2800	2000	10	D	44709	



### HaloBTT™

Watts	Volts	Product Description	Cap	Length mm	Diameter mm	Lumen	Life (h)	Pack Qty	Energy Efficiency Class	Product Code
clear										
60	230	HaloBTT/60W/CL 230V E27	E27	120	47	820	2000	10	D	90779
100	230	HaloBTT/100W/CL 230V E27	E27	120	47	1550	2000	10	D	90780
150	230	HaloBTT/150W/CL 230V E27	E27	120	47	2600	2000	10	D	90781
60	240	HaloBTT/60W/CL 230V E27	E27	120	47	820	2000	10	D	90782
100	240	HaloBTT/100W/CL 230V E27	E27	120	47	1550	2000	10	D	90783
60	240	HaloBTT/60W/CL 230V B22	B22	120	47	820	2000	10	D	90784
100	240	HaloBTT/100W/CL 230V B22	B22	120	47	1550	2000	10	D	90785

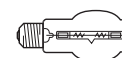

white

60	230	HaloBTT/60W/W 230V E27	E27	120	47	700	2000	10	E	90299
100	230	HaloBTT/100W/W 230V E27	E27	120	47	1350	2000	10	E	90308

Operating position: Universal.

### HaloTubular

Watts	Volts	Product Description	Cap	Length mm	Lumen	CCT(K)	Life (h)	Pack Qty	Energy Efficiency Class	Product Code
clear										
40	230	40HaloTub G9B	E14	84.5	2800	2000	2000	50	E	43290
60	230	60HaloTub G9B	E14	84.5	2800	2000	2000	50	E	43292
60	240	60HaloTub G9B	E14	84.5	2800	2000	2000	50	E	43298
100	230	J89 TUBHAL	E14	74	1350	2800	1500	50	E	93700
150	230	J90 TUBHAL	E14	74	2150	2800	1500	50	E	93701
250	230	J92 TUBHAL	E14	74	3850	2800	1500	50	E	93702



### HaloT38

Watts	Volts	Product Description	Cap	Length mm	Lumen	Life (h)	Pack Qty	Energy Efficiency Class	Product Code	
clear										
500	230	Halo T38/500W/E40/230	E40	215	9500	2000	10	D	32106	
1000	230	Halo T38/1000W/E40/230	E40	280	21000	2000	10	D	32108	
500	240	Halo T38/500W/E40/240	E40	215	9500	2000	10	D	32107	
1000	240	Halo T38/1000W/E40/240	E40	280	21000	2000	10	D	32109	



Operating position: Horizontal ±4°.

# Halogen lamps

Halogen lamps provide a compact, high output light source popular for accent, display and general lighting applications in a wide variety of commercial, industrial and residential environments.

## Choosing the right lamp

To help you achieve the most effective spread and level of illumination for your particular application, use the performance cones shown in this catalogue.

## Assessing performance cones

Performance cones show the area, strength and distribution of light produced by each lamp. This varies according to the level of illuminance produced by the lamp (lux), the height of the lamp above the object being illuminated, and the beam angle of the lamp selected.

## Selecting power and beam

Comparing performance cones lets you select the correct lamp for your needs. For example, GE's most commonly used mirror lamp, the 50W EXZ Precise™ MR16 ConstantColor™ with a beam angle of 25°, would produce 700 lux at 2 metres high with a beam diameter of 0.9 metres.

If, however, you wanted a smaller beam diameter of say 0.4 metres, the 20W spot beam ESX with its narrower 12° beam angle would be more effective, producing 838 lux. This would provide 15% extra luminance with a 60% reduction in energy consumption.

## Selecting beam angles

GE halogen lamps are offered in a range of beam angles from 8° to 60°. Choose small beam angles to highlight single features with a tight focus, wide beam angles to provide a wash of ambient lighting achieve a variety of effects with intermediate beams.

Figure 1

### Choosing the right power and beam

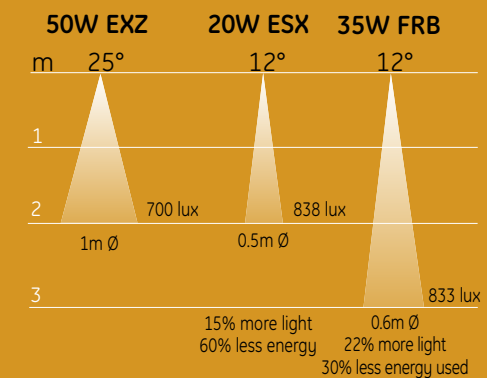
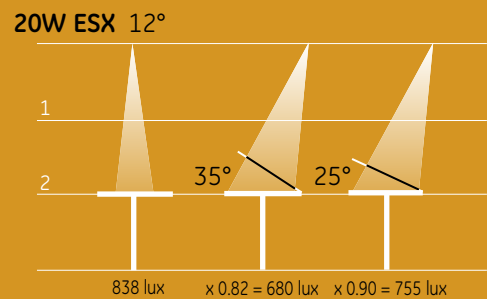
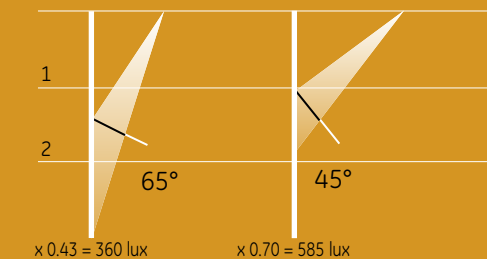

Figure 2

### Choosing beam angles



### 20W ESX



### 3 x 50W EXZ lamps

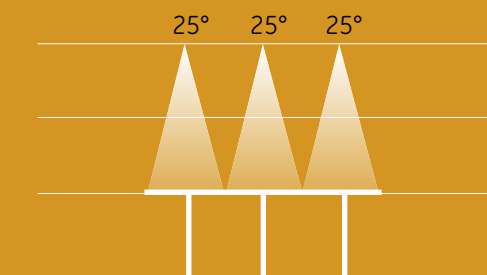

### Uniform performance

The performance cones can also provide a quick guide for achieving uniformity of illuminance on a horizontal plane.



## General information

### Select UV control

Tungsten halogen lamps emit some ultra violet rays similar to sunlight. Although the level of ultra violet emitted by halogen lamps is far lower – for example 8 hours in an office lit by halogen is equivalent to 10 minutes' sun eliminating these emissions is a sensible precaution. Choosing UV control halogen lamps effectively eliminates UV-C and greatly reduces UV-B radiation.

### How to achieve maximum lamp performance

Most instances of early failure of halogen lamps are caused by incorrect installation. The risk of early failure will be reduced if you observe the following points:

- **Damage such** as bent pins and cracks in the base caused by rough handling during installation.
- **Poor electrical contact** between pins and lampholder which can lead to arcing. This is usually a result of insufficient insertion of the pins into the lamp holder.
- **Finger grease** on the quartz bulb which creates local hot spots and can lead to disintegration of the glass. Note this problem is avoided with sealed mirror reflectors or lamps with an integral outer glass envelope as the halogen bulb is protected from handling.
- **Over voltage** – running a lamp at higher than rated voltage for prolonged periods can substantially reduce life. For example, a 5% increase in rated lamp voltage can lead to a 50% reduction in lamp life. If problems occur the voltage should be checked at the lamp base and the rating of the transformer should be checked against the lamp load applied.
- **Overheating** is usually caused by insufficient ventilation or cooling of the lamp and can be the result of poorly designed installation. Overheating can be also caused by overvoltage, insertion of a dichroic reflector in closed fittings or usage of a higher wattage lamp than the fixture allows.
- **Open lamps** should only be used within a shield, except self-shielded tungsten halogen lamps.

### Atmospheric factors

In harsh atmospheric conditions we would recommend ConstantColor™ which has a much more resilient coating plus the added advantage of 6000 hours. Humidity does not normally present a problem with dichroic lamps, however early lamp failure can occur in areas of high humidity such as in kitchens, bathrooms and swimming pools. In these applications, fittings should be chosen with a moisture resistance or IP rating, appropriate to the environmental conditions in which they will be used.



## Fluorescent lamps

GE offers the benefits of nearly 60 years experience in the design and manufacture of fluorescent lamps.

Our comprehensive range of lamps continues to set new standards in light output, quality and efficiency and is available in a wide choice of lengths, wattages and colours.

Choose GE fluorescents for saving energy, extra long lamp life, excellent lumen maintenance, improved colour performance and higher light output.



## Content

Fluorescent selection guide	54
T5 Watt-Miser™ High Efficiency	58
T5 Watt-Miser™ High Output	58
LongLast Starcoat™ T5 High Efficiency	60
LongLast Starcoat™ T5 High Output	60
T5 Electronic Ballast	62
T5 Ultrastart™ Ballast	62
T5 Miniature	62
T5 Polylux	62
T5 Specfill	62
T5 Blacklight	62
T8 Polylux XLr™	65
T8 Electronic Ballast	65
T8 Polylux XLr™ LongLast	66
T8 Watt-Miser™	67
T8 Standard Halophosphate	68
T8 Cov-R-Guard™ Polylux XLr™	70
T8 Special Colours	70
T12 Polylux	71
T12 Rapid Start	71
T12 Standard Halophosphate	71
T12 Blacklight Blue	72
T12 HO and VHO	72
T12 Slimline™	72
T17 Power Groove™ Rapid Start	72
Circline™	72
Mod-U-Line™	72
Starters	72
General information	73

## Fluorescent selection guide

### Lumen value table (Initial lumens at 35C°)

Wattage length mm Lamp	4 150	6 225	8 300	13 525	14 549	21 849	24 549	28 1149	35 1449	39 849	49 1449	54 1149	80 1449	15 450	18 600	30 900	36-1M 970	36 1200	38 1050	58 1500	70 1800																
	T5 16 mm Ø												T8 25 mm Ø																								
Watt-Miser Lamps	<b>830 Watt-Miser</b>												1350	2100	2000	2900	3650	3500	4900	5000	7000																
	<b>835 Watt-Miser</b>												1350	2100	2000	2900	3650	3500	4900	5000	7000																
	<b>840 Watt-Miser</b>												1350	2100	2000	2900	3650	3500	4900	5000	7000																
	<b>865 Watt-Miser</b>												1250	1950	1900	2700	3400	3330	4650	4750	6650																
Starcoat	<b>827 Starcoat™</b>												1350	2100	2000	2900	3650	3500	4900	5000	7000																
T5 Lamps	<b>830 Starcoat™</b>												1350	2100	2000	2900	3650	3500	4900	5000	7000																
	<b>835 Starcoat™</b>												1350	2100	2000	2900	3650	3500	4900	5000	7000																
	<b>840 Starcoat™</b>												1350	2100	2000	2900	3650	3500	4900	5000	7000																
	<b>865 Starcoat™</b>												1250	1950	1900	2700	3400	3330	4650	4750	6650																
Triphosphor	<b>827 Polyflux XLr™</b>																		1000	1350	2450				3350				5200								
Polyflux XLr	<b>830 Polyflux XLr™</b>																		1000	1350	2450	3100	3350				5200	6300									
Lamps	<b>835 Polyflux XLr™</b>																								1350				3350				5200	6300			
	<b>840 Polyflux XLr™</b>																		1000	1350	2450	3100	3350				5200	6300									
	<b>860 Polyflux XLr™</b>																								1300				3250				5000				
Cov-R-Guard	<b>830 Polyflux XLr™</b>																											1300				3250				5050	6100
Shielded	<b>835 Polyflux XLr™</b>																											1300				3250				5050	6100
Fluorescent	<b>840 Polyflux XLr™</b>																											1300				3250				5050	6100
	<b>860 Polyflux XLr™</b>																											1250				3200					
Standard	<b>29 Warm White</b>																								395				850								
Halophosphate	<b>35 White</b>												130	260	395	850							850	1150	2250				2850				4600	5550			
	<b>25 Natural</b>																																				
	<b>Universal White</b>																																				
	<b>33 Cool white</b>												150	260	380	800							775	1100	1900	2250	2600				4100						
	<b>54 Daylight</b>																		850	1150	2175	2600	2850				4600	5450									
																			750	950	1850	1900	2350				3750										

### Product Colour Performance Characteristics

Type	CIE Group	Ra Index Description	Ra Index	CCT K	GE ref	Avg. lm/W	
Starcoat	<b>827 Starcoat™</b>	1B	Good	85	2720	827	97
T5 Lamps	<b>830 Starcoat™</b>	1B	Good	85	2940	830	97
	<b>835 Starcoat™</b>	1B	Good	85	3450	835	97
	<b>840 Starcoat™</b>	1B	Good	85	4040	840	97
	<b>865 Starcoat™</b>	1B	Good	85	6500	860	95
Triphosphor	<b>827 Polyflux XLr™</b>	1B	Good	85	2720	827	93
Polyflux XLr	<b>830 Polyflux XLr™</b>	1B	Good	85	2940	830	93
Lamps	<b>835 Polyflux XLr™</b>	1B	Good	85	3450	835	93
	<b>840 Polyflux XLr™</b>	1B	Good	85	4040	840	93
	<b>860 Polyflux XLr™</b>	1B	Good	85	6400	860	90
Cov-R-Guard	<b>830 Cov-R-Guard Polyflux XLr™</b>	1B	Good	85	2940	830	93
Shielded	<b>835 Cov-R-Guard Polyflux XLr™</b>	1B	Good	85	3450	835	93
Fluorescent	<b>840 Cov-R-Guard Polyflux XLr™</b>	1B	Good	85	4040	840	93
Standard	29 Warm White	3	Low	51	2940	29	79
Halophosphate	35 White	3	Low	54	3450	35	79
	25 Natural/Universal White	2	Moderate	70	4000	25	72
	33 Cool white	3	Low	58	4040	33	79
	54 Daylight	2	Moderate	76	6500	54	65
Special	UV non-filter	-	NA	-	-	05	-
Colours	Blacklight Blue	-	NA	-	-	BLB	-

Avg. lm/W = average initial lumens per watt (based on 36W, 1.2M tube or 40W, 1.2M tube for special colours and Polyflux)  
Ra = colour rendering index (higher Ra gives better colour rendering, max= 100 NA=not applicable)



# Fluorescent selection guide

## Lumen value table

	Wattage	20	40	65	75	85	100	125	22	32	40	60	40
	length mm	600	1200	1500	1800	2400	2400	2400	209.5	311.2	412.6	412.6	525
	Lamp	T12 38 mm Ø											
		Circline											
		Mod-u-line											
Starcoat™	<b>827 Starcoat™</b>												
T5 Lamps	<b>830 Starcoat™</b>												
	<b>835 Starcoat™</b>												
	<b>840 Starcoat™</b>												
	<b>865 Starcoat™</b>												
Triphosphor	<b>827 Polylox XLr™</b>												
Polylox XLr	<b>830 Polylox XLr™</b>												
Lamps	<b>835 Polylox XLr™</b>												
	<b>840 Polylox XLr™</b>												
	<b>860 Polylox XLr™</b>												
Cov-R-Guard	<b>830 Polylox XLr™</b>												
Shielded	<b>835 Polylox XLr™</b>												
Fluorescent	<b>840 Polylox XLr™</b>												
Triphosphor	<b>827 Polylox</b>												
Polylox	<b>830 Polylox</b>	1350	3350	5300	6550	7900	9100	10000					
	<b>835 Polylox</b>											3250	
	<b>840 Polylox</b>	1350	3350	5300	6550	7900	9100						
Standard	<b>29 Warm White</b>	1150	2950	4750	5750							2875	
Halophosphate	<b>35 White</b>	1150	2950	4750	5750	7100	8300	9200					
	<b>25 Natural</b>												
	<b>Universal White</b>	1050	2500	4000				1000	1825	2700			
	<b>33 Cool white</b>	1150	2950	4750	5700			8100	9100	1100	1950	2700	2875
	<b>54 Daylight</b>	950	2450	3900				7500	1050	1750	2440		

### Product Description

Very warm, similar to incandescent light. Gives a warm effect in restaurants, hotels etc.  
 Warm, gives a welcoming effect. Used in restaurants, hotels, offices and supermarkets.  
 Intermediate colour, used in general, commercial and industrial lighting. Creates cool atmosphere in commercial installations. Very cool. Popular in warmer climates.

Very warm, similar to incandescent light. Gives a warm effect in restaurants, hotels etc.  
 Warm, gives a welcoming effect. Used in restaurants, hotels, offices and supermarkets.  
 Intermediate colour, used in general, commercial and industrial lighting.  
 Creates cool atmosphere in commercial installations. Recommended for hospitals.  
 Very cool. Popular in warmer climates.

Warm, gives a homely welcoming effect. Used in supermarkets, schools.  
 Intermediate colour, used in general, commercial and industrial lighting.  
 Creates cool atmosphere in commercial installations. Recommended for hospitals.

Warm, used in commercial or public buildings to create a "warm" atmosphere.  
 Intermediate colour, standard colour for almost all applications.  
 Cool, used in offices and shops. Higher colour rendering, but less efficient than cool white.  
 Cool, used to create a cooler atmosphere in offices, factories and shops.  
 Very cool. Popular in warmer climates.

Small amount of visible light with long wave UV-A radiation emitted to attract insects into insect traps.  
 Only long wave UV produced. Used decoratively in discos as the UV makes white fabrics fluorescent.

Special Colours are available in some sizes, please ask our sales department for more information.

# Fluorescent lamps

## Product identification

The following glossary of terms and descriptions can help you when checking fluorescent lamp specifications and explains how to use the product codes when ordering products. Within each product line, lamps are divided into families - within families, lamps are listed by wattage.

**Watts:** Energy used. To find actual energy used (kWh) multiply power (watts shown) x hours of use divided by 1000

**CRI Ra:** Colour rendering index, the higher the number (1-100) the more natural the lit subject appears

**Product Code:** It is important to use this code when ordering to ensure that you receive the exact product you require

**Length:**  
Expressed in feet and mm

**Product Description:**  
The lamp's identification code

**Product Type:**  
Identifies the lamp type

**Pack Quantity:**  
The number of lamps in one box

### Starcoat™ T5 High Efficiency (HE)

Use on HF Electronic Ballast only.

Watt	Length Ft	Length mm	Product Description	Product Type	CCT K	CRI Ra	Rated Average Life Hours	Initial lumens	Pack Qty	Product Code
T5 (Ø 16mm - 5/8")										
14		549	F14W/T5/827	STARCOAT/SL/1-30	2700	85	20000	1350	30	90230
			F14W/T5/830	STARCOAT/SL/1-30	3000	85	20000	1350	30	90239
			F14W/T5/835	STARCOAT/SL/1-30	3500	85	20000	1350	30	90246

**Lamp:**  
Lamp description followed by diameter (mm and inches)

**Initial Lumens:**  
Light output after the initial 100 hours of operation

### F14W/T5/827

Identifies lamp as fluorescent

Identifies lamp wattage

Identifies lamp type

Colour temperature code

8 27

Colour rendering of between 80-89

CCT nominal 2700 K

**CCT K:**  
Colour temperature - Kelvin. The visual warmth or coolness of the light. The higher the number the whiter or cooler the light appears

**Rated Average Life:**  
The point in time when 50% of installed lamps are still burning



# Taking efficiency to new levels

## T5WattMiser™

T5 Watt-Miser tubes use 5% less energy than other GE T5s, with the same lumen output - 25% more efficient than T8 Polylux types.

In fact, if the total system efficiency is taken into account then an energy saving as high as 45% can be achieved compared to systems using standard T8 tubes. This will have a big impact on reducing electricity expenses, which can account for over 90% of total lighting coast.



### How much can be saved?

Annual savings from a typical installation of 1000 lamps used for 5000 hours a year & energy costs of 0.11 €/kWh

	24W	40W	54W	80W
T5 power at 35°C (W/lamp)	22.1	49.1	53.8	80.0
T5 Watt-Miser power at 35°C (W/lamp)	21.4	46.8	51.1	76.0

T5 annual energy (kWh)	112,500	246,500	269,000	400,000
T5 Watt-Miser™ annual energy (kWh)	106,875	234,000	255,500	380,000

Annual energy saving (kWh)	5,625	12,500	13,500	20,000
----------------------------	-------	--------	--------	--------

Annual energy saving (€)	€ 563	€ 1,250	€ 1,350	€ 2,000
--------------------------	-------	---------	---------	---------

Payback **Less than 1 Year**

CO <sub>2</sub> saved in a year (tonns)*	2.1	4.6	5.0	7.4
--	-----	-----	-----	-----

\* conversion factor 0.42 CO<sub>2</sub>/kWh (with 1000-hr-watt decrease) UK - could change with region

### Benefits of Watt-Miser™

- 5% extra energy saving **with existing fitting & control gear**
- Reduces CO<sub>2</sub> **and other greenhouse gas emissions**
- **Energy saving** without loss of light output
- **Excellent** lumen maintenance
- Low mercury content
- ROHS compliant **and contains recyclable components**

### Applications

Ideal for applications with high energy costs:

- Offices
- Schools, colleges, public buildings
- Warehousing
- Industry
- Hypermarkets & supermarkets



# Fluorescent lamps

## T5 Watt-Miser™ High Efficiency

Actual Watt	Nominal Watt	Length mm	Product Description	CCT K	CRI Ra	Rated Average Life Hours (3-hr cycle)	Rated Average Life Hours (12-hr cycle)	Initial lumens at 35°C	Initial lumens at 25°C	Rated power at 35°C	Pack Qty	EE Class	Volts	I (A)	Product Code
13.0	14	549	F14/T5/830/GE/WATT-MISER/SL 1-30	3000	85	25000	30000	1350	1230	13.0	30	A	78	0.295	88364
			F14/T5/835/GE/WATT-MISER/SL 1-30	3500	85	25000	30000	1350	1230	13.0	30	A	78	0.295	88363
			F14/T5/840/GE/WATT-MISER/SL 1-30	4000	85	25000	30000	1350	1230	13.0	30	A	78	0.295	88362
19.7	21	849	F14/T5/865/GE/WATT-MISER/SL 1-30	6500	85	25000	30000	1250	1230	13.0	30	A	78	0.295	88361
			F21/T5/830/GE/WATT-MISER/SL 1-30	3000	85	25000	30000	2100	1910	19.7	30	A	117	0.295	88360
			F21/T5/835/GE/WATT-MISER/SL 1-30	3500	85	25000	30000	2100	1910	19.7	30	A	117	0.295	88358
26.4	28	1149	F21/T5/840/GE/WATT-MISER/SL 1-30	4000	85	25000	30000	2100	1910	19.7	30	A	117	0.295	88357
			F21/T5/865/GE/WATT-MISER/SL 1-30	6500	85	25000	30000	1950	1910	19.7	30	A	117	0.295	88359
			F28/T5/830/GE/WATT-MISER/SL 1-30	3000	85	25000	30000	2900	2640	26.4	30	A	159	0.295	88345
33.0	35	1449	F28/T5/835/GE/WATT-MISER/SL 1-30	3500	85	25000	30000	2900	2640	26.4	30	A	159	0.295	88346
			F28/T5/840/GE/WATT-MISER/SL 1-30	4000	85	25000	30000	2900	2640	26.4	30	A	159	0.295	88356
			F28/T5/865/GE/WATT-MISER/SL 1-30	6500	85	25000	30000	2700	2640	26.4	30	A	159	0.295	88341
33.0	35	1449	F35/T5/830/GE/WATT-MISER/SL 1-30	3000	85	25000	30000	3650	3320	33.0	30	A	199	0.295	88355
			F35/T5/835/GE/WATT-MISER/SL 1-30	3500	85	25000	30000	3650	3320	33.0	30	A	199	0.295	88342
			F35/T5/840/GE/WATT-MISER/SL 1-30	4000	85	25000	30000	3650	3320	33.0	30	A	199	0.295	88354
			F35/T5/865/GE/WATT-MISER/SL 1-30	6500	85	25000	30000	3400	3320	33.0	30	A	199	0.295	88353

## T5 Watt-Miser™ High Output

21.4	24	549	F24/T5/830/GE/WATT-MISER/SL 1-30	3000	85	25000	30000	2000	1750	21.4	30	A	71	0.650	88352
			F24/T5/835/GE/WATT-MISER/SL 1-30	3500	85	25000	30000	2000	1750	21.4	30	A	71	0.650	88351
			F24/T5/840/GE/WATT-MISER/SL 1-30	4000	85	25000	30000	2000	1750	21.4	30	A	71	0.650	88350
36.1	39	849	F24/T5/865/GE/WATT-MISER/SL 1-30	6500	85	25000	30000	1900	1750	21.4	30	A	71	0.650	88349
			F39/T5/830/GE/WATT-MISER/SL 1-30	3000	85	25000	30000	3500	3200	36.1	30	A	106	0.650	88348
			F39/T5/835/GE/WATT-MISER/SL 1-30	3500	85	25000	30000	3500	3200	36.1	30	A	106	0.650	88347
46.8	49	1449	F39/T5/840/GE/WATT-MISER/SL 1-30	4000	85	25000	30000	3500	3200	36.1	30	A	106	0.650	88344
			F39/T5/865/GE/WATT-MISER/SL 1-30	6500	85	25000	30000	3330	3200	36.1	30	A	106	0.650	88334
			F49/T5/830/GE/WATT-MISER/SL 1-30	3000	85	25000	30000	4900	4450	46.8	30	A	181	0.480	88343
51.5	54	1149	F49/T5/835/GE/WATT-MISER/SL 1-30	3500	85	25000	30000	4900	4450	46.8	30	A	181	0.480	88339
			F49/T5/840/GE/WATT-MISER/SL 1-30	4000	85	25000	30000	4900	4450	46.8	30	A	181	0.480	88336
			F49/T5/865/GE/WATT-MISER/SL 1-30	6500	85	25000	30000	4650	4450	46.8	30	A	181	0.480	88340
76.0	80	1449	F54/T5/830/GE/WATT-MISER/SL 1-30	3000	85	25000	30000	5000	4460	51.1	30	A	112	0.890	88328
			F54/T5/835/GE/WATT-MISER/SL 1-30	3500	85	25000	30000	5000	4460	51.1	30	A	112	0.890	88338
			F54/T5/840/GE/WATT-MISER/SL 1-30	4000	85	25000	30000	5000	4460	51.1	30	A	112	0.890	88337
76.0	80	1449	F54/T5/865/GE/WATT-MISER/SL 1-30	6500	85	25000	30000	4750	4460	51.1	30	A	112	0.890	88333
			F80/T5/830/GE/WATT-MISER/SL 1-30	3000	85	25000	30000	7000	6450	76.0	30	A	138	0.970	88329
			F80/T5/835/GE/WATT-MISER/SL 1-30	3500	85	25000	30000	7000	6450	76.0	30	A	138	0.970	88330
			F80/T5/840/GE/WATT-MISER/SL 1-30	4000	85	25000	30000	7000	6450	76.0	30	A	138	0.970	88332
			F80/T5/865/GE/WATT-MISER/SL 1-30	6500	85	25000	30000	6650	6450	76.0	30	A	138	0.970	88331



# Lead free Starcoat™ T5 with enhanced life time Efficiency with Elegance in Design

**GE's efficient fluorescent that comes in a small size and provides big lumen output for visual comfort.** High lumen in a small, lower package enabling visual comfort and performance for more productive office and retail environments.



## Efficiency

GE T5 Starcoat™ is small in size but offers great output. With nine wattages to choose from, you can either maximize your lumen output or your efficiency.

**High Efficiency range**

up to 104 lumens per watt, suited to commercial and retail application in both direct/indirect luminaires

**High Output lamps**

up to 7000 lumens improved system efficacy and reduced number of fittings, ideal for indirect luminaires.

## Starcoat™ technology Environmentally responsible design



**GE's T5 lamps feature:**

- 38% less glass and phosphors than T8 lamps which means reduced waste in landfills
- lead free products
- low mercury content
- less lamps are needed to maintain same lumen output due to the high output design
- ROHS compliant & contains recyclable components.

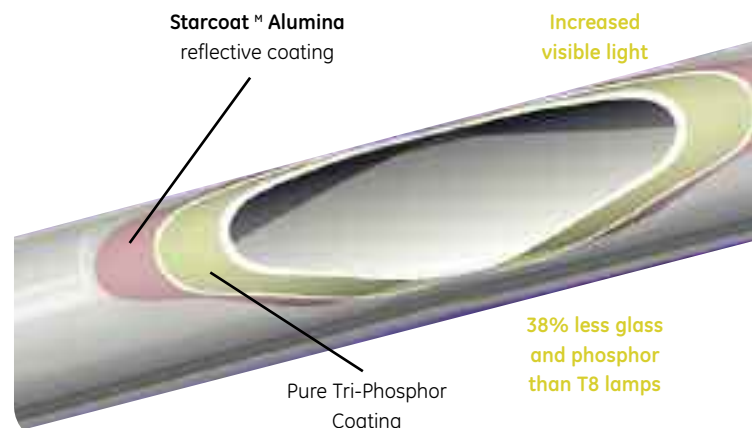

## LongLast™ Starcoat™ T5 High Efficiency (HE) lead free products

Watt	Length mm	Product Description	CCT K	CRI Ra	Rated Average Life Hours (3-hr cycle)	Rated Average Life Hours (12-hr cycle)	Initial lumens at 35°C	Initial lumens at 25°C	Pack Qty	EE Class	Volts	I (A)	Product Code
<b>T5 (Ø 16mm - 5/8")</b>													
14	549	F14W/T5/827	2720	85	30000	36000	1350	1230	30	A	86	0.165	90230
14		F14W/T5/830	2940	85	30000	36000	1350	1230	30	A	86	0.165	90239
14		F14W/T5/835	3450	85	30000	36000	1350	1230	30	A	86	0.165	90246
14		F14W/T5/840	4040	85	30000	36000	1350	1230	30	A	86	0.165	90247
14		F14W/T5/865	6500	85	30000	36000	1250	1140	30	A	86	0.165	90244
21	849	F21W/T5/827	2720	85	30000	36000	2100	1910	30	A	126	0.165	90245
21		F21W/T5/830	2940	85	30000	36000	2100	1910	30	A	126	0.165	90248
21		F21W/T5/835	3450	85	30000	36000	2100	1910	30	A	126	0.165	90249
21		F21W/T5/840	4040	85	30000	36000	2100	1910	30	A	126	0.165	90250
21		F21W/T5/865	6500	85	30000	36000	1950	1770	30	A	126	0.165	90251
28	1149	F28W/T5/827	2720	85	30000	36000	2900	2640	30	A	166	0.17	90252
28		F28W/T5/830	2940	85	30000	36000	2900	2640	30	A	166	0.17	90253
28		F28W/T5/835	3450	85	30000	36000	2900	2640	30	A	166	0.17	90254
28		F28W/T5/840	4040	85	30000	36000	2900	2640	30	A	166	0.17	90255
28		F28W/T5/865	6500	85	30000	36000	2700	2450	30	A	166	0.17	90256
35	1449	F35W/T5/827	2720	85	30000	36000	3650	3320	30	A	205	0.175	90257
35		F35W/T5/830	2940	85	30000	36000	3650	3320	30	A	205	0.175	90258
35		F35W/T5/835	3450	85	30000	36000	3650	3320	30	A	205	0.175	90259
35		F35W/T5/840	4040	85	30000	36000	3650	3320	30	A	205	0.175	90260
35		F35W/T5/865	6500	85	30000	36000	3400	3090	30	A	205	0.175	90261
<b>INDUSTRIAL PACK</b>													
14	549	F14W/T5/827	2720	85	30000	36000	1350	1230	40	A	86	0.165	39965
		F14W/T5/830	2940	85	30000	36000	1350	1230	40	A	86	0.165	39964
		F14W/T5/835	3450	85	30000	36000	1350	1230	40	A	86	0.165	39961
		F14W/T5/840	4040	85	30000	36000	1350	1230	40	A	86	0.165	39973
		F14W/T5/865	6500	85	30000	36000	1250	1140	40	A	86	0.165	90222
21	849	F21W/T5/827	2720	85	30000	36000	2100	1910	40	A	126	0.165	39976
		F21W/T5/830	2940	85	30000	36000	2100	1910	40	A	126	0.165	39977
		F21W/T5/835	3450	85	30000	36000	2100	1910	40	A	126	0.165	39977
		F21W/T5/840	4040	85	30000	36000	2100	1910	40	A	126	0.165	39978
		F21W/T5/865	6500	85	30000	36000	1950	1770	40	A	126	0.165	39979
28	1149	F28W/T5/827	2720	85	30000	36000	2900	2640	40	A	166	0.17	39980
		F28W/T5/830	2940	85	30000	36000	2900	2640	40	A	166	0.17	39982
		F28W/T5/835	3450	85	30000	36000	2900	2640	40	A	166	0.17	39983
		F28W/T5/840	4040	85	30000	36000	2900	2640	40	A	166	0.17	39984
		F28W/T5/865	6500	85	30000	36000	2700	2450	40	A	166	0.17	39985
35	1449	F35W/T5/827	2720	85	30000	36000	3650	3320	40	A	205	0.175	39986
		F35W/T5/830	2940	85	30000	36000	3650	3320	40	A	205	0.175	39989
		F35W/T5/835	3450	85	30000	36000	3650	3320	40	A	205	0.175	39990
		F35W/T5/840	4040	85	30000	36000	3650	3320	40	A	205	0.175	39991
		F35W/T5/865	6500	85	30000	36000	3400	3090	40	A	205	0.175	39992

## LongLast™ Starcoat™ T5 High Output (HO) lead free products

Watt	Length mm	Product Description	CCT K	CRI Ra	Rated Average Life Hours (3-hr cycle)	Rated Average Life Hours (12-hr cycle)	Initial lumens at 35°C	Initial lumens at 25°C	Pack Qty	EE Class	Volts	I (A)	Product Code
<b>T5 (Ø 16mm - 5/8")</b>													
24	549	F24W/T5/827	2720	85	30000	36000	2000	1750	30	A	77	0.295	90262
		F24W/T5/830	2940	85	30000	36000	2000	1750	30	A	77	0.295	90264
		F24W/T5/835	3450	85	30000	36000	2000	1750	30	A	77	0.295	90264
		F24W/T5/840	4040	85	30000	36000	2000	1750	30	A	77	0.295	90265
		F24W/T5/865	6500	85	30000	36000	1900	1600	30	A	77	0.295	90266
39	849	F39W/T5/827	2720	85	30000	36000	3500	3200	30	A	118	0.325	90267
		F39W/T5/830	2940	85	30000	36000	3500	3200	30	A	118	0.325	90268
		F39W/T5/835	3450	85	30000	36000	3500	3200	30	A	118	0.325	90269
		F39W/T5/840	4040	85	30000	36000	3500	3200	30	A	118	0.325	90270
		F39W/T5/865	6500	85	30000	36000	3330	2950	30	A	118	0.325	90271
49	1449	F49W/T5/827	2720	85	30000	36000	4900	4450	30	A	195	0.255	90277
		F49W/T5/830	2940	85	30000	36000	4900	4450	30	A	195	0.255	90278
		F49W/T5/835	3450	85	30000	36000	4900	4450	30	A	195	0.255	90279
		F49W/T5/840	4040	85	30000	36000	4900	4450	30	A	195	0.255	90280
		F49W/T5/865	6500	85	30000	36000	4650	4100	30	A	195	0.255	90281
54	1149	F54W/T5/827	2720	85	30000	36000	5000	4460	30	A	120	0.455	90272
		F54W/T5/830	2940	85	30000	36000	5000	4460	30	A	120	0.455	90273
		F54W/T5/835	3450	85	30000	36000	5000	4460	30	A	120	0.455	90274
		F54W/T5/840	4040	85	30000	36000	5000	4460	30	A	120	0.455	90275
		F54W/T5/865	6500	85	30000	36000	4750	4100	30	A	120	0.455	90276
80	1449	F80W/T5/827	2720	85	30000	36000	7000	6450	30	A	152	0.53	90282
		F80W/T5/830	2940	85	30000	36000	7000	6450	30	A	152	0.53	90283
		F80W/T5/840	4040	85	30000	36000	7000	6450	30	A	152	0.53	90285
		F80W/T5/865	6500	85	30000	36000	6650	5950	30	A	152	0.53	90286



# Fluorescent lamps

Watt	Length mm	Product Description	CCT K	CRI Ra	Rated Average Life Hours (3-hr cycle)	Rated Average Life Hours (12-hr cycle)	Initial lumens at 35°C	Initial lumens at 25°C	Pack Qty	EE Class	Volts	I (A)	Product Code
<b>INDUSTRIAL PACK</b>													
<b>24</b>	549	<b>F24W/T5/827</b>	2720	85	30000	36000	2000	1750	40	A	77	0.295	<b>39994</b>
		<b>F24W/T5/830</b>	2940	85	30000	36000	2000	1750	40	A	77	0.295	<b>39998</b>
		<b>F24W/T5/835</b>	3450	85	30000	36000	2000	1750	40	A	77	0.295	<b>90196</b>
		<b>F24W/T5/840</b>	4040	85	30000	36000	2000	1750	40	A	77	0.295	<b>90197</b>
		<b>F24W/T5/865</b>	6500	85	30000	36000	1900	1600	40	A	77	0.295	<b>90198</b>
<b>39</b>	849	<b>F39W/T5/827</b>	2720	85	30000	36000	3500	3200	40	A	118	0.325	<b>90200</b>
		<b>F39W/T5/830</b>	2940	85	30000	36000	3500	3200	40	A	118	0.325	<b>90201</b>
		<b>F39W/T5/835</b>	3450	85	30000	36000	3500	3200	40	A	118	0.325	<b>90202</b>
		<b>F39W/T5/840</b>	4040	85	30000	36000	3500	3200	40	A	118	0.325	<b>90203</b>
		<b>F39W/T5/865</b>	6500	85	30000	36000	3330	2950	40	A	118	0.325	<b>90204</b>
<b>49</b>	1449	<b>F49W/T5/827</b>	2720	85	30000	36000	4900	4450	40	A	195	0.255	<b>90220</b>
		<b>F49W/T5/830</b>	2940	85	30000	36000	4900	4450	40	A	195	0.255	<b>90219</b>
		<b>F49W/T5/835</b>	3450	85	30000	36000	4900	4450	40	A	195	0.255	<b>90221</b>
		<b>F49W/T5/840</b>	4040	85	30000	36000	4900	4450	40	A	195	0.255	<b>90223</b>
		<b>F49W/T5/865</b>	6500	85	30000	36000	4650	4100	40	A	195	0.255	<b>90224</b>
<b>54</b>	1149	<b>F54W/T5/827</b>	2720	85	30000	36000	5000	4460	40	A	120	0.455	<b>90205</b>
		<b>F54W/T5/830</b>	2940	85	30000	36000	5000	4460	40	A	120	0.455	<b>90232</b>
		<b>F54W/T5/835</b>	3450	85	30000	36000	5000	4460	40	A	120	0.455	<b>90206</b>
		<b>F54W/T5/840</b>	4040	85	30000	36000	5000	4460	40	A	120	0.455	<b>90209</b>
		<b>F54W/T5/865</b>	6500	85	30000	36000	4750	4100	40	A	120	0.455	<b>90211</b>
<b>80</b>	1449	<b>F80W/T5/827</b>	2720	85	30000	36000	7000	6450	40	A	152	0.53	<b>90225</b>
		<b>F80W/T5/830</b>	2940	85	30000	36000	7000	6450	40	A	152	0.53	<b>90226</b>
		<b>F80W/T5/835</b>	3450	85	30000	36000	7000	6450	40	A	152	0.53	<b>90227</b>
		<b>F80W/T5/840</b>	4040	85	30000	36000	7000	6450	40	A	152	0.53	<b>90228</b>
		<b>F80W/T5/865</b>	6500	85	30000	36000	6650	5950	40	B	152	0.53	<b>90229</b>



## GE Electronic T5 Ballast

Watts	with 1 lamp Product Description	Product Code	with 2 lamp Product Description	Product Code	with 3 lamp Product Description	Product Code	with 4 lamp Product Description	Product Code
<b>High Efficiency</b>								
14	BLS/E/1x14-21-28-35W/T5	70927	BLS/E/2x14-21-28-35W/T5	70905	BLS/E/3-4x14W/T5	70908	BLS/E/3-4x14W/T5	70908
21	BLS/E/1x14-21-28-35W/T5	70927	BLS/E/2x14-21-28-35W/T5	70905				
28	BLS/E/1x14-21-28-35W/T5	70927	BLS/E/2x14-21-28-35W/T5	70905				
35	BLS/E/1x14-21-28-35W/T5	70927	BLS/E/2x14-21-28-35W/T5	70905				
<b>High Output</b>								
24	BLS/E/2x24W/T5	70914						
39			BLS/E/2x39W/T5	70915				
54			BLS/E/2x54W/T5	70912				
80	BLS/E/1x80W/T5	70913						

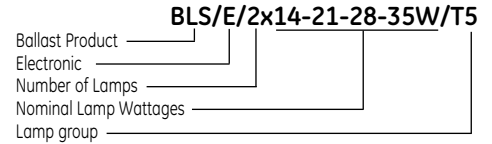

## GE Electronic Ultrastart™ Ballast

Model	Line Volts	No. of Lamps	Lamp Type	Input Watts	Normal Line Amps	Ballast Factor	Power Factor	Harmonic Total	Crest Factor	CELMA EE=A2	Product Code
<b>BLS/E/2x14-21-28-35W</b>	230	2	F35T5HE	77.5	0.34	1.00	0.99	6.0%	1.52	YES	<b>88679</b>
	230	2	F28T5HE	62.2	0.28	0.99	0.98	6.6%	1.51	YES	
	230	2	F21T5HE	50.4	0.23	1.04	0.97	7.4%	1.60	YES	
	230	2	F14T5HE	35.8	0.17	1.05	0.93	8.6%	1.62	YES	
<b>BLS/E/3-4x14W</b>	230	4	F14T5WM	59.1	0.26	1.00	0.99	6.2%	1.59	YES	<b>88678</b>
	230	3	F14T5WM	46.1	0.20	1.02	0.98	7.1%	1.52	YES	
	230	4	F14T5HE	63.5	0.28	1.02	0.99	6.2%	1.59	YES	
	230	3	F14T5HE	49.5	0.22	1.04	0.98	6.8%	1.52	YES	

## T5 Miniature

Watt	Length Ft	Length mm	Product Description	Colour/ Product Type	CCT K	CRI Ra	Rated Average Life Hours	Initial lumens at 35°C	Pack Qty	EE Class	Volts	I (A)	Product Code
T5 (Ø 16mm - 5/8") Standard Halophosphate													
<b>4</b>	6in	150	<b>F4W/33</b>	Cool White	4040	58	5000	130	25	B	29	0.17	<b>39441</b>
			<b>F4W/35</b>	White	3450	54	5000	130	25	B			<b>39446</b>
<b>6</b>	9in	225	<b>F6W/33</b>	Cool White	4040	58	5000	260	25	B	42	0.16	<b>39445</b>
			<b>F6W/35</b>	White	3450	54	5000	260	25	B			<b>39442</b>
<b>8</b>	12in	300	<b>F8W/29</b>	Warm White	2940	51	5000	395	25	B	56	0.145	<b>37754</b>
			<b>F8W/33</b>	Cool White	4040	58	5000	395	25	B			<b>37755</b>
			<b>F8W/33BP</b>	Cool White	4040	58	5000	395	100	B			<b>37001</b>
			<b>F8W/35</b>	White	3450	54	5000	395	25	B			<b>37756</b>
<b>13</b>	21in	525	<b>F13W/29</b>	Warm White	2940	51	5000	850	25	B	95	0.165	<b>39437</b>
			<b>F13W/33</b>	Cool White	4040	58	5000	850	25	B			<b>39440</b>
			<b>F13W/35</b>	White	3450	54	5000	850	25	B			<b>39439</b>

## T5 Polylux

<b>8</b>	12in	300	<b>F8W/827BP</b>	Polylux 827	2720	80+	5000	460	100	B	56	0.143	<b>37008</b>
			<b>F8W/840BP</b>	Polylux 840	4040	80+	5000	460	100	B	56	0.143	<b>37009</b>
<b>13</b>	21in	525	<b>F13W/827</b>	Polylux 827	2720	80+	5000	970	25	B	95	0.137	<b>39447</b>

## Specfill (Emergency Lighting)

<b>6</b>	225	<b>F6W/T5/Specfill/33Bulk</b>	Cool White				8000	260	100	B	42		<b>40307</b>
<b>6</b>	225	<b>F6W/T5/Specfill/35Bulk</b>	White				8000	260	100	B	42		<b>40322</b>
<b>6</b>	225	<b>F6W/T5/Specfill/840Bulk</b>	Polylux 840				8000	300	100	B	42		<b>40327</b>
<b>8</b>	300	<b>F8/T5/33/GE</b>	Cool White				8000	390	100	B	56		<b>91450</b>
<b>8</b>	300	<b>F8/T5/35/GE</b>	White				8000	400	100	B	56		<b>91451</b>
<b>8</b>	300	<b>F8/T5/33/GE</b>	Cool White				8000	400	25	B	56		<b>27011</b>
<b>8</b>	300	<b>F8/T5/35/GE</b>	White				8000	400	25	B	56		<b>27027</b>
<b>8</b>	300		Polylux 840				8000	460	100	B	56		<b>40331</b>
<b>13</b>	525	<b>F13W/T5/Specfill/840Bulk</b>	Polylux™ 840				8000	970	100	B	56		<b>45695</b>

## T5 Blacklight Blue

Watt	Length Ft	Length mm	Product Description	Colour Type	CCT K	Spectral Peak	Rated Average Life Hours	Irradiance nW/cm²	Pack Qty	EE Class	Cap	Product Code
T5 (Ø 16mm - 5/8")												
<b>4</b>	6in	150	<b>F4W/BLB Blacklight Blue</b>	-	368nm	368nm	5000	5.4	25	B	G5	<b>39882</b>
<b>6</b>	9in	225	<b>F6W/BLB Blacklight Blue</b>	-	368nm	368nm	5000	9.7	25	B	G5	<b>39883</b>
<b>8</b>	12in	300	<b>F8W/BLB Blacklight Blue</b>	-	368nm	368nm	6000	14	25	B	G5	<b>39884</b>



## T5 Miniature Standard, Polylux™ and Specfill™ Lamps

### T5 Miniature Lamps



T5 Miniature fluorescent lamps are designed for confined spaces in household and industrial applications. These lamps are widely used in different applications such as furniture cabinets, mobile homes as well as sign illumination. T5 Miniature lamps are well suited for use in maintained and non-maintained emergency modules and escape signs. All T5 lamps are environmentally friendly products – ROHS compliant & contains recyclable components.



# Fluorescent lamps

## Polylux XLR™ Triphosphor fluorescent tubes



### Less lamps – more light

GE Polylux XLR™ lamps with excellent lumen output, energy efficiency up to 93lm/Watt:

- Extra long life 20,000 hours\*
- Excellent colour rendering (CRI Ra: 85) and superior lumen maintenance
- Superior service life of 13,000 hours on 3 hours burning cycle
- Precise mercury dosing system push early failure level down to a minimum
- Extended relamping cycles
- Increased performance reliability between relamping cycle
- Less waste over time – lamp disposal and packaging
- Up to 18% more light
- Fewer lamps are required to achieve the same illumination level

\*15,000 hours life on conventional gear - Average rated life to 50% survival based on 3 hours switching cycle in accordance with International Standard IEC60082/EN60081



### Colour 827 (Extra Warm)

- Restaurants
- Hotels
- Plazas



### Colour 830 (Warm White)

- Retail
- Schools, gyms
- Reception areas



### Colour 840 (Cool White)

- Offices
- Sport halls
- Hospitals



### Colour 835 (White)

- General
- Commercial/industrial



### Colour 860 (Daylight)

- Display/Galleries
- Specialist industries (e.g. Textiles, Printing)



## T8 Polylux XLR™ – Reduced mercury and recyclable

Watt	Length Ft	Length mm	Product Description	Product Type	CCT K	CRI Ra	Rated Average Life Hours	Initial lumens at 25°C	Pack Qty	EE Class	Product Code
T8 (ø26mm – 1")											
15	18 in	450	F15W/827	PolyLux XLR 827	2720	85	15000	1000	25	B	23247
			F15W/830	PolyLux XLR 830	2940	85	15000	1000	25	B	23248
			F15W/840	PolyLux XLR 840	4040	85	15000	1000	25	B	23249
18	2ft	600	F18W/827	PolyLux XLR 827	2720	85	15000	1350	25	A	93315
			F18W/830	PolyLux XLR 830	2940	85	15000	1350	25	A	93319
			F18W/835	PolyLux XLR 835	3450	85	15000	1350	25	A	93311
			F18W/840	PolyLux XLR 840	4040	85	15000	1350	25	A	93317
			F18W/860	PolyLux XLR 860	6400	85	15000	1300	25	A	12606
30	3ft	900	F30W/827	PolyLux XLR 827	2720	85	15000	2450	25	A	18138
			F30W/830	PolyLux XLR 830	2940	85	15000	2450	25	A	18141
			F30W/840	PolyLux XLR 840	4040	85	15000	2450	25	A	18142
36		970	F36W1M/830	PolyLux XLR 830	2940	85	15000	3100	25	A	23260
			F36W1M/840	PolyLux XLR 840	4040	85	15000	3100	25	A	23262
36	4ft	1200	F36W/827	PolyLux XLR 830	2720	85	15000	3350	25	A	19977
			F36W/830	PolyLux XLR 840	2940	85	15000	3350	25	A	18192
			F36W/835	PolyLux XLR 835	3450	85	15000	3350	25	A	19991
			F36W/840	PolyLux XLR 840	4040	85	15000	3350	25	A	16856
			F36W/860	PolyLux XLR 860	6400	85	15000	3250	25	A	12942
58	5ft	1500	F58W/827	PolyLux XLR 827	2720	85	15000	5200	25	A	93330
			F58W/830	PolyLux XLR 830	2940	85	15000	5200	25	A	93334
			F58W/835	PolyLux XLR 835	3450	85	15000	5200	25	A	93331
			F58W/840	PolyLux XLR 840	4040	85	15000	5200	25	A	93333
			F58W/860	PolyLux XLR 860	6400	85	15000	5000	25	A	12943
70	6ft	1800	F70W/830	PolyLux XLR 830	2940	85	15000	6300	25	A	42791
			F70W/835	PolyLux XLR 835	3450	85	15000	6300	25	A	42792
			F70W/840	PolyLux XLR 840	4040	85	15000	6300	25	A	42793

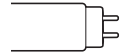

PolyLux XLR™ Rated Average Life on HF Electronic gear: 20000 hrs

## GE Electronic T8 Ballast

Watts	with 1 lamp		with 2 lamp		with 3 lamp		with 4 lamp	
	Product Description	Product Code	Product Description	Product Code	Product Description	Product Code	Product Description	Product Code
18	BLS/E/1x18W/T8	70917	BLS/E/2x18W/T8	70918	BLS/E/3-4x18W/T8	70919	BLS/E/3-4x18W/T8	70919
36	BLS/E/1x36W/T8	70921	BLS/E/2x36W/T8	70922				
58	BLS/E/1x58W/T8	70923	BLS/E/2x58W/T8	70924				
70	BLS/E/1x70W/T8	70926	BLS/E/2x70W/T8	70925				

### BLS/E/2x18W/T8

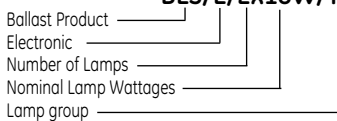

# Fluorescent lamps

## T8 Polylux™ XLR™ LongLast Range

Outstanding reliability with up to 42,000 hours life!

In today's business environment there is an increased need for lighting products that help to minimize operational costs and yet also provide environmentally responsible design.

GE's T8 Polylux™ XLR™ LongLast range was designed to further improve reliability and drastically increase life performance without compromising on initial lumen and lumen maintenance.

### Benefits

- Long and reliable product life – up to 42,000 hours
- Superior service life – up to 32,000 hours – ideal for group replacements
- Comprehensive product range – 18W, 36W, 58W and 70W
- Best in class performance - light output is same as for standard T8 Polylux™ XLR™
- Excellent lumen maintenance
- Outstanding color rendering through the advanced XLR™ coating technology
- Environmentally friendly product – ROHS compliant & contains recyclable components
- Can be used on existing control gears and fixtures

### Application

GE Polylux™ T8 XLR™ LongLast range is an ideal choice for applications with high maintenance costs:

- Store lighting
- Warehouse lighting
- Industrial lighting
- Public buildings and areas



Life Expectancy

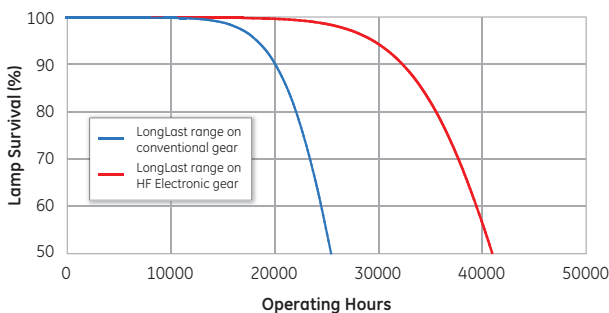

Service Life

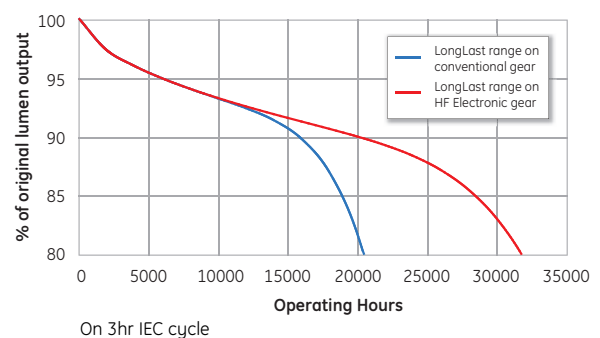

### T8 Polylux™ XLR™ LongLast Range

Watts	Length (mm)	Product Description	CCT K	Initial Lumens	CRI	Average life	Service life	Product Code
T8 (ø 26 mm – 1")								
18	600	F18W/T8/XLR/LL/830	2940	1350	85	42000	32000	70980
18	600	F18W/T8/XLR/LL/840	4040	1350	85	42000	32000	70981
36	1200	F36W/T8/XLR/LL/830	2940	3350	85	42000	32000	43508
36	1200	F36W/T8/XLR/LL/840	4040	3350	85	42000	32000	43509
58	1500	F58W/T8/XLR/LL/830	2940	5200	85	42000	32000	43510
58	1500	F58W/T8/XLR/LL/840	4040	5200	85	42000	32000	43511
70	1800	F70W/T8/XLR/LL/830	2940	6300	85	42000	32000	43513
70	1800	F70W/T8/XLR/LL/840	4040	6300	85	42000	32000	43514

Average life on conventional gear: 24000hrs  
Service life on conventional gear: 21000hrs



## T8 Watt-Miser™ lamp

GE's new Watt-Miser™ fluorescent range will save money on your lighting costs. They use less energy than similar products on the market and help reduce your organisation's carbon footprint.

GE is working hard to develop technology that reduces the environmental impact of its lighting products. The Watt-Miser™ range of lamps are ideal for office, retail, property management, commercial and industrial applications where lighting is a significant part of energy costs and hence where significant energy savings can be made.



### Energy Savers

- More than 10% energy saving with existing fittings and control gear
- Same colour performance, life and lumen maintenance as Triphosphor T8
- Excellent lumen maintenance



### T8 Watt-Miser™

Nominal Watt	Actual Watt	Length mm	Product Description	Product Type	CCT K	CRI Ra	Rated Average Life Hours	Pack Qty	EE Class	Product Code
18	16	600	TU F18/T8/830/GE/ 16W WATT-MISER/SL 1-25	Polylux XLR 830	2940	85	15000	25	A	73605
18	16	600	TU F18/T8/835/GE/ 16W WATT-MISER/SL 1-25	Polylux XLR 835	3450	85	15000	25	A	73606
18	16	600	TU F18/T8/840/GE/ 16W WATT-MISER/SL 1-25	Polylux XLR 840	4040	85	15000	25	A	73607
18	16	600	TU F18/T8/860/GE/ 16W WATT-MISER/SL 1-25	Polylux XLR 860	6400	85	15000	25	A	73608
36	32	1200	TU F36/T8/830/GE/32W WATT-MISER/SL 1-25	Polylux XLR 830	2940	85	15000	25	A	96748
36	32	1200	TU F36/T8/835/GE/32W WATT-MISER/SL 1-25	Polylux XLR 835	3450	85	15000	25	A	96749
36	32	1200	TU F36/T8/840/GE/32W WATT-MISER/SL 1-25	Polylux XLR 840	4040	85	15000	25	A	96750
36	32	1200	TU F36/T8/860/GE/32W WATT-MISER/SL 1-25	Polylux XLR 860	6400	85	15000	25	A	96747



## T8 Standard Halophosphate

Watt	Length Ft	Length mm	Product Description	Colour Type	CCT K	CRI Ra	Rated Average Life Hours	Initial lumens	Pack Qty	EE Class	Product Code
T8 (Ø 26mm - 1")											
15	18in	450	F15W/29	Warm White	2940	51	9000	850	25	B	29527
			F15W/35	White	3450	54	9000	850	25	B	29531
			F15W/25	Natural White	4000	70	9000	775	25	B	29533
			F15W/33	Cool White	4040	58	9000	850	25	B	29524
			F15W/54	Daylight	6400	76	9000	750	25	B	29534
			F15W/55	Northlight	6300	93	9000	550	25	B	29687
18	2ft	600	F18W/29	Warm White	2940	51	9000	1150	25	B	29546
			F18W/35	White	3450	54	9000	1150	25	B	37139
			F18W/33	Cool White	4040	58	9000	1150	25	B	35098
			F18W/25	Natural	4000	70	9000	1100	25	B	29548
			F18W/54	Daylight	6400	76	9000	950	25	B	34883
30	3ft	900	F30W/29	Warm White	2940	51	9000	2250	25	B	18145
			F30W/35	White	3450	54	9000	2250	25	B	18147
			F30W/33	Cool White	4040	58	9000	2175	25	B	18137
			F30W/25	Natural	4000	70	9000	1900	25	B	17525
			F30W/54	Daylight	6000	76	9000	1850	25	B	18146
36	-	970	F36WM/33	Cool White	4040	58	9000	2600	25	B	92518
			F36WM/25	Natural	4000	70	9000	2250	25	B	92517
			F36WM/54	Daylight	6400	76	9000	1900	25	B	92519
36	4ft	1200	F36W/29	Warm White	2940	51	9000	2850	25	B	29565
			F36W/35	White	3450	54	9000	2850	25	B	37734
			F36W/33	Cool White	4040	58	9000	2850	25	B	35099
			F36W/54	Daylight	6400	76	9000	2350	25	B	34886
			F36W/25	Natural	4000	70	9000	2600	25	B	29568
38	3.5ft	1050	F38W/35	White	3450	54	9000	2850	25	B	92520
58	5ft	1500	F58W/29	Warm White	2940	51	9000	4600	25	B	29571/ 35354*
			F58W/35	White	3450	54	9000	4600	25	B	29575/ 37627*
			F58W/33	Cool White	4000	58	9000	4600	25	B	29570/ 35353*
			F58W/25	Natural	4040	70	9000	4100	25	B	29577
			F58W/54	Daylight	6400	76	9000	3750	25	B	29580/ 35355*
70	6ft	1800	F70W/29	Warm White	2940	51	9000	5550	25	B	40681
			F70W/35	White	3450	54	9000	5550	25	B	40683
			F70W/33	Cool White	4040	58	9000	5450	25	B	40679

\* Products for UK and Ireland market



## Don't let an accident cause an incident



Cov-R-Guard™

In some situations a broken tube could have serious consequences. For example, fragments of glass could fall on a food production line, merchandise, employees, customers, or somewhere out of sight. This could typically happen due to accidental impact or during re-lamping. GE shatter protection covRguard™ T5 tubes combine the efficiency of T5 tubes with the safety of a protective sleeve which effectively contains the glass fragments and phosphors if the lamp is broken. In some situations regulations stipulate protection and covRguard™ is the perfect solution.

- Complete shatter protection
- Quality protective sleeving
- Dependable UV- blocking
- Safety without sacrificing performance
- Cov-R-Guard™ lamps benefit from Polylux XLR™ triphosphor technology
- Long life
- Outstanding colour reproduction
- Excellent light output over life
- Reduced mercury content

### Cov-R-Guard™ lamps

Wrapped in a casing of polycarbonate plastic that effectively contains glass fragments and phosphor if the lamp is broken. The casing allows for maximum protection with minimum light loss – keeping your installation bright and safe. Both the casing and the lamp are fully recyclable, once separated.



### Applications:

- food processing • hospitals • supermarkets
- schools • pharmaceutical • commercial kitchens
- trains

## T8 Cov-R-Guard™ Polylux XLR™ – with Polycarbonate Shield

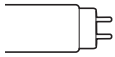

Watt	Length Ft	Length mm	Product Description	Product Type	CCT K	CRI Ra	Rated Average Life Hours	Initial lumens at 25°C	Pack Qty	EE Class	Product Code
T8 (∅ 26mm – 1")											
18	2ft	600	F18W/830	CVG/XLR 830	2940	85	15000	1300	25	A	17203
			F18W/835	CVG/XLR 835	3450	85	15000	1300	25	A	17204
			F18W/840	CVG/XLR 840	4040	85	15000	1300	25	A	17205
36	4ft	1200	F36W/830	CVG/XLR 830	2940	85	15000	3250	25	A	17208
			F36W/835	CVG/XLR 835	3450	85	15000	3250	25	A	17202
			F36W/840	CVG/XLR 840	4040	85	15000	3250	25	A	17209
58	5ft	1500	F58W/830	CVG/XLR 830	2940	85	15000	5050	25	A	12403
			F58W/835	CVG/XLR 835	3450	85	15000	5050	25	A	12405
			F58W/840	CVG/XLR 840	4040	85	15000	5050	25	A	12407
70	6ft	1800	F70W/830	CVG/XLR 830	2940	85	15000	6100	25	A	12421
			F70W/835	CVG/XLR 835	3450	85	15000	6100	25	A	12423
			F70W/840	CVG/XLR 840	4040	85	15000	6100	25	A	12424

Polylux XLR™ Cov-R-Guard Rated Average Life on HF Electronic gear : 20000 hrs  
 Polylux XLR™ Rated Average Life on HF Electronic gear : 20000 hrs

## T8 Special Colours

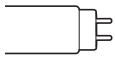

Watt	Length Ft	Length mm	Product Description	Product Type	CCT K	CRI Ra	Rated Average Life Hours	Initial lumens at 25°C	Pack Qty	EE Class	Product Code
T8 (∅ 26mm – 1")											
15	18in	450	F15W/AR/FR	Fresh Aqua	5000	-	9000	400	10	B	16977
			F15W/AR/FS	Fresh & Salt Aqua	9000+	-	9000	700	10	B	16965
			F15W/AR/SA	Salt Water	9000+	-	7500	210	10	B	16987
			F15W/AR/REP	Reptile	6400	82	7500	400	10	B	17002
18	2ft	600	F18W/AR/FR	Fresh Aqua	5000	-	7500	600	10	B	16979
			F18W/AR/FS	Fresh & Salt Aqua	9000+	-	15000	950	10	B	16966
			F18W/AR/SA	Salt Water	9000+	-	7500	270	10	B	16988
			F18W/AR/REP	Reptile	6400	82	7500	550	10	B	17003
25	2.5ft	750	F25W/AR/FR	Fresh Aqua	5000	-	7500	805	10	B	16980
			F25W/AR/FS	Fresh & Salt Aqua	9000+	-	15000	1350	10	B	16968
			F25W/AR/SA	Salt Water	9000+	-	7500	430	10	B	16991
30	3ft	900	F30W/AR/FR	Fresh Aqua	5000	-	7500	1035	10	B	16981
			F30W/AR/FS	Fresh & Salt Aqua	9000+	-	15000	1700	10	B	16969
			F30W/AR/SA	Salt Water	9000+	-	7500	540	10	B	16992
			F30W/AR/REP	Reptile	6400	82	7500	1100	10	B	17004
36	4ft	1200	F36W/AR/FR	Fresh Aqua	5000	-	7500	1425	10	B	16982
			F36W/AR/FS	Fresh & Salt Aqua	9000+	-	15000	2350	10	B	16970
			F36W/AR/SA	Salt Water	9000+	-	7500	700	10	B	16995
			F36W/AR/REP	Reptile	6400	82	7500	1250	10	B	17006
38	3.5ft	1050	F38W/AR/FR	Fresh Aqua	5000	-	7500	1320	10	B	16984
			F38W/AR/FS	Fresh & Salt Aqua	9000+	-	15000	2200	10	B	16971
			F38W/AR/SA	Salt Water	9000+	-	7500	650	10	B	16999
58	5ft	1500	F58W/AR/FR	Fresh Aqua	5000	-	7500	2225	10	B	16985
			F58W/AR/FS	Fresh & Salt Aqua	9000+	-	15000	3750	10	B	16972
			F58W/AR/SA	Salt Water	9000+	-	7500	1100	10	B	17000



## T12 Polylux

Watt	Length Ft	Length mm	Product Description	Product Type	CCT K	CRI Ra	Rated Average Life Hours	Initial lumens	Pack Qty	EE Class	Product Code
T12 (Ø 38mm - 111/2")											
40	4ft	1200	F40/840	Polylux 840	4040	80+	12000	6550	25	B	10572
75	6ft	1800	F75W/840	Polylux 840	4040	80+	12000	6550	25	B	43662
85	8ft	2400	F85W/840	Polylux 840	4040	80+	12000	7900	25	B	30642
100	8ft	2400	F100W/830	Polylux 830	2940	80+	12000	9100	25	B	43665

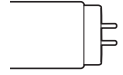

## T12 Rapid Start

Watt	Length Ft	Length mm	Product Description	Product Type	CCT K	CRI Ra	Rated Average Life Hours	Initial lumens	Pack Qty	EE Class	Product Code
T12 (Ø 38mm - 111/2")											
20	2ft	600	F20W/33/RS	3 Cool White	4040	58	9000	1150	25	B	29758
20			F20W/33/IRS/RS GE 1/25	33 Cool White	4040	58	9000	1150	25	B	39929
20			F20W/54/IRS/RS GE 1/25	54 Daylight	6400	76	9000	950	25	B	39945
20			F20W T12 54 RS GE 1/25	54 Daylight	6400	76	9000	950	25	B	93371
40	4ft	1200	F40W/33/RS	33 Cool White	4040	58	9000	2950	25	B	29775
40			F40W/29/RS	29 Warm White	2940	51	9000	2950	25	B	29776
40			F40W/33/IRS/RS GE 1/25	33 Cool White	4040	58	9000	2950	25	B	39943
40			F40W/54/IRS/RS GE 1/25	54 Daylight	6400	76	9000	2450	25	B	39944
40			F40W T12 54 RS GE 1/25	54 Daylight	6400	76	9000	2450	25	B	93372
65	5ft	1500	T12F65W/33/RS	33 Cool White	4040	58	9000	4750	25	B	29791
65			F65W/33/IRS/RS GE 1/25	33 Cool White	4040	58	9000	4750	25	B	39941

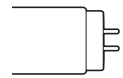

## T12 Standard Halophosphate

Watt	Length Ft	Length mm	Product Description	Colour Type	CCT K	CRI Ra	Rated Average Life Hours	Initial lumens at 25°C	Pack Qty	EE Class	Product Code
T12 (Ø 38mm - 111/2")											
20	2ft	600	F20W/29	Warm White	2940	51	9000	1150	25	B	29747
			F20W/35	White	3450	54	9000	1150	25	B	29748
			F20W/33	Cool White	4040	58	9000	1150	25	B	29746
			F20W/54	Daylight	6400	76	9000	950	25	B	29750
40	2ft	600	F40W2/35	White	3450	54	9000	1850	25	B	29762
40	4ft	1200	F40W/29	Warm White	2940	51	9000	2950	25	B	29767
			F40W/35	White	3450	54	9000	2950	25	B	29769
			F40W/33	Cool White	4040	58	9000	2950	25	B	29765
			F40W/25	Natural White	4000	70	9000	2500	25	B	29770
			F40W/54	Daylight	6400	76	9000	2450	25	B	29771
65	5ft	1500	F65W/29	Warm White	2940	51	9000	4750	25	B	29780
			F65W/35	White	3450	54	9000	4750	25	B	27646
			F65W/33	Cool White	4040	58	9000	4750	25	B	29779
			F65W/25	Natural	4000	70	9000	4000	25	B	29783
			F65W/54	Daylight	6400	76	9000	3900	25	B	29784
75	6ft	1800	F75W/29	Warm White	2940	51	9000	5750	25	B	43648
			F75W/35	White	3450	54	9000	5750	25	B	43649
			F75W/33	Cool White	4040	58	9000	5700	25	B	43647
85	8ft	2400	F85W/35	White	3450	54	9000	7100	25	B	31244
100	8ft	2400	F100W/35	White	3450	54	9000	8300	25	B	43654
			F100W/33	Cool White	4040	58	9000	8100	25	B	43655
125	8ft	2400	F125W/35	White	3450	54	9000	9200	25	B	43657
			F125W/54	Daylight	6500	76	9000	7500	25	B	43659

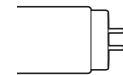

# Fluorescent lamps

## T12 Blacklight Blue

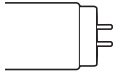

Watt	Length Ft	Length mm	Product Description	Colour Type	Spectral Peak	Irradiance nW/cm <sup>2</sup>	Rated Average Life Hours	Initial lumens at 25°C	Pack Qty	EE Class	Product Code
T12 (Ø 38mm - 111/2")											
20		600	F20W/BLB	Blacklight Blue	-	-	9000	-	6	-	34747
40		1200	F40W/BLB	Blacklight Blue	-	-	20000	-	6	-	25618

## T12 HO and VHO

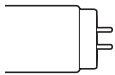

Watt	Length Ft	Length mm	Product Description	Colour Type	Spectral Peak	Irradiance nW/cm <sup>2</sup>	Rated Average Life Hours	Initial lumens at 25°C	Pack Qty	EE Class	Product Code
T12 (Ø 38mm - 111/2")											
110	96in	2400	F96T12/CW/HO	Cool White	4100	60	12000	8900	15	-	12540
215	96in	2400	F96T12/CW/1500	Cool White	4100	60	10000	13500	15	-	13781

## T12 Slimline™

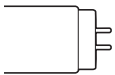

Watt	Length Ft	Length mm	Product Description	Colour Type	Spectral Peak	Irradiance nW/cm <sup>2</sup>	Rated Average Life Hours	Initial lumens at 25°C	Pack Qty	EE Class	Product Code
T12 (Ø 38mm - 111/2")											
75	96in	2400	F96T12/CW	Cool White	4150	60	12000	6150	15	-	25619

## T17 Power Groove® Rapid Start

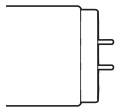

Watt	Length Ft	Length mm	Product Description	Colour Type	Spectral Peak	Irradiance nW/cm <sup>2</sup>	Rated Average Life Hours	Initial lumens at 25°C	Pack Qty	EE Class	Product Code
T17 (Ø 54mm - 211/8")											
215	96in	2400	F96PG17/CW	Cool White	4150	60	10000	14000	8	-	11009

## Circline™

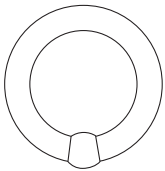

Watt	Length Ft	Length mm	Product Description	Colour Type	CCT K	CRI Ra	Rated Average Life Hours	Initial lumens at 25°C	Pack Qty	EE Class	Product Code
T9 (Ø 34.1mm - 111/8")											
22		209.5	FC8T9/D	Daylight	6400	75	5000	875	12	B	10454
			FC8T9/CW	Cool White	4040	58	5000	1000	12	B	10455
32		311.2	FC12T9/CW	Cool White	4040	62	5000	1825	12	B	10462
			FC12T9/D	Daylight	6400	75	5000	1550	12	B	10456
40		412.6	FC16T9/WW	Warm White	3000	51	5000	2800	12	B	35275
			FC16T9/CW	Cool White	4040	62	5000	2700	12	B	10474
			FC16T9/D	Daylight	6400	75	5000	2500	12	B	10508
60		412.6	FC1660/WW	Warm White	3000	51	12000	3700	12	B	29886

## Mod-U-Line™

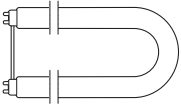

Watt	Length Ft	Length mm	Product Description	Colour Type	CCT K	CRI Ra	Rated Average Life Hours	Initial lumens at 25°C	Pack Qty	EE Class	Product Code
T8 (Ø 38mm - 111/2")											
40		525	F40UT8/835	Polylux 835	3450	80+	7500	3250	20	A	29904
			F40UT8/29	Warm White	2940	51	7500	2875	20	B	29888
			F40UT8/35	White	3450	54	7500	2875	20	B	29891
			F40UT8/33	Cool White	4040	58	7500	2875	20	B	29892

## Starters



Order Code	Product Description	Pack Qty	Product Code
155/200	15/22W 110V single or 220/240V twin	250 (10 x 25)	36711
155/200		2000	36714
155/500	4/65W universal 220/240V	250 (10 x 25)	36536
155/500		2000	36537
155/800	75/125W 240V	250 (10 x 25)	37864
155/801	70/100W 240V	250 (10 x 25)	37975
155/801		2000	37974



## Fluorescent lamps

Fluorescent lamps provide a much more dispersed light than 'point' sources such as incandescent, halogen or discharge lamps. This quality, along with their outstanding energy efficiency, make them ideally suited for lighting large open areas such as offices and industrial buildings. Standard fluorescent lamps use halophosphate lamp coatings. These lamps are used where low initial cost is the most important factor. However, higher performance lamps using triphosphor coatings, such as GE's PolyLux XLR™ lamps, are now increasingly being used as they provide significant energy savings.

### The effects of switching on+off

Frequent switching on+off of fluorescent lamps can reduce their operational life. The graph, Fig 1 below, shows the effect on a lamp's life of different switching cycles. Although a lamp that is only switched on and off rarely will last longer, light output does fall in the latter stage of a lamp's life.

### The effects of temperature change

Fluorescent lamps are designed to produce their optimum light output at an ambient temperature of 25°C. However, when installed in a lamp fitting, the temperature of the air surrounding a lamp can change and affect the light output of the lamp. The effects of changes in ambient temperature for a typical lamp are shown in the graph, Fig 2 below.

### Using electronic ballasts

The efficiency of fluorescent lamps can be improved by increasing the frequency of the mains voltage supplied to them. Electronic ballasts and controls can be used to increase the normal mains frequency of 50/60Hz to 25/30KHz improving lamp efficiency by approximately 10%. Electronic ballasts also consume less power than conventional ballasts and when combined with other efficiency benefits, electronic ballasts can achieve power savings of around 20% compared to conventional 50/60Hz systems with the same light output levels.

### Light-output data

The lumen output figures quoted are measured at 25°C in accordance with EN60081 and EN60901.

### Caution notice

Handle and install all fluorescent lamps with care. Turn off power before installing lamps.

**Fig 1** Effect on life of different switching cycles

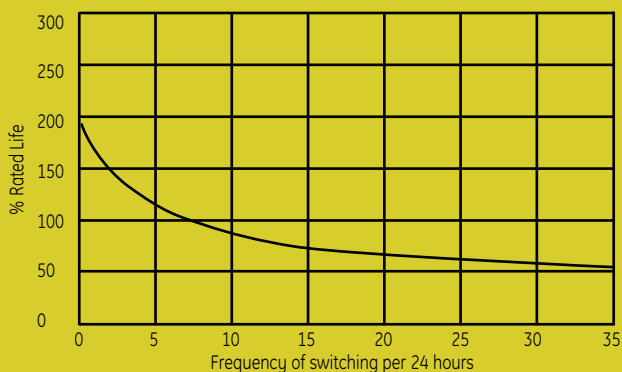

**Fig 2** light output relative to ambient temperature

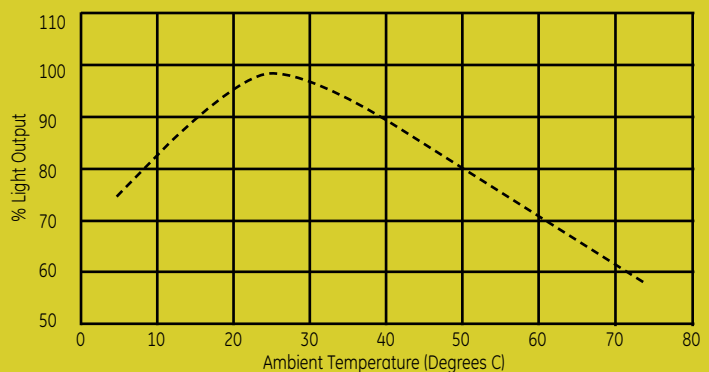

## Compact fluorescent lamps

GE's compact fluorescent lamps provide more light and generate less heat, converting up to 25% of the electricity they use into light.

Incandescent lamps convert 95% of electricity into heat, producing only 5% into light. As CFLs use less energy you pay less for your lighting. They also last up to 20 times longer than incandescent lamps, so you spend less on maintenance.

While you save on cost with GE compact fluorescents, nothing is lost in quality. Colours are reproduced accurately and flicker-free light output is maintained for the whole of the lamp's life.



## Content

CFL selection guide	76
Biax™ L 4 pin	88
Cinema High Lumen Biax™	88
Biax™ S 2pin	88
Biax™ S/E 4pin	89
Biax™ D 2pin	89
Biax™ D/E 4pin	89
Biax™ T 2pin	90
Biax™ T/E 4pin	90
Biax™ T/E LongLast™	90
Biax™ Q/E LongLast™	90
Biax™ Q/E Ballast	90
Biax™ 2D™ 2 pin	92
2D Watt-Miser™ 2pin	92
2D Watt-Miser™ 4pin	92
Biax™ 2D™ with integral control gear	92
Electronic Biax™ Extra Mini Hex T3	93
Electronic Biax™ Extra Mini Oct T3	93
Electronic Eco T3	93
Electronic Mini Eco T3	94
Electronic Eco T4	94
Electronic Spiral T2	95
Electronic Spiral T3	95
Electronic Décor GLS T2	95
Electronic GLS T3	96
Electronic Candle T2	96
Electronic Candle, Twisted Candle, Bent-Tip Candle T3	96
Electronic Reflector T2	96
Electronic Reflector T3	96
Electronic GU10 T2	97
Electronic Reflector PAR 38	97
Electronic Spherical T2	97
Electronic Globe	97
Electronic Sensor	97
Genura™ R80	97
General information	98











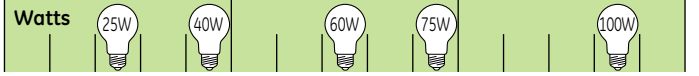



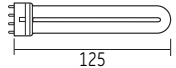



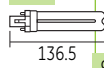
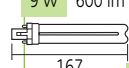
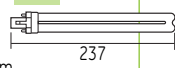



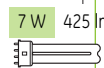
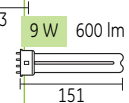





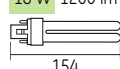

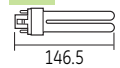

# Compact fluorescent lamps

## GE Biax™ Lamps

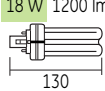
Lumens 500 1000 1500

Nearest incandescent equivalent wattage

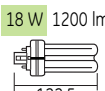

	18W	24W	34W	36W	40W	55W	80W		500	1000	1500
 <p><b>Biax™ L - 4 pin</b> 18W 24W 34W 36W 40W 55W 80W</p>  <p>43.9 mm</p>											<p>18 W 1250 lm</p> 
 <p><b>Biax™ S - 2 pin</b> 5W 7W 9W 11W</p>  <p>32.5 mm</p>								<p>5 W 265 lm</p> 	<p>7 W 425 lm</p> 	<p>9 W 600 lm</p> 	<p>11 W 900 lm</p> 
 <p><b>Biax™ S/E - 4 pin</b> 5W 7W 9W 11W</p>  <p>37.5 mm</p>								<p>5 W 265 lm</p> 	<p>7 W 425 lm</p> 	<p>9 W 600 lm</p> 	<p>11 W 900 lm</p> 
 <p><b>Biax™ D - 2 pin</b> 10W 13W 18W 26W</p>  <p>35 mm</p>									<p>10 W 600 lm</p> 	<p>13 W 900 lm</p> 	<p>18 W 1200 lm</p> 
 <p><b>Biax™ D/E - 4 pin</b> 10W 13W 18W 26W</p>  <p>35 mm</p>									<p>10 W 600 lm</p> 	<p>13 W 900 lm</p> 	<p>18 W 1200 lm</p> 
 <p><b>Biax™ T - 2 pin</b> 13W 18W 26W</p>  <p>49 mm</p>										<p>13 W 900 lm</p> 	<p>18 W 1200 lm</p> 
 <p><b>Biax™ T/E - 4 pin</b> 13W 18W 26W 32W 42W</p>  <p>49 mm</p>										<p>13 W 900 lm</p> 	<p>18 W 1200 lm</p> 
 <p><b>Biax™ Q/E - LongLast-Amalgam- 4pin</b> 57W 70W</p>  <p>58 mm</p>											

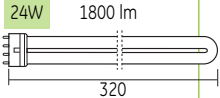
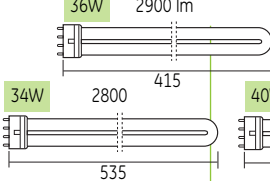
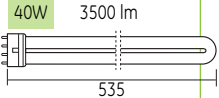
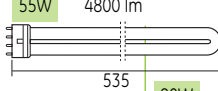
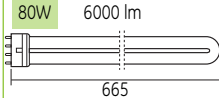
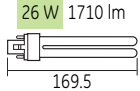
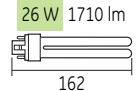
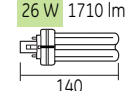
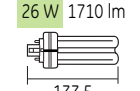
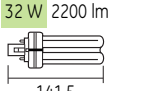
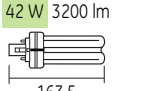
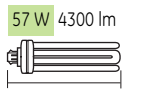
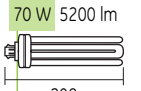

# Compact Fluorescent Selection Guide

150W		200W		300W	
 <p>24W 1800 lm 320</p>		 <p>36W 2900 lm 2800 415 535</p>	 <p>40W 3500 lm 535</p>	 <p>55W 4800 lm 535</p>	 <p>80W 6000 lm 665</p>
 <p>26 W 1710 lm 169.5</p>					
 <p>26 W 1710 lm 162</p>					
 <p>26 W 1710 lm 140</p>					
 <p>26 W 1710 lm 133.5</p>	 <p>32 W 2200 lm 141.5</p>		 <p>42 W 3200 lm 163.5</p>		
				 <p>57 W 4300 lm 178</p>	 <p>70 W 5200 lm 208</p>

# Compact fluorescent lamps

## GE Biax™ 2D™ Lamps



### Biax™ 2D™ - 2 pin

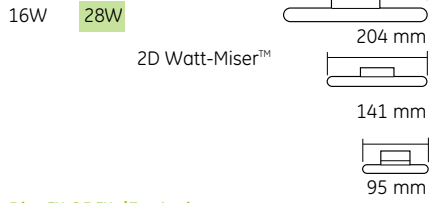

### Biax™ 2D™ /E - 4 pin

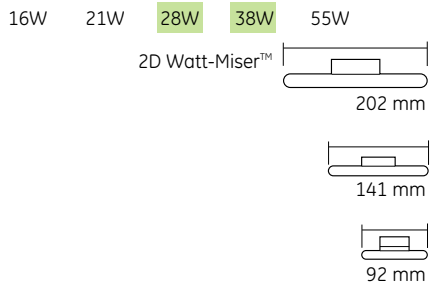

### Biax™ 2D™ Lamp with integral control gear



Lumens	500		1000		1500
Watts	25W	40W	60W	75W	100W

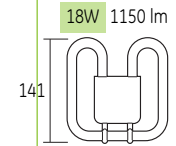
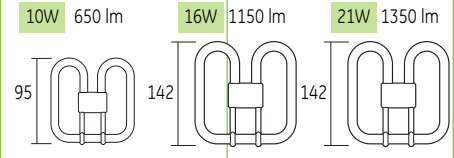
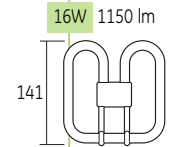

# Compact Fluorescent Selection Guide

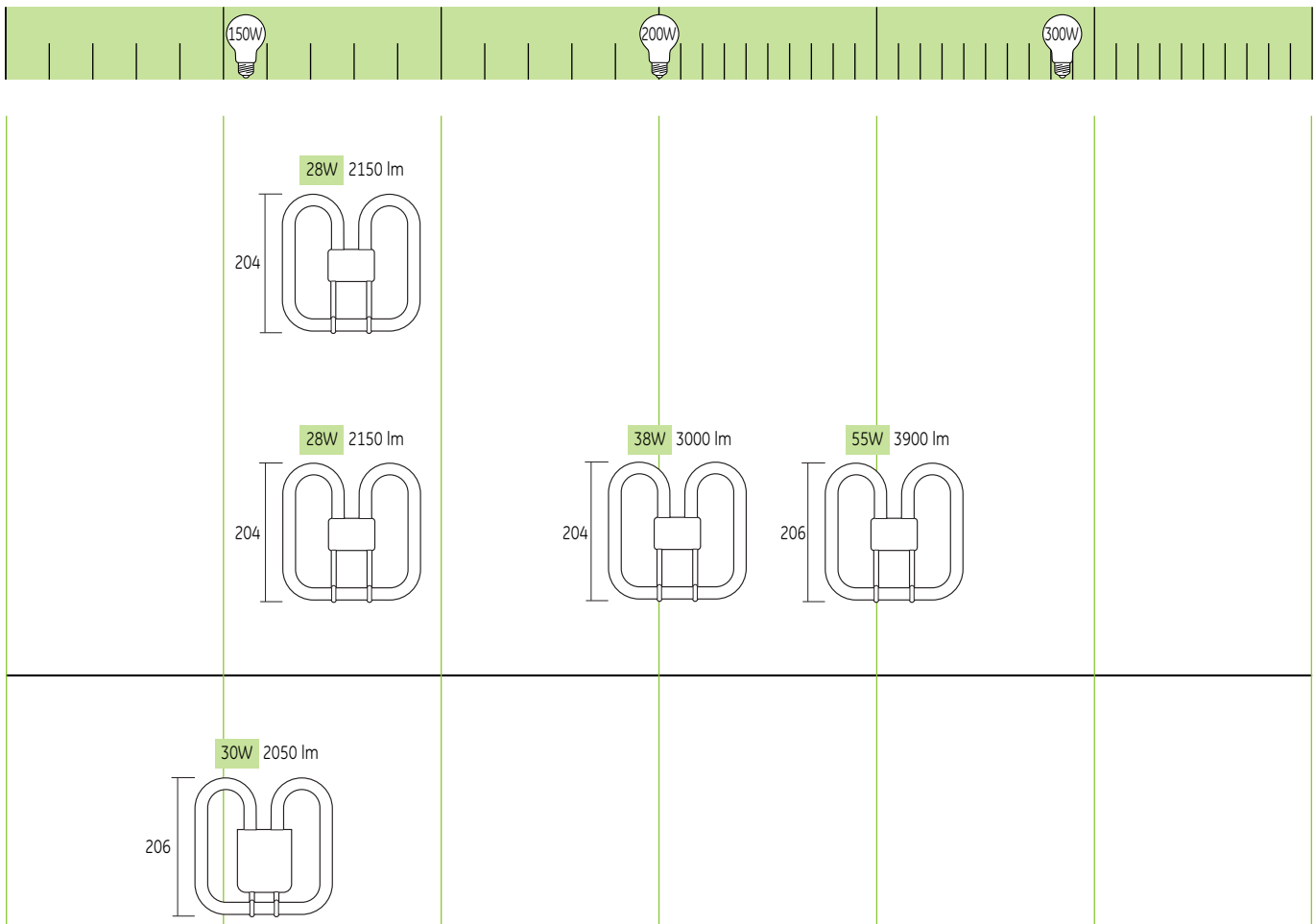

# Compact fluorescent lamps

## GE Electronic Biax™ Lamps

Life

6000

Nearest incandescent equivalent wattage

Watts



### Extra Mini - 15,000hours

220/240V	Wattage	Base	Socket	Shape	Code
	9W	E14	E27	B22	TBX
	11W	E14	E27	B22	TBX
	15W		E27	B22	TBX
	20W		E27	B22	TBX
	23W		E27	B22	QBX



### Electronic Eco T3 - 10,000hours

220/240V	Wattage	Base	Socket	Shape	Code
	9W	E14	E27	B22	TBX
	11W	E14	E27	B22	TBX
	15W		E27	B22	TBX
	20W		E27	B22	TBX
	23W		E27	B22	QBX



### Electronic Mini Eco T3 - 6,000hours

220/240V	Wattage	Base	Socket	Shape	Code
	9W	E14	E27	B22	TBX
	11W	E14	E27	B22	TBX
	15W		E27	B22	TBX
	20W		E27	B22	TBX
	23W		E27	B22	QBX







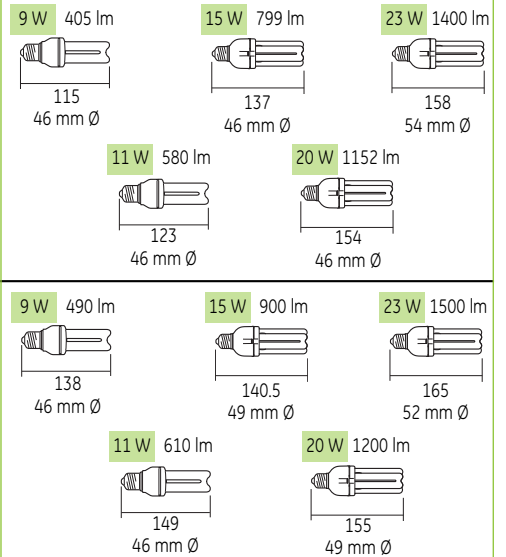





### Electronic Eco T4 - 6,000hours

220/240V	Wattage	Base	Socket	Shape	Code
	9W	E14	E27	B22	DBX
	11W	E14	E27	B22	DBX
	15W		E27	B22	TBX
	20W		E27	B22	TBX
	23W		E27	B22	TBX



# Compact Fluorescent Selection Guide

8000				10000				12000				15000				
40W	60W	75W	100W	40W	60W	75W	100W	40W	60W	75W	100W	40W	60W	75W	100W	120W
								<p>9 W 480 lm    11 W 600 lm    20 W 1200 lm</p>    <p>15 W 900 lm    23 W 1500 lm</p>  								
				<p>9 W 405 lm    15 W 872 lm    23 W 1380 lm</p>    <p>11 W 640 lm    20 W 1152 lm</p>  												

# Compact fluorescent lamps

## GE Electronic Biax™ Lamps

Life

6000

Nearest incandescent equivalent wattage Watts



### Electronic Spiral Mini-8,000hours

220/240V	8W	E14	E27	B22
	12W	E14	E27	B22
	15W	E14	E27	B22
	20W		E27	B22
	23W		E27	B22



### Electronic Spiral T3

220/240V	11W	E27	B22
	20W	E27	B22

11 W 580 lm



20 W 1152 lm



### Electronic Decor T2 GLS types

220/240V	8W	E14	E27	B22
	12W	E14	E27	B22
	15W	E14	E27	B22

8 W 360 lm



12 W 600 lm



15 W 825 lm



### Electronic GLS T3

220/240V	7W	E14	E27	B22
	9W	E14	E27	B22
	11W	E14	E27	B22
	15W		E27	B22
	20W		E27	B22

7 W 286 lm

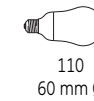

11 W 580 lm



20 W 1152 lm

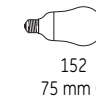

9 W 405 lm



15 W 799 lm



### Electronic Candle T2

220/240V	5W	E14	E27	B22
	7W	E14	E27	B22

5 W 180 lm

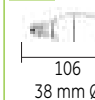

7 W 286 lm

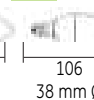

### Electronic Candle T3

220/240V	5W	E14	
	7W	E14	
	9W	E27	B22

5 W 117 lm

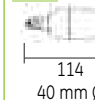

7 W 286 lm

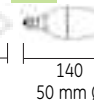

9 W 405 lm

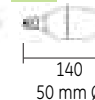

### Electronic Twisted Candle

220/240V	5W	E14	
	7W	E14	

5 W 177 lm







7 W 286 lm

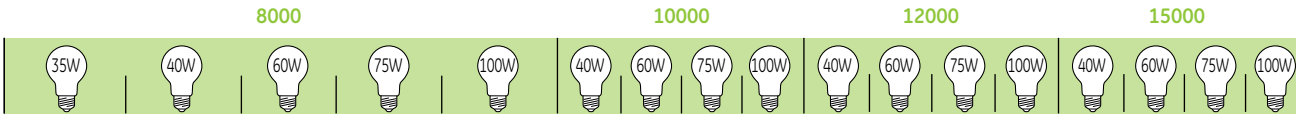

# Compact Fluorescent Selection Guide



<p>7 W 286 lm    9 W 405 lm</p>  <p>110 60 mm Ø</p>  <p>116 60 mm Ø</p> <p>11 W 580 lm    15 W 799 lm    20 W 1152 lm</p>  <p>124 60 mm Ø</p>  <p>135 60 mm Ø</p>  <p>152 60 mm Ø</p>			

# Compact fluorescent lamps











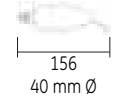



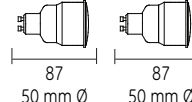

## GE Electronic Biax™ Lamps

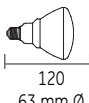
Life

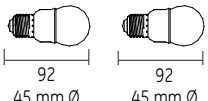
6000

Nearest incandescent equivalent wattage Watts

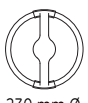

	<p><b>Electronic Bent-tip Candle T3</b> 220/240V 7W E14</p>	<p>7 W 286 lm 156 40 mm Ø</p> 
	<p><b>Electronic Reflector T2</b> 220/240V 7W E14 E27 B22 11W E14 E27 B22</p>	<p>7 W 11 W 92 105 R50 mm Ø R63 mm Ø</p> 
	<p><b>Electronic Reflector</b> 220/240V 7W E14 9W E14 11W E27</p>	<p>7 W 117 lm 9 W 286 lm 11 W 405 lm 112 114 123 R50 mm Ø R63 mm Ø R63 mm Ø</p> 
	<p><b>Electronic GU10 T2</b> 220/240V 7W GU10 9W GU10</p>	<p>7 W 9 W 87 87 50 mm Ø 50 mm Ø</p> 
	<p><b>Electronic Reflector PAR38</b> 220/240V 23W E27 B22</p>	<p>23 W 120 63 mm Ø</p> 
	<p><b>Electronic Spherical T2</b> 220/240V 5W E14 E27 B22 7W E14 E27 B22</p>	<p>5 W 180 lm 7 W 180 lm 92 92 45 mm Ø 45 mm Ø</p> 
	<p><b>Electronic Sensor</b> 220/240V 15W E27 B22</p>	<p>15 W 800 lm 92 45 mm Ø</p> 
	<p><b>Electronic Circlelite T5</b> 220/240V 22W E27</p>	<p>22 W 1800 lm 230 mm Ø</p> 
	<p><b>Electronic Globe</b> 220/240V 22W E27</p>	
	<p><b>Genura™ R80</b> 220/240V 22W E27</p>	



# Compact Fluorescent Selection Guide

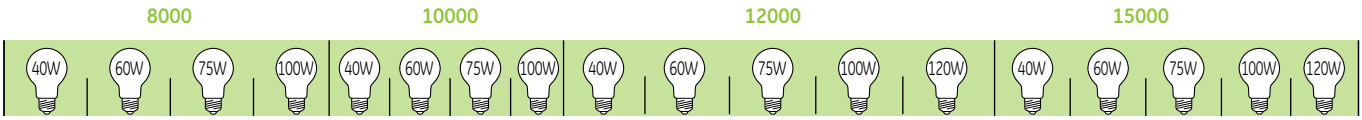

<p>11 W 550 lm</p>	<p>15 W 750 lm</p>	<p>20 W 1050 lm    23 W 1250 lm</p>	
			<p>23 W 1100 lm</p>

# Compact fluorescent lamps

## Product identification

The following glossary of terms and descriptions can help you when checking compact fluorescent lamp specifications and explains how to use the product codes when ordering products. Within each product line, lamps are divided into families - within families, lamps are listed by wattage.

**Lamp:**  
Lamp description followed by base description

**Length:**  
Expressed in feet and mm

**CRI Ra:**  
Colour rendering index, the higher the number (1-100) the more natural the lit subject appears

**Product Code:**  
It is important to use this code when ordering to ensure that you receive the exact product you require

**Biax™ L – 4 pin**

**Product Description:**  
The lamp's identification code

**Initial Lumens:**  
Light output after the initial 100 hours of operation

**Pack Quantity:**  
The number of lamps in one box

Watts	Length mm	Cap	Product Description	CCT K	CRI Ra	Initial lumens	Rated Average Life Hours	Pack Qty	EE Class	Product Code
18	228	2G11	F18BX/827	2700	82	1250	10000	25	B	30639
			F18BX/830	3000	82	1250	10000	25	B	29223
			F18BX/835	3500	82	1250	10000	25	B	30613
			F18BX/840	4000	82	1250	10000	25	B	30614

**Watts:**  
Energy used. To find actual energy used (kWh) multiply power (watts shown) x hours of use divided by 1000

**Cap:**  
The type of cap fitted

**CCT K:**  
Colour temperature – Kelvin. The visual warmth or coolness of the light. The higher the number the whiter or cooler the light appears

**Energy Efficiency Class:**  
Energy saving code

**F18/BX/840**

Identifies lamp as fluorescent

Colour temperature code

Identifies lamp wattage

Identifies product type

**Rated Average Life:**  
The point in time when 50% of installed lamps are still burning



# Compact fluorescent lamps

GE Biax™ lamps offer up to 80% energy savings compared to equivalent incandescent lamps and last up to 10 times longer.

## Biax™ L

- Stretched full length source with 4 pin base designed for 600mm square light fittings
- Replaces linear fluorescents twice the length
- Single-ended for simpler installation
- Round loop construction means no dark ends
- High surface brightness for improved optical control
- Polyflux phosphors allow matching with other fluorescents



Biax™ L

## Biax™ S & S/E

- Biax™ S with 2 pin base and extra compact design to suit reduced size fittings
- Biax™ S/E with 4 pin base and external starter/controls for use with electronic control gear and dimming and emergency lighting applications
- Five times more efficient than GLS lamps
- Nine times less maintenance compared to GLS lamps
- High colour rendering – matching the colour temperatures of incandescents



Biax™ S & S/E

## Biax™ D & D/E

- 2 pin or 4 pin formats
- Light quality and colour performance to match other fluorescent
- High colour reproduction performance, providing rich, vibrant colours
- Wide range of wattages to suit all applications



Biax™ D & D/E

## Biax™ T & T/E

- High colour reproduction performance, providing rich, vibrant colours
- Consistent high light output, irrespective of ambient temperature and the angle of installation
- Slim 49mm hexagonal base



Biax™ T & T/E

## Biax™ Q/E

- High Lumen output with compact fluorescent and amalgam technology: 4200/5200 lm.
- Small size – eight legged
- HF ballast operation
- Instant on quick warm up, hot restrike
- Wide colour range
- Low cost white light solution



Biax™ Q/E

## Biax 2D

- Compact fluorescent tubes formed into a "2D" shape
- Energy saving 2D Watt-Miser™ types are available
- High luminous efficacy
- Excellent colour rendering - CRI Ra 82
- Compatible with existing ballasts and fittings
- Up to 15,000 hours life time



Biax™ 2D

# Compact fluorescent lamps

## Biax™ – Plug-In

### Biax™ L – 4 pin External Starter Required

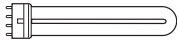

Watts	Reference Length mm	Length with contact pin	Cap	Product Description	CCT K	CRI Ra	Initial lumens	Rated Average Life Hours	Pack Qty	EE Class	Volts	I (A)	Product Code
18	225	231.8	2G11	F18BX/827	2700	82	1250	10000	25	B	61	0.37	41087
				F18BX/830	3000	82	1250	10000	25	B	61	0.37	41088
				F18BX/835	3500	82	1250	10000	25	B	61	0.37	41089
				F18BX/840	4000	82	1250	10000	25	B	61	0.37	41090
24	320	326.8	2G11	F24BX/827	2700	82	1800	10000	25	B	91	0.34	41128
				F24BX/830	3000	82	1800	10000	25	B	91	0.34	41134
				F24BX/835	3500	82	1800	10000	25	B	91	0.34	41145
				F24BX/840	4000	82	1800	10000	25	B	91	0.34	41155
34*	535	541.8	2G11	F34BX/830	3000	82	2800	10000	25	A	120	0.41	41163
				F34BX/835	3500	82	2800	10000	25	A	120	0.41	41166
				F34BX/840	4000	82	2800	10000	25	A	120	0.41	41167
36	415	421.8	2G11	F36BX/827	2700	82	2900	10000	25	A	112	0.43	41307
				F36BX/830	3000	82	2900	10000	25	A	112	0.43	41168
				F36BX/835	3500	82	2900	10000	25	A	112	0.43	41169
				F36BX/840	4000	82	2900	10000	25	A	112	0.43	41170
40***	535	541.8	2G11	F40BX/830	3000	82	3500**	20000	25	A	126	0.32	41171
				F40BX/835	3500	82	3500	20000	25	A	126	0.32	41172
				F40BX/840	4000	82	3500	20000	25	A	126	0.32	41173
55***	535	541.8	2G11	F55BX/830	3000	82	4800	20000	25	A	100	0.55	41174
				F55BX/835	3500	82	4800	20000	25	A	100	0.55	41260
				F55BX/840	4000	82	4800	20000	25	A	100	0.55	41298
80***	565		2G11	F80BX/830	3000	82	6000	20000	25	A	145	0.55	88726
				F80BX/835	3500	82	6000	20000	25	A	145	0.55	88727
				F80BX/840	4000	82	6000	20000	25	A	145	0.55	88728

\* Use with conventional ballast and electronic starter switch or fully electronic unit \*\* Lumens on HF gear, Lumens on approved conventional circuit 3360  
 \*\*\* Use on HF gear only

### Cinema High Lumen Biax Lamps



Watts	Length with contact pin	Product Description	Description	CCTK	CRI Ra	Initial Lumens	Rated Average Life Hours	Pack Qty	Volts	I (A)	Product Code
55**		F55BX/CINEMA32	Indoor				10000	10	100	0.55	41869
55**		F55BX/CINEMA56	Daylight				10000	10	100	0.55	41873

\* Use with conventional ballast and electronic starter switch or fully electronic unit  
 \*\* For High-Frequency operation

### Biax™ S – 2 pin Internal Starter

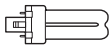

Watts	Length mm	Cap	Product Description	CCT K	CRI Ra	Initial lumens	Rated Average Life Hours	Pack Qty	EE Class	Volts	I (A)	Product Code
5	107.5	G23	F5BX/827	2700	82	265	10000	10	B	35	0.18	37654
			F5BX/840	4000	82	265	10000	10	B	35	0.18	37661
7	136.5	G23	F7BX/827	2700	82	425	10000	10	A	47	0.175	37846
			F7BX/830	3000	82	425	10000	10	A	47	0.175	38930
			F7BX/835	3500	82	425	10000	10	A	47	0.175	37659
			F7BX/840	4000	82	425	10000	10	A	47	0.175	37660
			F7BX/865	6500	82	425	10000	10	A	47	0.175	38984
9	167	G23	F9BX/827	2700	82	600	10000	10	A	60	0.17	37651
			F9BX/830	3000	82	600	10000	10	A	60	0.17	38929
			F9BX/835	3500	82	600	10000	10	A	60	0.17	37652
			F9BX/840	4000	82	600	10000	10	A	60	0.17	37653
			F9BX/865	6500	82	600	10000	10	A	60	0.17	38985
11	237	G23	F11BX/827	2700	82	900	10000	10	A	91	0.155	37663
			F11BX/830	3000	82	900	10000	10	A	91	0.155	38928
			F11BX/835	3500	82	900	10000	10	A	91	0.155	37666
			F11BX/840	4000	82	900	10000	10	A	91	0.155	37664
			F11BX/865	6500	82	900	10000	10	A	91	0.155	38986



### Biax™ S/E – 4 pin External Starter Required

Watts	Length mm	Cap	Product Description	CCT K	CRI Ra	Initial lumens	Rated Average Life Hours	Pack Qty	EE Class	Volts	I (A)	Product Code
5	92	2G7	F5BX/827/4P	2700	82	265	10000	10	B	35	0.18	37714
			F5BX/840/4P	4000	82	265	10000	10	B	35	0.18	37715
7	121	2G7	F7BX/827/4P	2700	82	425	10000	10	A	47	0.175	37658
			F7BX/840/4P	4000	82	425	10000	10	A	47	0.175	37716
9	151	2G7	F9BX/827/4P	2700	82	600	10000	10	A	60	0.17	37710
			F9BX/840/4P	4000	82	600	10000	10	A	60	0.17	37711
11	222	2G7	F11BX/827/4P	2700	82	900	10000	10	A	91	0.155	37717
			F11BX/840/4P	4000	82	900	10000	10	A	91	0.155	37713
			F11BX/865/4P	6500	82	900	10000	10	A	91	0.155	12603

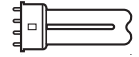

### Biax™ D – 2 pin Internal Starter

10	108.5	G24d-1	F10DBX/827	2700	82	600	10000	10	B	64	0.19	12872
			F10DBX/830	3000	82	600	10000	10	B	64	0.19	12874
			F10DBX/835	3500	82	600	10000	10	B	64	0.19	12875
			F10DBX/840	4000	82	600	10000	10	B	64	0.19	12876
			F10DBX/865	6500	82	600	10000	10	B	64	0.19	12997
13	133	G24d-1	F13DBX/827	2700	82	900	10000	10	A	91	0.175	18557
			F13DBX/830	3000	82	900	10000	10	A	91	0.175	12956
			F13DBX/835	3500	82	900	10000	10	A	91	0.175	18559
			F13DBX/840	4000	82	900	10000	10	A	91	0.175	20532
			F13DBX/865	6500	82	900	10000	10	A	91	0.175	13015
18	154	G24d-2	F18DBX/827	2700	82	1200	10000	10	B	100	0.22	12860
			F18DBX/830	3000	82	1200	10000	10	B	100	0.22	12861
			F18DBX/835	3500	82	1200	10000	10	B	100	0.22	12863
			F18DBX/840	4000	82	1200	10000	10	B	100	0.22	12864
			F18DBX/865	6500	82	1200	10000	10	B	100	0.22	13017
26	169.5	G24d-3	F26DBX/827	2700	82	1710	10000	10	B	105	0.325	35250
			F26DBX/830	3000	82	1710	10000	10	B	105	0.325	35237
			F26DBX/835	3500	82	1710	10000	10	B	105	0.325	35251
			F26DBX/840	4000	82	1710	10000	10	B	105	0.325	35252
			F26DBX/865	6500	82	1710	10000	10	B	105	0.325	35305

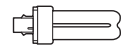

### Biax™ D/E – 4 pin External Starter Required

10	101	G24q-1	F10DBX/827/4P	2700	82	600	12000	10	B	64	0.19	30031
			F10DBX/830/4P	3000	82	600	12000	10	B	64	0.19	12877
			F10DBX/835/4P	3500	82	600	12000	10	B	64	0.19	30032
			F10DBX/840/4P	4000	82	600	12000	10	B	64	0.19	30034
13	125.5	G24q-1	F13DBX/827/4P	2700	82	900	12000	10	A	91	0.175	30035
			F13DBX/830/4P	3000	82	900	12000	10	A	91	0.175	10580
			F13DBX/835/4P	3500	82	900	12000	10	A	91	0.175	30037
			F13DBX/840/4P	4000	82	900	12000	10	A	91	0.175	30038
18	146.5	G24q-2	F18DBX/827/4P	2700	82	1200	12000	10	B	100	0.22	12865
			F18DBX/830/4P	3000	82	1200	12000	10	B	100	0.22	12866
			F18DBX/835/4P	3500	82	1200	12000	10	B	100	0.22	12869
			F18DBX/840/4P	4000	82	1200	12000	10	B	100	0.22	12870
26	162	G24q-3	F26DBX/827/4P	2700	82	1710	12000	10	B	105	0.325	35247
			F26DBX/830/4P	3000	82	1710	12000	10	B	105	0.325	35235
			F26DBX/835/4P	3500	82	1710	12000	10	B	105	0.325	35248
			F26DBX/840/4P	4000	82	1710	12000	10	B	105	0.325	35236



# Compact fluorescent lamps

## Biax™ – Plug-In

### Biax™ T-2 pin with Amalgam Internal Starter



Watts	Length mm	Cap	Product Description	CCT K	CRI Ra	Initial lumens	Rated Average Life Hours	Pack Qty	EE Class	Volts	I (A)	Product Code
13	115.5	GX24d-1	F13TBX/827/A	2700	82	900	10000	10	A	91	0.175	35940
			F13TBX/830/A	3000	82	900	10000	10	A	91	0.175	35966
			F13TBX/835/A	3500	82	900	10000	10	A	91	0.175	35943
18	130	GX24d-2	F13TBX/840/A	4000	82	900	10000	10	A	91	0.175	35941
			F18TBX/827/A	2700	82	1200	10000	10	B	100	0.22	35945
			F18TBX/830/A	3000	82	1200	10000	10	B	100	0.22	35944
26	140	GX24d-3	F18TBX/835/A	3500	82	1200	10000	10	B	100	0.22	35937
			F18TBX/840/A	4000	82	1200	10000	10	B	100	0.22	35939
			F18TBX/865/A	6500	82	1200	10000	10	B	100	0.22	35938
			F26TBX/827/A	2700	82	1710	10000	10	B	105	0.325	35959
			F26TBX/830/A	3000	82	1710	10000	10	B	105	0.325	35952
			F26TBX/835/A	3500	82	1710	10000	10	B	105	0.325	35963
			F26TBX/840/A	4000	82	1710	10000	10	B	105	0.325	35964
F26TBX/865/A	6500	82	1710	10000	10	B	105	0.325	35965			

### BIAX™ T - 2 pin with Electronic Starter



Watts	Cap	Product Description	CCT K	CRI Ra	Initial lumens	Rated Average Life Hours	Pack Qty	Product Code
26	GX24d-3	F26TBX/SPX41/840/2P ELECTRIC.START	4000	82	1710	10000	10	92702
26	GX24d-3	F26TBX/SPX30/830/2P ELECTRIC START	3000	82	1710	10000	10	92703

### Biax™ T/E – 4 pin with Amalgam External Starter Required



Watts	Length mm	Cap	Product Description	CCT K	CRI Ra	Initial lumens	Rated Average Life Hours	Pack Qty	EE Class	Volts	I (A)	Product Code
13	108	GX24q-1	F13TBX/827/A/4P	2700	82	900	12000	10	A	91	0.175	34391
			F13TBX/830/A/4P	3000	82	900	12000	10	A	91	0.175	34395
			F13TBX/835/A/4P	3500	82	900	12000	10	A	91	0.175	34400
			F13TBX/840/A/4P	4000	82	900	12000	10	A	91	0.175	34387
18	122.5	GX24q-2	F18TBX/827/A/4P	2700	82	1200	12000	10	B	100	0.22	34392
			F18TBX/830/A/4P	3000	82	1200	12000	10	B	100	0.22	34396
			F18TBX/835/A/4P	3500	82	1200	12000	10	B	100	0.22	34405
			F18TBX/840/A/4P	4000	82	1200	12000	10	B	100	0.22	34385
26	133.5	GX24q-3	F26TBX/827/A/4P	2700	82	1710	12000	10	B	105	0.325	34393
			F26TBX/830/A/4P	3000	82	1710	12000	10	B	105	0.325	34397
			F26TBX/835/A/4P	3500	82	1710	12000	10	B	105	0.325	34406
			F26TBX/840/A/4P	4000	82	1710	12000	10	B	105	0.325	34381
32	141.5	GX24q-3	F32TBX/827/A/4P	2700	82	2200	12000	10	B	100	0.32	39377
			F32TBX/830/A/4P	3000	82	2200	12000	10	B	100	0.32	39378
			F32TBX/835/A/4P	3500	82	2200	12000	10	B	100	0.32	39379
			F32TBX/840/A/4P	4000	82	2200	12000	10	B	100	0.32	39380
42	163.5	GX24q-4	F42TBX/827/A/4P/EOL	2700	82	3200	12000	10	B	135	0.32	46312
			F42TBX/830/A/4P/EOL	3000	82	3200	12000	10	B	135	0.32	46313
			F42TBX/835/A/4P/EOL	3500	82	3200	12000	10	B	135	0.32	46314
			F42TBX/840/A/4P/EOL	4000	82	3200	12000	10	B	135	0.32	46315

### Biax™ T/E – 4-pin LongLast

13	106.2	GX24q-1	F13TBX/827/A/4P/LL	2700	82	900	20000*	10	A			45801
13	106.2	GX24q-1	F13TBX/830/A/4P/LL	2700	82	900	20000*	10	A			45802
13	106.2	GX24q-1	F13TBX/835/A/4P/LL	2700	82	900	20000*	10	A			45804
13	106.2	GX24q-1	F13TBX/840/A/4P/LL	2700	82	900	20000*	10	A			45805
13	106.2	GX24q-1	F13TBX/850/A/4P/LL	2700	82	900	20000*	10	A			45806
26	130.7	GX24q-3	F26TBX/840/A/4P/LL	4000	82	1710	20000*	10	A	80	0.3	43925
32	138.7	GX24q-3	F32TBX/830/A/4P/LL	3000	82	2200	20000*	10	A	100	0.32	43928
32	138.7	GX24q-3	F32TBX/840/A/4P/LL	4000	82	2200	20000*	10	A	100	0.32	43930
42	163.2	GX24q-4	F42TBX/830/A/4P/LL	3000	82	3200	20000*	10	A	135	0.32	43933
42	163.2	GX24q-4	F42TBX/840/A/4P/LL	4000	82	3200	20000*	10	A	135	0.32	43935

\* 20000h life with 11 hour on / 1 hour off burning cycle with high frequency ballast,  
 \*\* 900/810 – Base Up/Base Down

### Biax™ Q/E – 4-pin LongLast



57	181	GX24q-5	F57QBX/827/A/4P/LL	2700	82	4300	20000*	10	A	155	0.32	45213
57	181	GX24q-5	F57QBX/830/A/4P/LL	3000	82	4300	20000*	10	A	155	0.32	45204
57	181	GX24q-5	F57QBX/835/A/4P/LL	3500	82	4300	20000*	10	A	155	0.32	45202
57	181	GX24q-5	F57QBX/840/A/4P/LL	4000	82	4300	20000*	10	A	155	0.32	45201
70	208	GX24q-6	F70QBX/827/A/4P/LL	2700	82	5200	20000*	10	A	199	0.32	45186
70	208	GX24q-6	F70QBX/830/A/4P/LL	3000	82	5200	20000*	10	A	199	0.32	45208
70	208	GX24q-6	F70QBX/835/A/4P/LL	3500	82	5200	20000*	10	A	199	0.32	45219
70	208	GX24q-6	F70QBX/840/A/4P/LL	4000	82	5200	20000*	10	A	199	0.32	45218

\* 20000h life with 11 hour on / 1 hour off burning cycle

### Biax™ Q/E Electronic Ballast

Nr of Lamps	Lamp Watts	Volts	Product Description	Initial Lumens	Lamp Power W	Lamp Efficacy lm/W	System Power W	System Efficacy lm/W	Colour Rendering Ra	Input Current A	Pack Qty	Product Code
1	57	220-240	BLS/E/1x57-70W/QBX	4300	56.0	77	60.5	71	82	0.28	0.25 12	13248
1	70	220-240	BLS/E/1x57-70W/QBX	5200	70.0	74	75.5	69	82	0.35	0.31 12	13248



# 2D Watt-Miser™ lamp

We all like to save where we can.

Cut your energy cost by up to 14% and protect the environment by switching to Watt-Miser™.

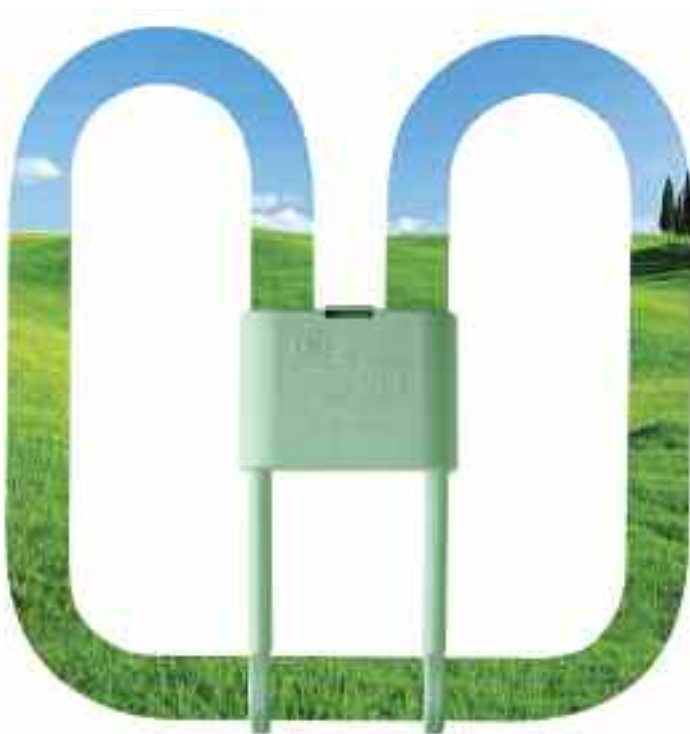

## 2D Watt-Miser™

### Energy Savers

- 15,000 hours, the longest life in the industry
- A Class energy rating
- Lumen/Watt: up to 90Lm/W
- 100% retrofit
- Environmentally friendly
- 28W energy saving is up to 14%, 38W energy saving up to 10%



# Compact fluorescent lamps

## Biax™ – Plug-In

### Biax™ 2D – 2 pin Internal Starter



Watts	Length mm	Cap	Product Description	CCT K	CRI Ra	Initial lumens	Rated Average Life Hours	Pack Qty	EE Class	Volts	I (A)	Product Code
16	138x142	GR8	F162D/827	2700	82	1050	15000	20	A	103	0.195	41744
			F162D/835	3500	82	1050	15000	20	A	103	0.195	41745
			F162D/860	6000	82	1050	15000	20	A	103	0.195	41749

### 2D Watt-Miser – 2 pin Internal Starter

28	204	GR8	F282DT5/827	2700	82	2250	15000	20	A	115	0.32	10546
----	-----	-----	-------------	------	----	------	-------	----	---	-----	------	-------

### 2D Watt-Miser™ – 4 pin External Starter Required



Rated power (W)	Actual power (W)	Length mm	Cap	Product Description	CCT K	CRI Ra	Initial lumens	Rated Average Life Hours	Pack Qty	EE Class	Volts	I (A)	Product Code
10	-	95	GR10	F10W/2D/827/4P	2700	82	650	8000	20	B	72	0.180	88105
10	-	95	GR10	F10W/2D/835/4P	3500	82	650	8000	20	B	72	0.180	88106
16	14	141	GR10q	F162D/827/4P	2700	82	1050	15000	20	A	103	0.195	41746
	24			F162D/835/4P	3500	82	1050	15000	20	A	103	0.195	41747
21	19	142	GR10q	F212D/827/4P	2700	82	1350	15000	20	A	102	0.26	41794
				F212D/835/4P	3500	82	1350	15000	20	A	102	0.26	41806
				F212D/860/4P	6000	82	1350	15000	20	A	102	0.26	41808
28	24	204	GR10q	F282DT5/827/4P	2700	82	1350	15000	20	A	115	0.32	10547
				F282DT5/835/4P	3500	82	2250	15000	20	A	115	0.32	10567
				F282DT5/840/4P	4000	82	2250	15000	20	A	115	0.32	10548
38	36	204	GR10q	F382DT5/827/4P	2700	82	3000	15000	20	A	117	0.41	10550
				F382DT5/835/4P	3500	82	3000	15000	20	A	117	0.41	10566
55*	-	206	GRY10q-3	F552D/827/A/4P	2700	82	3900	15000	20	A	78	0.7	37523
				F552D/835/A/4P	3500	82	3900	15000	20	A	78	0.7	37528

\* 55W Watt-Miser is expected to be introduced in Q2 2009

### Biax™ 2D™ – with Integral Control Gear Operates on 230/240 Volts



Watts	Length mm	Cap	Product Description	CCT K	CRI Ra	Initial lumens	Rated Average Life Hours	Pack Qty	EE Class	Tube Diameter mm	Width	Product Code
18	141	GRZ 10d	FLE18W2D/827/GR10	2700	82	1150	10000	10	A	T4-13	137	18122
			FLE18W2D/830/GR10	3000	82	1150	10000	10	A	T4-13	137	18121
			FLE18W2D/835/GR10	3500	82	1150	10000	10	A	T4-13	137	18123
			FLE18W2D/840/GR10	4000	82	1150	10000	10	A	T4-13	137	18120
30	206	GRZ 10t	FLE30W2D/827/GR10	2700	82	2050	10000	48	A	T6-18.5	202	92596
			FLE30W2D/835/GR10	3500	82	2050	10000	48	A	T6-18.5	202	92598

\* Under consideration with IEC



### Electronic Biax™ Extra Mini Hex T3 220-240V

Watts	Length mm	Cap	Product Description	CCT K	CRI Ra	Initial lumens	Rated Average Life Hours	Pack Qty	EE Class	Tube number	Diameter	Product Code
9	116	E14	TU FLE9TBX/XM/827 220-240V E14 BX 1/10	2700	82	480	15000	10	A	6	42	43342
9	115	E27	TU FLE9TBX/XM/827 220-240V E27 BX 1/10	2700	82	480	15000	10	A	6	42	43343
9	114	B22	TU FLE9TBX/XM/827 220-240V B22 BX 1/10	2700	82	480	15000	10	A	6	42	43344
9	116	E14	TU FLE9TBX/XM/840 220-240V E14 BX 1/10	4000	82	480	15000	10	A	6	42	43345
9	115	E27	TU FLE9TBX/XM/840 220-240V E27 BX 1/10	4000	82	480	15000	10	A	6	42	43346
9	114	B22	TU FLE9TBX/XM/840 220-240V B22 BX 1/10	4000	82	480	15000	10	A	6	42	43348
9	115	E27	TU FLE9TBX/XM/865 220-240V E27 BX 1/10	6500	82	480	15000	10	A	6	42	43350
11	116	E14	TU FLE11TBX/XM/827 220-240V E14 BX 1/10	2700	82	600	15000	10	A	6	42	43352
11	115	E27	TU FLE11TBX/XM/827 220-240V E27 BX 1/10	2700	82	600	15000	10	A	6	42	43353
11	114	B22	TU FLE11TBX/XM/827 220-240V B22 BX 1/10	2700	82	600	15000	10	A	6	42	43354
11	116	E14	TU FLE11TBX/XM/840 220-240V E14 BX 1/10	4000	82	600	15000	10	A	6	42	43355
11	115	E27	TU FLE11TBX/XM/840 220-240V E27 BX 1/10	4000	82	600	15000	10	A	6	42	43356
11	114	B22	TU FLE11TBX/XM/840 220-240V B22 BX 1/10	4000	82	600	15000	10	A	6	42	43358
11	116	E14	TU FLE11TBX/XM/865 220-240V E14 BX 1/10	6500	82	600	15000	10	A	6	42	43360
11	115	E27	TU FLE11TBX/XM/865 220-240V E27 BX 1/10	6500	82	600	15000	10	A	6	42	43361
15	128	E27	TU FLE15TBX/XM/827 220-240V E27 BX1/10	2700	82	900	15000	10	A	6	42	43364
15	127	B22	TU FLE15TBX/XM/827 220-240V B22 BX1/10	2700	82	900	15000	10	A	6	42	43365
15	128	E27	TU FLE15TBX/XM/840 220-240V E27 BX1/10	4000	82	900	15000	10	A	6	42	43366
15	127	B22	TU FLE15TBX/XM/840 220-240V B22 BX1/10	4000	82	900	15000	10	A	6	42	43367
20	143	E27	TU FLE20TBX/XM/827 220-240V E27 BX1/10	2700	82	1200	15000	10	A	6	42	43370
20	142	B22	TU FLE20TBX/XM/827 220-240V B22 BX1/10	2700	82	1200	15000	10	A	6	42	43371
20	143	E27	TU FLE20TBX/XM/840 220-240V E27 BX1/10	4000	82	1200	15000	10	A	6	42	43338
20	142	B22	TU FLE20TBX/XM/840 220-240V B22 BX1/10	4000	82	1200	15000	10	A	6	42	43339
20	143	E27	TU FLE20TBX/XM/865 220-240V E27 BX1/10	6500	82	1200	15000	10	A	6	42	43340
20	142	B22	TU FLE20TBX/XM/865 220-240V B22 BX1/10	6500	82	1200	15000	10	A	6	42	43341



### Electronic Biax™ Extra Mini Oct T3 220-240V

Watts	Length mm	Cap	Product Description	CCT K	CRI Ra	Initial lumens	Rated Average Life Hours	Pack Qty	EE Class	Tube number	Product Code
20	135	E27	FLE20QBXXM/827 E27 220-240V BX	2700	82	1200	15000	10	A	8	23017
20	135	E27	FLE20QBXXM/840 E27 220-240V BX	4000	82	1200	15000	10	A	8	23018
20	135	E27	FLE20QBXXM/865 E27 220-240V BX	6500	82	1200	15000	10	A	8	23022
20	134	B22	FLE20QBXXM/827 B22 220-240V BX	2700	82	1200	15000	10	A	8	23033
23	149	E27	FLE23QBXXM/827 E27 220-240V BX	2700	82	1500	15000	10	A	8	23106
23	149	E27	FLE23QBXXM/840 E27 220-240V BX	4000	82	1500	15000	10	A	8	23107
23	149	E27	FLE23QBXXM/865 E27 220-240V BX	6500	82	1500	15000	10	A	8	23110



### Electronic Eco T3 220-240V

Watts	Length mm	Cap	Product Description	CCT K	CRI Ra	Lumen	Rated avg life	Pack Qty	EE Class	Tube number	Diameter	Product Code
9	115	E27	FLE9TBX/T3/827/E27 220-240V 1/8T 10Y	2700	82	405	10000	10	A	6	46	88695
9	114	B22	FLE9TBX/T3/827/B22 220-240V 1/8T 10Y	2700	82	405	10000	10	A	6	46	88696
9	113	E14	FLE9TBX/T3/827/E14 220-240V 1/8T 10Y	2700	82	405	10000	10	A	6	46	88697
9	115	E27	FLE9TBX/T3/840/E27 220-240V BX1/10 10Y	4000	82	405	10000	10	A	6	46	88698
9	114	B22	FLE9TBX/T3/840/B22 220-240V BX1/10 10Y	4000	82	405	10000	10	A	6	46	88699
9	113	E14	FLE9TBX/T3/840/E14 220-240V BX1/10 10Y	4000	82	405	10000	10	A	6	46	88700
9	115	E27	FLE9TBX/T3/865/E27 220-240V BX1/10 10Y	6500	82	405	10000	10	A	6	46	88701
9	114	B22	FLE9TBX/T3/865/B22 220-240V BX1/10 10Y	6500	82	405	10000	10	A	6	46	88702
9	113	E14	FLE9TBX/T3/865/E14 220-240V BX1/10 10Y	6500	82	405	10000	10	A	6	46	88703
11	113	E27	FLE11TBX/T3/827/E27 220-240V 1/8T 10Y	2700	82	640	10000	10	A	6	46	72689
11	123	B22	FLE11TBX/T3/827/B22 220-240V 1/8T 10Y	2700	82	640	10000	10	A	6	46	72690
11	126	E14	FLE11TBX/T3/827/E14 220-240V BX1/10 10Y	2700	82	640	10000	10	A	6	46	88706
11	126	E14	FLE11TBX/T3/840/E14 220-240V BX1/10 10Y	4000	82	580	10000	10	A	6	46	88709
11	126	E14	FLE11TBX/T3/865/E14 220-240V BX1/10 10Y	6500	82	580	10000	10	A	6	46	88712
15	123	E27	FLE15TBX/T3/827/E27 220-240V 1/8T 10Y	2700	82	872	10000	10	A	6	52	72688
15	125	B22	FLE15TBX/T3/827/B22 220-240V 1/8T 10Y	2700	82	872	10000	10	A	6	52	88713
15	137	E27	FLE15TBX/T3/840/E27 220-240V BX1/10 10Y	4000	82	872	10000	10	A	6	52	88714
15	147	B22	FLE15TBX/T3/840/B22 220-240V BX1/10 10Y	4000	82	872	10000	10	A	6	52	88715
15	137	E27	FLE15TBX/T3/865/E27 220-240V BX1/10 10Y	6500	82	872	10000	10	A	6	52	88716
15	136	B22	FLE15TBX/T3/865/B22 220-240V BX1/10 10Y	6500	82	872	10000	10	A	6	52	88717
20	155	E27	FLE20TBX/T3/827/E27 220-240V 1/8T 10Y	2700	82	1152	10000	10	A	6	52	88718
20	154	B22	FLE20TBX/T3/827/B22 220-240V 1/8T 10Y	2700	82	1152	10000	10	A	6	52	88719
20	154	E27	FLE20TBX/T3/840/E27 220-240V BX1/10 10Y	4000	82	1152	10000	10	A	6	52	88720
20	155	B22	FLE20TBX/T3/840/B22 220-240V BX1/10 10Y	4000	82	1152	10000	10	A	6	52	88721
20	154	E27	FLE20TBX/T3/865/E27 220-240V BX1/10 10Y	6500	82	1152	10000	10	A	6	52	88722
20	155	B22	FLE20TBX/T3/865/B22 220-240V BX1/10 10Y	6500	82	1152	10000	10	A	6	52	88723
23	145	E27	FLE23QBXX/T3/827/E27 220-240V BX1/10 10Y	2700	82	1380	10000	10	A	8	48	TBD
23	144	B22	FLE23QBXX/T3/827/B22 220-240V BX1/10 10Y	2700	82	1380	10000	10	A	8	48	TBD
23	145	E27	FLE23QBXX/T3/840/E27 220-240V BX1/10 10Y	4000	82	1380	10000	10	A	8	48	TBD
23	144	B22	FLE23QBXX/T3/840/B22 220-240V BX1/10 10Y	4000	82	1380	10000	10	A	8	48	TBD
23	145	E27	FLE23QBXX/T3/865/E27 220-240V BX1/10 10Y	6500	82	1380	10000	10	A	8	48	TBD
23	144	B22	FLE23QBXX/T3/865/B22 220-240V BX1/10 10Y	6500	82	1380	10000	10	A	8	48	TBD



# Compact fluorescent lamps Stick range

## Electronic Biax™ Mini Eco T3 220-240V

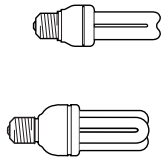

Watts	Length mm	Cap	Product Description	CCT K	CRI Ra	Initial lumens	Rated Average Life Hours	Pack Qty	EE Class	Tube number	Diameter	Product Code
9	115	E14	FLE9TBT3/827/E14 220-240V BX1/10 6Y	2700	82	405	6000	10	A	6	46	89016 / 40828
9	115	E27	FLE9TBT3/827/E27 BX 1/10 GE 6Y	2700	82	405	6000	10	A	6	46	70939 / 82896
9	114	B22	FLE9TBT3/827/B22 BX 1/10 GE 6Y	2700	82	405	6000	10	A	6	46	40517 / 70634
9	115	E14	FLE9TBT3/840/E14 220-240V BX1/10 6Y	4000	82	405	6000	10	A	6	46	72726 / 40830
9	115	E27	FLE9TBT3/840/E27 220-240V BX GE 6Y	4000	82	405	6000	10	A	6	46	40620 / 40833
9	115	E14	FLE9TBT3/865/E14 220-240V BX1/10 6Y	6500	82	405	6000	10	A	6	46	40638 / 40835
9	115	E27	FLE9TBT3/865/E27 220-240V BX1/10 6Y	6500	82	405	6000	10	A	6	46	40836
11	124	E14	FLE11TBT3/827/E14 220-240V BX GE 6Y	2700	82	580	6000	10	A	6	46	70941 / 40831
11	124	E27	FLE11TBT3/827/E27 BX 1/10 GE 6Y	2700	82	580	6000	10	A	6	46	40559 / 40837
11	123	B22	FLE11TBT3/827/B22 BX 1/10 GE 6Y	2700	82	580	6000	10	A	6	46	40573 / 70631
11	124	E14	FLE11TBT3/840/E14 220-240V BX GE 6Y	4000	82	580	6000	10	A	6	46	72722 / 40838
11	124	E27	FLE11TBT3/840/E27 220-240V BX GE 6Y	4000	82	580	6000	10	A	6	46	40644 / 40839
11	123	B22	FLE11TBT3/840/B22 220-240V BX GE 6Y	4000	82	580	6000	10	A	6	46	72724 / 41303
11	124	E14	FLE11TBT3/865/E14 220-240V BX GE 6Y	6500	82	580	6000	10	A	6	46	40646 / 40842
11	124	E27	FLE11TBT3/865/E27 220-240V BX GE 6Y	6500	82	580	6000	10	A	6	46	40844
15	145/137	E27	FLE15TBT3/827/E27 BX 1/10 GE 6Y	2700	82	799	6000	10	A	6	46	26447
15	145/137	B22	FLE15TBT3/827/B22 BX 1/10 GE 6Y	2700	82	799	6000	10	A	6	46	72720 / 26455
15	145/137	E27	FLE15TBT3/840/E27 BX 1/10 GE 6Y	4000	82	799	6000	10	A	6	46	88271 / 26467
15	145/137	E27	FLE15TBT3/865/E27 BX 1/10 GE 6Y	6500	82	799	6000	10	A	6	46	88270 / 42748
20	154	E27	FLE20TBT3/827/E27 BX 1/10 GE 6Y	2700	82	1152	6000	10	A	6	46	88267 / 82911
20	154	B22	FLE20TBT3/827/B22 BX 1/10 GE 6Y	2700	82	1152	6000	10	A	6	46	70624
20	154	E27	FLE20TBT3/840/E27 BX 1/10 GE 6Y	4000	82	1152	6000	10	A	6	46	88264
20	154	E27	FLE20TBT3/865/E27 BX 1/10 GE 6Y	6500	82	1152	6000	10	A	6	46	88263
23	158	E27	FLE23QBT3/827/E27 BX 1/10 GE 6Y	2700	82	1400	6000	10	A	8	54	73210
23	158	B22	FLE23QBT3/865/E27 BX 1/10 GE 6Y	6500	82	1371	6000	10	A	8	54	73208
23	158	E27	FLE23QBT3/865/B22 BX 1/10 GE 6Y	6500	82	1371	6000	10	A	8	54	73211

## Electronic Biax™ Eco T4 220-240V

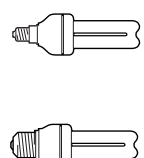

Watts	Length mm	Cap	Product Description	CCT K	CRI Ra	Initial lumens	Rated Average Life Hours	Pack Qty	EE Class	Tube number	Diameter	Product Code
9	138	E14	FLE9DBX/827/E14 220-240V BX 1/10 6Y	2700	82	490	6000	10	A	4	46	27934
9	138	E14	FLE9DBX/865/E14 220-240V BX 1/10 6Y	6500	82	450	6000	10	A	4	46	27517
9	138	E27	FLE9DBX/827/E27 220-240V BX 1/10 6Y	2700	82	490	6000	10	A	4	46	27940
9	138	E27	FLE9DBX/840/E27 220-240V BX 1/10 6Y	4000	82	480	6000	10	A	4	46	27512
9	138	E27	FLE9DBX/865/E27 220-240V BX 1/10 6Y	6500	82	450	6000	10	A	4	46	27514
9	137	B22	FLE9DBX/827/B22 220-240V BX 1/10 6Y	2700	82	490	6000	10	A	4	46	27941
11	149	E14	FLE11DBX/827/E14 220-240V BX 1/10 6Y	2700	82	610	6000	10	A		46	27946
11	149	E14	FLE11DBX/865/E14 220-240V BX 1/10 6Y	6500	82	580	6000	10	A	4	46	27531
11	149	E27	FLE11DBX/827/E27 220-240V BX 1/10 6Y	2700	82	610	6000	10	A	4	46	27947
11	149	E27	FLE11DBX/840/E27 220-240V BX 1/10 6Y	4000	82	600	6000	10	A	4	46	27527
11	149	E27	FLE11DBX/865/E27 220-240V BX 1/10 6Y	6500	82	580	6000	10	A	4	46	27528
11	148	B22	FLE11DBX/827/B22 220-240V BX 1/10 6Y	2700	82	610	6000	10	A	4	46	27949
11	148	B22	FLE11DBX/865/B22 220-240V BX 1/10 6Y	6500	82	580	6000	10	A	4	46	27534
15	140.5	E27	FLE15TBT3/827/E27 220-240V BX1/10 6Y	2700	82	900	6000	10	A	6	52/49	13328/70857
15	140.5	E27	FLE15TBT3/840/E27 220-240V BX1/10 6Y	4000	82	900	6000	10	A	6	52/49	13329/70855
15	140.5	E27	FLE15TBT3/865/E27 220-240V BX1/10 6Y	6500	82	900	6000	10	A	6	52/49	13330/70854
15	139.5	B22	FLE15TBT3/827/B22 220-240V BX1/10 6Y	2700	82	900	6000	10	A	6	52/49	13332/70856
15	139.5	B22	FLE15TBT3/865/B22 220-240V BX1/10 6Y	6500	82	900	6000	10	A	6	52/49	13334/70853
20	155	E27	FLE20TBT3/827/E27 220-240V BX1/10 6Y	2700	82	1200	6000	10	A	6	52/49	13336/70852
20	155	E27	FLE20TBT3/840/E27 220-240V BX1/10 6Y	4000	82	1200	6000	10	A	6	52/49	13337/70849
20	155	E27	FLE20TBT3/865/E27 220-240V BX1/10 6Y	6500	82	1200	6000	10	A	6	52/49	13342/70829
20	154	B22	FLE20TBT3/827/B22 220-240V BX1/10 6Y	2700	82	1200	6000	10	A	6	52/49	13344/70850
20	154	B22	FLE20TBT3/865/B22 220-240V BX1/10 6Y	6500	82	1200	6000	10	A	6	52/49	13350/70827
23	165	E27	FLE23TBT3/827/E27 220-240V BX1/10 6Y	2700	82	1500	6000	10	A	6	52	13354
23	165	E27	FLE23TBT3/840/E27 220-240V BX1/10 6Y	4000	82	1500	6000	10	A	6	52	13355
23	165	E27	FLE23TBT3/865/E27 220-240V BX1/10 6Y	6500	82	1500	6000	10	A	6	52	13356
23	164	B22	FLE23TBT3/827/B22 220-240V BX1/10 6Y	2700	82	1500	6000	10	A	6	52	13358
23	164	B22	FLE23TBT3/865/B22 220-240V BX1/10 6Y	6500	82	1500	6000	10	A	6	52	13361



### Electronic Spiral T2 220-240V

Watts	Length mm	Diameter	Cap	Product Description	CCT K	CRI Ra	Initial lumens	Rated Average Life Hours	Pack Qty	EE Class	Product Code
8	86.5	46	E14	FLE8HLX/T2/827/E14 BX 1/10 GE 8Y	2700	82	460	8000	10	A	45254
8	86.5	46	E14	FLE8HLX/T2/865/E14 BX 1/10 GE 8Y	6500	82	460	8000	10	A	71002
8	86.5	46	E27	FLE8HLX/T2/827/E27 BX 1/10 GE 8Y	2700	82	460	8000	10	A	45251
8	86.5	46	E27	FLE8HLX/T2/865/E27 BX 1/10 GE 8Y	6500	82	460	8000	10	A	71003
8	86.5	46	B22	FLE8HLX/T2/827/B22 BX 1/10 GE 8Y	2700	82	460	8000	10	A	45253
12	100	53	E14	FLE12HLX/T2/827/E14 BX 1/10 GE 8Y	2700	82	700	8000	10	A	45267
12	100	53	E14	FLE12HLX/T2/865/E14 BX 1/10 GE 8Y	6500	82	700	8000	10	A	71004
12	100	53	E27	FLE12HLX/T2/827/E27 BX 1/10 GE 8Y	2700	82	700	8000	10	A	45260
12	100	53	E27	FLE12HLX/T2/865/E27 BX 1/10 GE 8Y	6500	82	700	8000	10	A	71005
12	100	53	B22	FLE12HLX/T2/827/B22 BX 1/10 GE 8Y	2700	82	700	8000	10	A	45269
15	100	53	E27	FLE15HLX/T2/827/E27 BX 1/10 GE 8Y	2700	82	950	8000	10	A	45271
15	100	53	E27	FLE15HLX/T2/865/E27 BX 1/10 GE 8Y	6500	82	950	8000	10	A	71006
15	100	53	B22	FLE15HLX/T2/827/B22 BX 1/10 GE 8Y	2700	82	950	8000	10	A	45272
20	108	57	E27	FLE20HLX/T2/827/E27 1/6T GE 8Y	2700	82	1200	8000	10	A	88680
20	108	57	B22	FLE20HLX/T2/827/B22 1/6T GE 8Y	2700	82	1200	8000	10	A	88681
20	108	57	E27	FLE20HLX/T2/840/E27 BX 1/10 GE 8Y	4000	82	1200	8000	10	A	88684
20	108	57	E27	FLE20HLX/T2/865/E27 BX 1/10 GE 8Y	6500	82	1200	8000	10	A	88685
20	108	57	E27	FLE20HLX/T2/865/E27 BX 1/10 GE 8Y	6500	82	1200	8000	10	A	88685
23	125	57	E27	FLE23HLX/T2/827/E27 1/6T GE 8Y	2700	82	1380	8000	10	A	88686
23	125	57	B22	FLE23HLX/T2/827/B22 1/6T GE 8Y	2700	82	1380	8000	10	A	88687
23	125	57	E27	FLE23HLX/T2/840/E27 BX 1/10 GE 8Y	4000	82	1380	8000	10	A	88690
23	125	57	E27	FLE23HLX/T2/865/E27 BX 1/10 GE 8Y	6500	82	1380	8000	10	A	88691

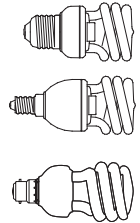

### Electronic Spiral T3 220-240V

11	120	46	E27	FLE11HLX/T3/827/E27 BX 1/10 GE 6Y TS	2700	82	580	6000	10	A	40438/82926
11	119	46	B22	FLE11HLX/T3/827/B22 BX 1/10 GE 6Y TS	2700	82	580	6000	10	A	46621/70620
11	120	46	E27	FLE11HLX/T3/865/E27 BX 1/10 GE 6Y	6500	82	580	6000	10	A	43271
20	128	59	E27	FLE20HLX/T3/827/E27 BX 1/10 GE 6Y TS	2700	82	1152	6000	10	A	40443/82941
20	127	59	B22	FLE20HLX/T3/827/B22 BX 1/10 GE 6Y TS	2700	82	1152	6000	10	A	88123
20	128	59	E27	FLE20HLX/T3/865/E27 BX 1/10 GE 6Y	6500	82	1152	6000	10	A	43270



### Electronic Decor T2 range 220-240V

GLS types

8	102	53.5	E14	FLE8GLS/T2/827/E14 BX 1/10 GE 6Y	2700	82	360	6000	10	A	45848
8	102	53.5	E27	FLE8GLS/T2/827/E27 BX 1/10 GE 6Y	2700	82	360	6000	10	A	45850
8	102	53.5	B22	FLE8GLS/T2/827/B22 BX 1/10 GE 6Y	2700	82	360	6000	10	A	45849
8	102	53.5	E14	FLE8GLS/T2/840/E14 BX 1/10 GE 6Y	4000	82	360	6000	10	A	88151
8	102	53.5	E27	FLE8GLS/T2/840/E27 BX 1/10 GE 6Y	4000	82	360	6000	10	A	88152
8	102	53.5	B22	FLE8GLS/T2/827/B22 BX 1/10 GE 6Y	2700	82	360	6000	10	A	45849
12	112	57	E14	FLE12GLS/T2/827/E14 BX 1/10 GE 6Y	2700	82	600	6000	10	A	45835
12	112	57	E27	FLE12GLS/T2/827/E27 BX 1/10 GE 6Y	2700	82	600	6000	10	A	45837
12	112	57	E27	FLE12GLS/T2/840/E27 BX 1/10 GE 6Y	4000	82	600	6000	10	A	88150
12	112	57	B22	FLE12GLS/T2/827/B22 BX 1/10 GE 6Y	2700	82	600	6000	10	A	45836
15	123	62	E27	FLE15GLS/T2/827/E27 BX 1/10 GE 6Y	2700	82	825	6000	10	A	45831
15	123	62	E27	FLE15GLS/T2/840/E27 BX 1/10 GE 6Y	4000	82	825	6000	10	A	88148

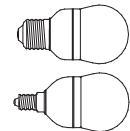

# Compact fluorescent lamps

## Decorative range

### Electronic GLS T3 220-240V

Watts	Length mm	Diameter	Cap	Product Description	CCT K	CRI Ra	Initial lumens	Rated Average Life Hours	Pack Qty	EE Class	Product Code
7	110	60	E14	FLE7GLS/827 E14 220/240V BX GE 6Y	2700	82	286	6000	10	A	40121
7	110	60	E27	FLE7GLS/827 E27 220/240V BX GE 6Y	2700	82	286	6000	10	A	40130
7	109	60	B22	FLE7GLS/827 B22 220/240V BX GE 6Y	2700	82	286	6000	10	A	40133
9	116	60	E14	FLE9GLS/827 E14 220/240V BX GE 6Y	2700	82	405	6000	10	A	40147
9	116	60	E27	FLE9GLS/827 E27 220/240V BX GE 6Y	2700	82	405	6000	10	A	40148
9	115	60	B22	FLE9GLS/827 B22 220/240V BX GE 6Y	2700	82	405	6000	10	A	40152
11	124	60	E14	FLE11GLS/827 E14 220/240V BXGE 6Y	2700	82	580	6000	10	A	70899
11	124	60	E27	FLE11GLS/827 E27 220/240V BXGE 6Y	2700	82	580	6000	10	A	40154
11	123	60	B22	FLE11GLS/827 B22 220-240V BXGE 6Y	2700	82	580	6000	10	A	40155
15	135	65	E27	FLE15GLS/827 E27 220-240V BX GE 6Y	2700	82	799	6000	10	A	40156
15	134	65	B22	FLE15GLS/827 B22 220-240V BX GE 6Y	2700	82	799	6000	10	A	40157
20	152	75	E27	FLE20GLS/827 E27 220-240V BX GE 6Y	2700	82	1152	6000	10	A	40158
20	151	75	B22	FLE20GLS/827 B22 220-240V BX GE 6Y	2700	82	1152	6000	10	A	40159

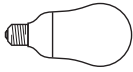

### Electronic Candle T2 220-240V

5	106	38	E14	FLE5CDL/T2/827/E14 BX 1/10 GE 6Y	2700	82	180	6000	10	A	73406
5	106	38	E14	FLE5CDL/T2/840/E14 BX 1/10 GE 6Y	4000	82	180	6000	10	A	73408
5	106	38	E27	FLE5CDL/T2/827/E27 BX 1/10 GE 6Y	2700	82	180	6000	10	A	88852
5	106	38	E27	FLE5CDL/T2/840/E27 BX 1/10 GE 6Y	4000	82	180	6000	10	A	73410
5	106	38	B22	FLE5CDL/T2/827/B22 BX 1/10 GE 6Y	2700	82	180	6000	10	A	88853
7	106	38	E14	FLE7CDL/T2/827/E14 BX 1/10 GE 6Y	2700	82	286	6000	10	A	73411
7	106	38	E14	FLE7CDL/T2/840/E14 BX 1/10 GE 6Y	4000	82	286	6000	10	A	73451
7	106	38	E27	FLE7CDL/T2/827/E27 BX 1/10 GE 6Y	2700	82	286	6000	10	A	88855
7	106	38	E27	FLE7CDL/T2/840/E27 BX 1/10 GE 6Y	4000	82	286	6000	10	A	73453
7	106	38	B22	FLE7CDL/T2/827/B22 BX 1/10 GE 6Y	2700	82	286	6000	10	A	88856

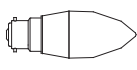
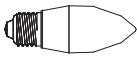
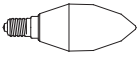

### Electronic Candle T3 220-240V

5	114	40	E14	FLE5CDL/827 E14 220-240V BX GE 6Y	2700	48	177	6000	10	A	40160
7	130	40	E14	FLE7CDL/827 E14 220-240V BX GE 6Y	2700	67	286	6000	10	A	40162
9	140	50	E14	FLE9CDL/827 E14 220-240V BX GE 6Y	2700	82	405	6000	10	A	40163
9	140	50	E27	FLE9CDL/827 E27 220-240V BX GE 6Y	2700	82	405	6000	10	A	70893
9	139	50	B22	FLE9CDL/827 B22 220-240V BX GE 6Y	2700	82	405	6000	10	A	40171

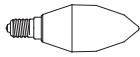

### Electronic Twisted Candle T3 220-240V

5	114	40	E14	FLE5TWSTCDL/OP/827 E14 BX1/10 GE 6Y	2700	82	177	6000	10	A	72704
5	114	40	E14	FLE5TWSTCDL/AMBER E14 BX1/10 GE 6Y	Amber	82	177	6000	10	A	72706
7	130	40	E14	FLE7TWSTCDL/OP/827 E14 BX1/10 GE 6Y	2700	82	286	6000	10	A	72705
7	130	40	E14	FLE7TWSTCDL/AMBER E14 BX1/10 GE 6Y	Amber	82	286	6000	10	A	72707



### Electronic Bent-Tip Candle T3 220-240V

7	156	40	E14	FLE7BTCDL/OP/827 E14 BL1/10 GE6Y	2700	82	286	6000	blister	A	88162
---	-----	----	-----	----------------------------------	------	----	-----	------	---------	---	-------



### Electronic Reflector T2 220-240V

7	92	R50	E14	FLE7R50/T2/827/E14 BX 1/10 GE 6Y	2700	82		6000	10	N/A*	88845
7	92	R50	E14	FLE7R50/T2/840/E14 BX 1/10 GE 6Y	4000	82		6000	10	N/A*	73403
7	92	R50	E27	FLE7R50/T2/827/E27 BX 1/10 GE 6Y	2700	82		6000	10	N/A*	88846
7	92	R50	B22	FLE7R50/T2/827/B22 BX 1/10 GE 6Y	2700	82		6000	10	N/A*	88847
11	105	R63	E14	FLE11R63/T2/827/E14 BX1/10 GE 6Y	2700	82		6000	10	N/A*	88848
11	105	R63	E14	FLE11R63/T2/840/E14 BX 1/10 GE 6Y	4000	82		6000	10	N/A*	73405
11	105	R63	E27	FLE11R63/T2/827/E27 BX1/10 GE 6Y	2700	82		6000	10	N/A*	88849
11	105	R63	B22	FLE11R63/T2/827/B22 BX1/10 GE 6Y	2700	82		6000	10	N/A*	88850

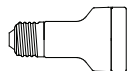

### Electronic Reflector T3 220-240V

7	112	50	E14	FLE7R50/827 E14 220-240V BX GE 6Y	2700	82	79	6,000	10	N/A*	40206
9	114	63	E14	FLE9R63/827 E14 220-240V BX GE 6Y	2700	82	115	6,000	10	N/A*	70933
9	114	63	E27	FLE9R63/827 E27 220-240V BX GE 6Y	2700	82	115	6,000	10	N/A*	70935
11	123	63	E27	FLE11XM/R63/827 E27 220-240V BX GE	2700	82	280	8,000	6	N/A*	82158

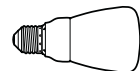

# Compact fluorescent lamps

## Decorative range

### Electronic GU10 - T2 220-240V

Watts	Length mm	Diameter	Cap	Product Description	CCT K	CRI Ra	Initial lumens	Rated Average Life Hours	Pack Qty	EE Class	Product Code
7	87	50	GU10	FLE7GU10/T2/827 BX 1/10 GE 6Y	2700	82	6000	10	N/A*	73454	
7				FLE7GU10/T2/840 BX 1/10 GE 6Y	4000	82	6000	10	N/A*	73380	
9	87	50	GU10	FLE9GU10/T2/827 BX 1/10 GE 6Y	2700	82	6000	10	N/A*	88858	
9				FLE9GU10/T2/840 BX 1/10 GE 6Y	4000	82	6000	10	N/A*	73379	

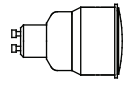

### Electronic Reflector PAR38 - 220-240V

23	120		E27	FLE23PAR38/827/E27	2700	82	8000	10	N/A*	88692
23	120		E27	FLE23PAR38/840/E27	4000	82	8000	10	N/A*	88693
23	120		E27	FLE23PAR38/865/E27	6500	82	8000	10	N/A*	88694
23	120		B22	FLE23PAR38/827/B22	2700	82	8000	10	N/A*	73384

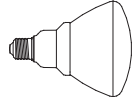

### Electronic Spherical T2 220-240V

5	92	45	E14	FLE5SPH/T2/827/E14 BX 1/10 GE 8Y /05	2700	82	180	6000	10	A	88839
5	92	45	E14	FLE5SPH/T2/840/E14 BX 1/10 GE 8Y /05	4000	82	180	6000	10	A	73387
5	92	45	E27	FLE5SPH/T2/827/E27 BX 1/10 GE 8Y /05	2700	82	180	6000	10	A	73386
5	92	45	E27	FLE5SPH/T2/840/E27 BX 1/10 GE 8Y /05	4000	82	180	6000	10	A	73389
5	92	45	E27	FLE5SPH/T2/865/E27 BX 1/10 GE 8Y /05	6500	82	180	6000	10	A	73395
5	92	45	B22	FLE5SPH/T2/827/B22 BX 1/10 GE 8Y /05	2700	82	180	6000	10	A	88841
7	92	45	E14	FLE7SPH/T2/827/E14 BX 1/10 GE 8Y /05	2700	82	286	6000	10	A	88842
7	92	45	E14	FLE7SPH/T2/840/E14 BX 1/10 GE 8Y /05	4000	82	286	6000	10	A	73402
7	92	45	E27	FLE7SPH/T2/827/E27 BX 1/10 GE 8Y /05	2700	82	286	6000	10	A	73396
7	92	45	E27	FLE7SPH/T2/840/E27 BX 1/10 GE 8Y /05	4000	82	286	6000	10	A	73398
7	92	45	B22	FLE7SPH/T2/827/B22 BX 1/10 GE 8Y /05	2700	82	286	6000	10	A	88844

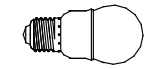
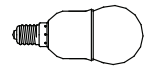

### Electronic Globe 220-240V

11	125	75	E27	FLE11TBX/XM/GG/827/E27 220-240V LBX1/6	2700	82	550	8000	6	A	92221
11	124	75	B22	FLE11TBX/XM/GG/827/B22 220-240V LBX1/6	2700	82	550	8000	6	A	93019
15	152	92	E27	FLE15TBX/L/GG/827 220-240V E27 LBX1/6	2700	82	750	10000	6	A	92216
15	152	92	E27	FLE15TBX/L/GG/840 220-240V E27 LBX1/6	4000	82	750	10000	6	A	12172
15	151	92	B22	FLE15TBX/L/GG/827 220-240V B22 LBX1/6	2700	82	750	10000	6	A	92213
20	180	118	E27	FLE20TBX/L/GG/827 220-240V E27 LBX1/6	2700	82	1050	10000	6	A	92220
20	180	118	E27	FLE20TBX/L/GG/840 220-240V E27 LBX1/6	4000	82	1050	10000	6	A	12173
20	179	118	B22	FLE20TBX/L/GG/827 220-240V B22 LBX1/6	2700	82	1050	10000	6	A	92217
23	180	120	E27	FLE23QBX/A/GG/827/E27 220-240V LBX1/6	2700	82	1250	12000	6	A	92190
23	180	120	E27	FLE23QBX/A/GG/840 E27 220-240 LBX1/6	4000	82	1250	12000	6	A	12174
23	179	120	B22	FLE23QBX/A/GG/827/B22 230-240V LBX1/6	2700	82	1250	12000	6	A	92189

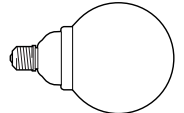
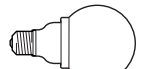

### Electronic Sensor 220-240V

With photo sensor - lights up at dusk, turns off at dawn

15	148	55	E27	FLE15TBX/827/E27 SENZ220-240V BX1/10	2700	82	800	6000	10	A	45299
	148	55	B22	FLE15TBX/827/B22 SENZ220-240V BX1/10	2700	82	800	6000	10	A	45301

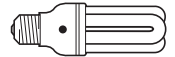

### Genura™ R80 220-240V

23	132		E27	EFL23W/827 R80 220-240V E27 LBX 1/6	2700	82	1100	15000	6	A	92244
23	132		E27	EFL23W/830 R80 220-240V E27 LBX 1/6	3000	82	1100	15000	6	A	92246

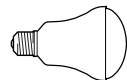

### Electronic Circlite T5 220-240V

22	73	230	E27	FLE22/CLITE/T5/827/E27 BX1/6 6Y	2700	82	1800	6000	10	A	73767
22	73	230	E27	FLE22/CLITE/T5/865/E27 BX1/6 6Y	6500	82	1600	6000	10	A	73768

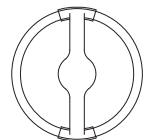

\*EU Commission Directive 98/11/EC does not apply energy category for reflector lamps.

# Compact fluorescent lamps

GE Biax™ compact fluorescents come in two lamp types – plug-in and electronic. While a majority of the features described here apply to both lamp types, plug-in lamps require separate running gear and that can effect the lamps' performance characteristics.

### Amalgam technology

GE amalgam dosing technology provides a more consistent light output, not only through lamp life, but also in varying ambient temperatures and lamp orientations.

### Using outside

When Biax™ lamps are employed outdoors, they must be used in enclosed fittings. The lamps will reach full brightness when the ambient temperature around the lamp reaches approximately 25°C. The effects of different ambient temperatures on light output for typical lamps is shown in the chart Fig 1. With amalgam products, 90% of light output is achieved between the temperatures of -10°C and +65°C.

### Enhancing colour quality

While the colour temperature of Biax™ is similar to an equivalent incandescent lamp (it produces the same 'whiteness' of light), the colour rendering performance (its ability to accurately reproduce colours) is slightly lower. It is this difference that may lead some users to feel that the light appears dull. However, Biax™ lamps, which use Polylux triphosphors, are far better at rendering colours than most commonly available fluorescent tubes.

### Characteristics of electronic lamps

As the electronic gear in the base of these lamps needs a full and constant current, they cannot be dimmed or used with other electronic switching devices.

### Eliminating flicker

Biax™ lamps operate at very high frequencies thus avoiding the annoying flicker typical of some fluorescent installations operating with conventional control gear.

### Using existing fittings

Biax™ lamps are much lighter than many conventional retrofit compact fluorescent lamps and therefore do not impose exceptional loads on light fittings.

### Warm-up times

GE Biax™ lamps offer an almost instant start, but require a few minutes to reach full brightness, particularly in colder temperatures. This slight time lag may initially make the lamp appear dull.

Fig 1 Light output relative to ambient temperature

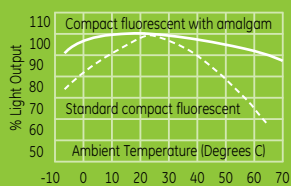

Biax™ maintains an acceptable level of light output within a normal range of temperatures.

Lumen maintenance characteristics of Biax™ and Electronic Biax™ lamps



One of the characteristics of Biax™ is a very low fall off in light output over the life of the lamp.



# Radial luminous intensity distribution (burning position: cap up)

Biax™ S • Biax™ S/E • Biax™ L

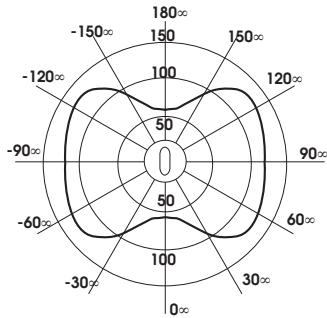

Biax™ D • Biax™ D/E

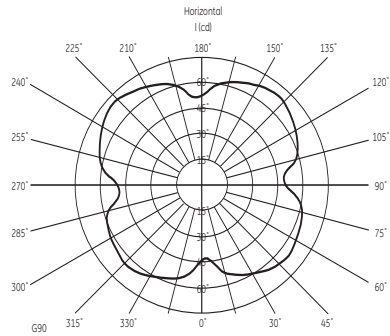

Biax™ T • Biax™ T/E

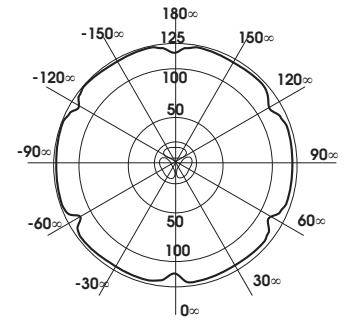

Biax™ Q/E

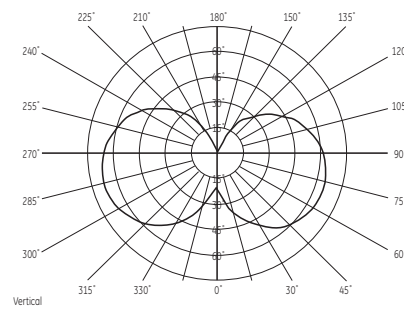
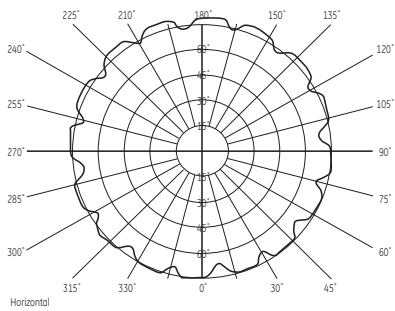

# Spectral distribution diagrams

2700 K

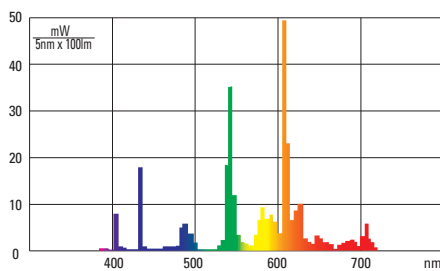

3000 K

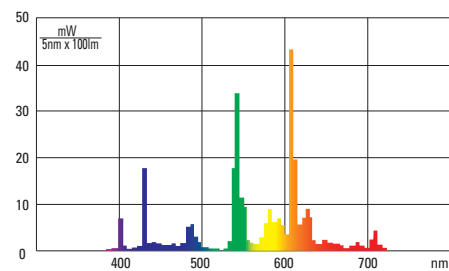

3500 K

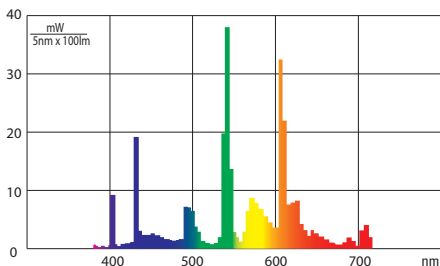

4000 K

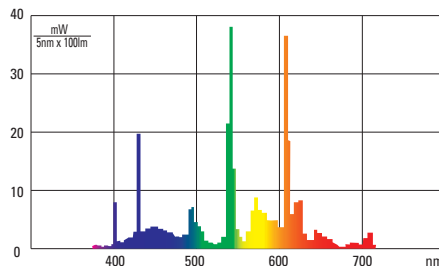

6500 K

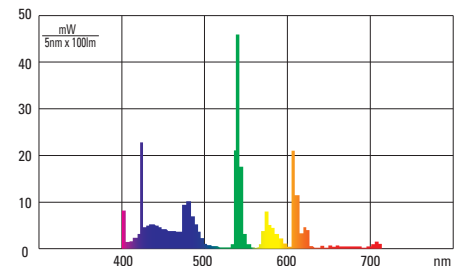

## High intensity discharge lamps

GE invented mercury lamps in 1931, high pressure sodium lamps in 1962 and metal halide in 1964.

High Intensity Discharge (HID) lamps are generally the most efficient light sources. Better energy efficiency helps to drive lower operating costs. Recent HID range falls into three main categories: metal halide, high pressure sodium and mercury vapour lamps.

High intensity discharge lamps are characterised by high reliability, low operating costs, and long life with various application possibilities from street to retail lighting. It offers a highly controllable point source of light and colour stability through life. Furthermore miniature Ceramic Metal Halide (CMH) lamps have opened new possibilities for lighting design with the introduction of 20W and 35W MR16 and SuperMini types especially for the retail sector.

High Pressure Sodium (HPS) lamps offer a great solution for street lighting application where energy efficiency, lumen output or lifetime are key. GE's HPS premium range : Lucalox XO with its robust design and its lifetime up to 32,000 hours and its efficacy level up to 150lm/w is currently the most efficient lamp type in the HID range. In terms of lifetime, HPS Standby -Superlife lamps can provide light up to 55,000 hours due to double arc tube applied.



## Content

Metal Halide selection guide	102
ConstantColor™ CMH	110
Arcstream™	111
Kolorarc™	112
Multi-Vapor™	112
Multi-Vapor™ High Output	112
Sportlight™	113
Lucalox™ T	117
Lucalox™ E	117
Lucalox™ XO	117
Lucalox™ PSL	117
Lucalox™ TD	118
Lucalox™ RFL	118
Lucalox™ E-Z	118
Lucalox™ I Elliptical Clear & Diffuse	118
Lucalox™ Superlife/Standby	118
Kolorlux Standard (MBF)	119
Blended Light	119
General information	120



# High intensity discharge lamps

## Selecting the right product

While all HID lamps offer outstanding efficiency and long life, there are distinct differences in performance among the three basic types of HID lamps. The following two charts should help you to understand these differences so that you can select the right lamp for your application.

### Key performance criteria

	Colour Temperature Options (K)	Colour Rendering (Ra)	Life (Hours)	Efficiency (LPW)
Metal Halide	3000 (WDL) 3500 (BDL) 4000 (NDL) 6000 (DL)	65-93	3,500-20,000	68-105
High Pressure Sodium	2 000	25-60	28,500-55,000	66-150
Mercury	3 500 4 000	42-52	12,000-24,000	19-63



Retail/Display



Sports/Floodlighting



High Bay/Industrial

### Major applications

	Retail	Display	Commercial Interior	Sports Lighting	Stadium	High Bay	Industrial	Warehouses	Amenity	Pedestrian Areas	Floodlighting	Security	Street Lighting	Highways	Horticulture
Metal Halide	•	•	•	•	•	•	•	•	•	•	•	•	•		
High Pressure Sodium						•	•	•	•	•	•	•	•	•	•
Mercury								•	•	•	•	•	•	•	



## Choose from a wide selection of GE metal halide lamps.

GE metal halide lamps with their bright, high quality white light and energy-efficiency are ideal for a wide range of applications.

GE makes it easy to choose the right metal halide. Select the right product family for your task and preferred ballast and you will pinpoint the correct lamp for perfect results.

GE's unique 3 part arc tube design provides higher durability that results in excellent reliability.



ConstantColor™ Ceramic Metal Halide

Lamps operate on high pressure sodium / metal halide ballasts incorporating thermal protection (to EN IEC 61167) with metal halide ignitors.



Arcstream™

Lamps operate on high pressure mercury ballasts with metal halide ignitor.



Kolorarc™

Lamps operate on Constant Wattage Gear (CWA).



Multi-Vapor™

Lamps with excellent light output and optical control.



Sportlight™

High quality metal halide light is ideal for illuminating colour critical public spaces such as shopping areas and walkways.

### Applications:

- Retail display
- Decorative and
- Spotlighting of individual features.



## The full line up of metal halide lamps

### Lumen value table (CBCP for PAR/MR16)

Lamp Format	Operating Position	Colour:	20W 3000K	35W 3000K	4200K	70W 3000K	4200K	100W 3000K	150W 3000K	4000K
ConstantColor CMH Ceramic Metal Halide lamps for superior colour control and operating efficiencies										
Super Mini			1615lm	3400lm	3400lm					
Single Ended Mini's	U		1650 lm	3400 lm	3200 lm	6200lm	6200lm			
Single Ended	U		1650 lm	3400 lm	4200 lm	6200lm	6300 lm		14000 lm	13000 lm
Double Ended	HOR			3400 lm	7000 lm	7000 lm	6200 lm		14500 lm	12500 lm
MR16 Spot	U		9000	16000	16000					
MR16 Flood	U		2900	5500	5500					
MR16 W Flood	U		1500	3000	3000					
PAR20 Spot	U		13000	22000	19450					
PAR20 Flood	U		3750	7500	6950					
PAR30 Spot	U		19800	39600	36700	43000				
PAR30 Flood	U		4900	11000	10200	10000				
Elliptical Clear	U				6300 lm			9200 lm		
Elliptical Diffuse	U				6000 lm			8700 lm		12300 lm
Tubular Clear	U				6000 lm			9200 lm	14000 lm	14500 lm
Arcstream™ Lamps operate on high pressure sodium/metal halide ballasts incorporating thermal protection with metal halide ignitor										
Single Ended	U				5200 lm	5200 lm		11500 lm		12000 lm
Double Ended	HOR				5500 lm	5500 lm	5500 lm	12000 lm	12000 lm	12000 lm 11000 lm
Tubular Clear	HOR VBU									
Elliptical Clear	U HOR									
Elliptical Diffuse	U HOR VBU									
Kolorarc™ Lamps operate on high pressure mercury ballasts with metal halide ignitor										
Tubular Clear	HOR VBU									
Elliptical Clear	HOR VBU									
Elliptical Diffuse	HOR VBU									
Multi-Vapor™ Lamps operate on constant wattage gear (CWA)										
Elliptical Clear	U									
Elliptical Diffuse	U VBU									
Multi-Vapor™ High Output More light, longer life										
Elliptical Clear	HOR VBU									
Elliptical Diffuse	HOR VBU									
Sportlight™ For sports and floodlighting										
Linear	HOR									
Tubular Clear	HOR									
Hot Restrike Internal Ignitor										
Elliptical Clear	U									
Elliptical Diffuse	HOR U									
PAR 64	U									
PAR 64 Hot Restrike	U									



## High intensity discharge lamps

# Ceramic Metal Halide-Top performance from GE

With lighting accounting for 20% of the world's energy bill, the pressure is now even greater to minimise its impact on the environment. GE technology has always been at the forefront of CMH lighting, with products that deliver the best possible energy efficiency as well as excellent performance.

CMH offers many desirable lamp features:

- Highly comfortable point source of light
- Long life, and reliability. Excellent colour rendition and colour stability. High efficiency along with superb lumen maintenance
- Instant replacement for less eco-friendly products
- 20% more efficient than quartz metal halide and 4.5 times more efficient than halogen

Wide range of CMH lamps for all kinds of application needs.

- retail
- high & low bay
- commercial lighting
- street lighting, & city beautification
- architectural & floodlighting

## Low watt CMH lamps 20-70W

### Miniature CMH lamps 20-35W

GE's miniature CMH lamps have opened new possibilities for lighting design. Combining the power and light quality of far larger lamps from a tiny capsule, they have made it possible to achieve lighting design that could previously only be obtained with less efficient tungsten halogen.



### Energy efficient lighting solutions

ConstantColor™ CMH 20W, 35W and 70W

- SuperMini
- Ultra
- Precise MR16
- Mini
- Single Ended G12
- Double Ended
- PAR lamps
- Compact Ballast



## High intensity discharge lamps

### CMH Ultra-The next generation

- Excellent color: 930 for G8.5/G12
- Products look more attractive, colors are more vibrant.
- Long life: 15,000 hours  
Up to 6 times the life of halogen lamps, extending relamp cycles and save maintenance costs .
- Improved lumen maintenance: 87% extends service life
- Compatibility: direct replacement for existing 70 watt CMH systems



### High Watt CMH lamps from 100-400 Watts

#### CMH TD Range

New 35W added to 70W and 150W range and 35W allows energy saving in wall-wash fixtures.



#### Single Ended-G12

Extended lamp life up to 60% on 20W, 35W and 70W 3000K lamps and 35W, 70W with 15,000 hours life.



### HID Lamps for street lighting

From roads to parks, play it safe with adjustable outdoor lighting just where you need it. GE's dimmable CMH offers high quality white light that increases safety for both drivers and pedestrians whilst offering the opportunity for dimming during off peak hours.



### Dimmable CMH for street lighting

- Lamp is dimmable to 70% without significant impact to lamp colour
- Lamp is dimmable to 50% without significant impact to lamp reliability and lifetime
- White light standard CRI>65 maintained when 50% dimmed
- Available in 150W 4000K



### CMH 250W

- A leading combination of quality and efficient light versus other HID lamps
- Lamp life – 20,000 hours
- Colour consistency and 80+ CRI



### CMH 400W

- Highest wattage CMH available
- Lamp life – 20,000 hours
- Colour consistency and 80 CRI



## High intensity discharge lamps

### ConstantColor™

Choose ConstantColor™ with metal halide ballasts and ignitors for retail display lighting, high quality exterior floodlighting to obtain crisp, white light.

- Perfect optical control delivering a highly accurate, quality light precisely where you want it
- Long life up to 20,000 hours
- Excellent colour reproduction making it ideal for display lighting
- Good colour consistency throughout life, so your display maintains its features



Single Ended

### Kolorarc™

Choose Kolorarc™ with mercury ballasts and metal halide ignitors for commercial and industrial interiors, shopping malls and floodlighting.

- High brightness – providing high illumination levels even when installed in high ceiling areas
- High energy efficiency – offering maximum energy cost savings
- Excellent colour reproduction providing more attractive lighting environments compared to high pressure sodium and mercury arc lamps



Tubular Clear

### Multi-Vapor™

Choose high output Multi-Vapor™ lamps with constant wattage auto-transformer (CWA) ballasts for large scale commercial and industrial interiors, shopping malls and floodlighting.

- Extra long life – of up to 20,000 hours on CWA gear
- Warm, rich colour – gives merchandise, furnishings and decor added appeal
- High colour temperatures – to blend exceptionally well in mixed applications with incandescent, halogen and warm white fluorescent sources



Elliptical Diffuse

### Sportlight™

Choose Sportlight™ high wattage lamps for sports and floodlighting. The excellent colour rendering and appearance of these lamps makes them especially suitable where television cameras are used.

- Excellent optical control – with minimal beam spread even at long focal lengths
- High output – providing high illumination levels even from high towers
- Excellent colour performance – accurately reproducing colours to create more authentic and attractive floodlit environments



Tubular Clear  
Hot Restrike  
Internal Ignitor



## Metal Halide identification

The following glossary of terms and descriptions can help you when checking metal halide lamp specifications and how to use the order codes when ordering products. Within each product line, lamps are divided into families – within families, lamps are listed by wattage.

**Watts:** Energy used. To find actual energy used (kWh) multiply power (watts shown) x hours of use divided by 1000

**CRI Ra:** Colour rendering index, the higher the number (1–100) the more natural the lit subject appears

**Product Code:** It is important to use this code when ordering to ensure that you receive the exact product you require

### Sportlight™

**Watts**    **Operating position**    **Length mm**    **Order Code**    **Cap**    **CCT K**    **CRI Ra**    **Initial lumens**    **Rated Average Life Hours**    **Pack Qty**    **Product Code**

Hot Restrike 2000	HOR±60°	430	SPL2000/HR/T/H/960/E40	E40	6000	93	170000	5000	4	30104
Internal Ignitor 2000	HOR±60°	430	SPL2000/I/T/H/640/E40	E40	4000	65	190000	2000	4	33148

**Lamp:** Lamp type and product features

**Operating position:** Orientation of lamp

**CCT K:** Colour temperature – Kelvin. The visual warmth or coolness of the light. The higher the number the whiter or cooler the light appears

**Energy Efficiency Class:** Energy saving code

**Rated Average Life:** The point in time when 50% of installed lamps are still burning

### SPL 2000 / I / T / H / 640 / E40

**Family or Feature:**  
ARC: Arcstream™  
CMH: ConstantColor CMH™  
KRC: Kolorarc™  
MPR/MVR: Multi-Vapor™  
MXR: 100W – Arcstream™  
175W – Multi-Vapor™  
SPL: Sportlight™

**Wattage**

**Feature:**  
Missing: no feature  
UVC: UV Control  
I: Internal Ignitor  
E: Enclosed Fixture  
O: Open Fixture  
HR: Hot Restrike

**Lamp Format:**  
TD: Double Ended  
E: Elliptical Clear  
D: Elliptical Diffused  
L: Linear  
PARxx: PAR (+size)  
T: Clear Tubular

**Colour Rendering:**  
6: Ra 58 to 67 (Group 2B)  
7: Ra 68 to 77 (Group 2A)  
8: Ra 78 to 87 (Group 1B)  
9: Ra 88 to 97 (Group 1A)

**Operating Position:**  
Missing: TD – Horizontal;  
PAR – Universal

U: Universal  
H: Horizontal  
VBU: Vertical Base Up  
BU: Base Up

**Colour Temperature:**  
XX: First 2 digits of temperature in Kelvin: xx00k.  
Example: 43 is 4,300 K CCT

**Cap:**  
E27: Fc2  
E40: G38  
RX7s: E39p  
RX7sm: Modified RX7s  
Spec: Special base

# High intensity discharge lamps

## ConstantColor™

Watts	Operating position	Length mm	Order Code	Cap	Colour	Initial lumens/ Candela for PARs, MR16	Rated Average Life V	Rated Avr Life H	Pack Qty	Volts (nominal)	I(A)	Diameter max	Product Code
-------	--------------------	-----------	------------	-----	--------	--	----------------------	------------------	----------	-----------------	------	--------------	--------------

### Single Ended SuperMini



20	U	52	CMH20/TC/UVC/830/GU6.5	GU6.5	830	1615	12000	12000	12	90	0.210	13	40399
35	U	52	CMH35/T/UVC/930/GU6.5	GU6.5	930	3400	10000*	10000*	12	90	0.420	13	88656
35	U	52	CMH35/T/UVC/942/GU6.5	GU6.5	942	3400	12000*	12000*	12	95	0.420	13	88657

\*Initial life claim at launch. Testing continues to final design.

### Single Ended 'Mini's'



20	U	85	CMH20/TC/UVC/U/830/G8.5 PLUS	G8.5	830	1650	12000	12000	12	90	0.225	14.5	39858
35	U	85	CMH35/TC/UVC/U/830/G8.5 PLUS	G8.5	830	3400	15000	15000	12	90	0.5	14.5	43273
35	U	85	CMH35/TC/UVC/U/942/G8.5	G8.5	842	3200	12000	12000*	12	90	0.5	14.5	26348
70	U	85	CMH70/TC/UVC/U/830/G8.5 PLUS	G8.5	830	6200	15000	15000	12	90	0.98	14.5	43274
70	U	85	CMH70/TC/UVC/U/942/G8.5	G8.5	942	6200	15000	15000	12	90	0.98	14.5	26349
70	U	85	CMH70/TC/UVC/U/930/G8.5 ULTRA	G8.5	930	6200	15000	15000	12	95	0.93	14.5	96751

### Single Ended

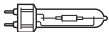

20	U	88	CMH20/T/UVC/U/830/G12 PLUS	G12	830	1650	12000	12000	12	90	0.225	14.5	42708
35	U	88	CMH35/T/UVC/U/830/G12 PLUS	G12	830	3400	15000	15000	12	90	0.5	14.5	43272
35	U	88	CMH35/T/UVC/U/842/G12	G12	842	3200	12000*	12000	12	90	0.5	14.5	92141
70	U	88	CMH70/T/UVC/U/830/G12	G12	830	6200	15000	15000	12	90	0.98	19	20005
70	U	88	CMH70/T/UVC/U/942/G12	G12	942	6300	15000	15000	12	90	0.98	19	20013
70	U	88	CMH70/T/UVC/U/930/G12 ULTRA	G12	930	6400	15000	15000	12	95	0.93	19	96752
150	U	98	CMH150/T/UVC/U/830/G12	G12	830	14000	12000	12000	12	93	1.85	19	20012
150	U	98	CMH150/T/UVC/U/942/G12	G12	942	13000	12000	12000	12	93	1.85	19	20014

### Double Ended

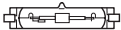

35	HOR±45°	118	CMH35/TD/UVC/830/RX7s	RX7s	830	3400	N/A	10000*	12	90	0.53	21	43278
70	HOR±45°	118	CMH70/TD/UVC/830/RX7s	RX7s	830	6900	N/A	15000	12	90	0.98	21	36910
70	HOR±45°	118	CMH70/TD/UVC/942/RX7s	RX7s	942	6200	N/A	15000	12	90	0.98	21	38698
150	HOR±45°	135	CMH150/TD/UVC/830/RX7s-24	RX7s-24	830	14500	N/A	15000	12	96	1.8	27	36912
150	HOR±45°	135	CMH150/TD/UVC/942/RX7s-24	RX7s-24	942	12500	N/A	15000	12	96	1.8	27	38692

### MR16 Precise

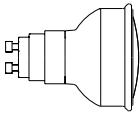

20	U	54.5	CMH20/MR16/UVC/830/GX10/SP	GX10	830	9000	12000	12000	12	95	0.210	51	40400
20	U	54.5	CMH20/MR16/UVC/830/GX10/FL	GX10	830	2900	12000	12000	12	95	0.210	51	40401
20	U	54.5	CMH20/MR16/UVC/830/GX10/WFL	GX10	830	1500	12000	12000	12	95	0.210	51	42691
35	U	54.5	CMH35/MR16/UVC/930/GX10/SP	GX10	930	16000	10000*	10000*	12	90	0.420	51	88658
35	U	54.5	CMH35/MR16/UVC/930/GX10/FL	GX10	930	5500	10000*	10000*	12	90	0.420	51	88659
35	U	54.5	CMH35/MR16/UVC/930/GX10/WFL	GX10	930	3000	10000*	10000*	12	90	0.420	51	88660
35	U	54.5	CMH35/MR16/UVC/942/GX10/SP	GX10	942	16000	12000*	12000*	12	90	0.420	51	88661
35	U	54.5	CMH35/MR16/UVC/942/GX10/FL	GX10	942	5500	12000*	12000*	12	90	0.420	51	88662
35	U	54.5	CMH35/MR16/UVC/942/GX10/WFL	GX10	942	3000	12000*	12000*	12	90	0.420	51	88663

\*Initial life claim at launch. Testing continues to final design.

### PAR 20

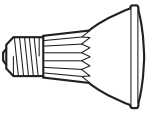

20	U	81.2	CMH20PAR20/UVC/830/E27/SP	E27	830	13000	12000*	12000*	15	90	0.225	63	26478
20	U	81.2	CMH20PAR20/UVC/830/E27/FL	E27	830	3750	12000*	12000*	15	90	0.225	63	26481
35	U	81.2	CMH35/PAR20/UVC/830/E27/SP	E27	830	22000	10000	10000	15	90	0.5	67	21684
35	U	81.2	CMH35/PAR20/UVC/830/E27/FL	E27	830	7500	10000	10000	15	90	0.5	67	21685
35	U	81.2	CMH35/PAR20/UVC/942/E27/SP10	E27	830	19450	10000	10000	15	90	0.5	67	44890
35	U	81.2	CMH35/PAR20/UVC/942/E27/FL25	E27	830	6950	10000	10000	15	90	0.5	67	44919

### PAR 30

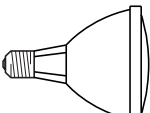

20	U	120	CMH20PAR30/UVC/830/E27/SP10	E27	830	19800	12000*	12000*	6	90	0.5	97	26497
20	U	120	CMH20PAR30/UVC/830/E27/FL25	E27	830	4900	12000*	12000*	6	90	0.5	97	26518
35	U	120	CMH35/PAR30/UVC/830/E27/SP	E27	830	39600	10000	10000	6	90	0.5	97	21689
35	U	120	CMH35/PAR30/UVC/830/E27/FL	E27	830	11000	10000	10000	6	90	0.5	97	21690
35	U	120	CMH35/PAR30/UVC/830/E27/SP	E27	942	36700	10000	10000	6	90	0.5	97	44939
35	U	120	CMH35/PAR30/UVC/830/E27/FL	E27	942	10200	10000	10000	6	90	0.5	97	44942
70	U	120	CMH70/PAR30/UVC/830/E27/SP	E27	830	43000	13000	13000	6	90	0.98	97	21683
70	U	120	CMH70/PAR30/UVC/830/E27/FL	E27	830	10000	13000	13000	6	90	0.98	97	21682

### Elliptical Clear

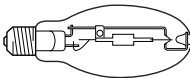

70	U	138	CMH70/E/UVC/U/830/E27/C	E27	830	6300	15000	15000	6	90	0.98	54	46189
100	U	138	CMH100/E/UVC/U/830/E27/C	E27	830	9200	15000	15000	6	100	1.1	54	46191
150	U	138	CMH150/UVC/O/U/942/E27/C	E27	942	13200	15000	15000	6	111	1.8	55	43285

### Elliptical Diffuse



70	U	138	CMH70/E/UVC/U/830/E27/D	E27	830	6000	15000	15000	6	90	0.98	54	46187
70	U	138	CMH70/UVC/O/U/940/E27/D	E27	940	5300	15000	15000	6	90	0.98	54	43282
100	U	138	CMH100/E/UVC/U/830/E27/D	E27	830	8700	10000	15000	6	100	1.1	54	46194
150	U	138	CMH150/UVC/O/U/940/E27/D	E27	940	12300	15000	15000	6	111	1.8	55	43286
250	U	251	CMH250/E/UVC/U/830/E40/D	E40	830	23500	20000	20000	12	125	2.7	90	10591
400	U	282	CMH400/E/UVC/U/830/E40	E40	830/836**	39000	20000	20000	6	110	4.2	120	13087

\*\* 3000K in horizontal burning position, 3600K in vertical burning position

\* Initial life claim at launch, testings are ongoing to final design life.



# High intensity discharge lamps

Watts	Operating position	Length mm	Order Code	Cap	Colour	Initial lumens	Rated Average Life V	Rated Avr Life H	Pack Qty	Volts (nominal)	I (A)	Diameter max	Product Code
Tubular Clear													
70	U	156	CMH70/TT/UVC/830/E27	E27	830	6400	15000	15000	12	105	0.96	37	38752
100	U	209	CMH100/TT/UVC/830/E40	E40	830	9200	10000	15000	12	115	1.14	48	92478
150	U	209	CMH150/TT/UVC/830/E40	E40	830	14000	12000	12000	12	110	1.85	48	38749
150	U	209	CMH150/UVC/T/U/842/E40	E40	842	14500		15000*	12	115	1.8	48	21514
150	U	209	CMH150/UVC/O/T/U/830/E40	E40	830	14000	12000	12000	6	115	1.8	48	21516
150	U	209	CMH150/UVC/O/T/U/942/E40	E40	942	14000	12000	12000	6	110	1.8	48	21517
250	HOR	260	KRC250/CMH/830/T/H/E40	E40	830	20000		20000	12	120	2.3	48	20302
250	U	260	CMH250/TT/UVC/U/830/E40	E40	830	25000	20000	20000	12	125	2.7	48	10589
400	U	278	CMH400/TT/UVC/U/830/E40	E40	830/836**	39000	20000	20000	12	130	4.2	60	13067

\* Initial life claim at launch. Testing continues to final design life.

\*\* 3000K in horizontal burning position, 3600K in vertical burning position

ConstantColor™ CMH lamps operate on high pressure sodium ballast and metal halide ignitor, with the exception of KRC250/CMH/830/T/H/E40 type that operates on mercury or metal halide ballast and metal halide ignitor.

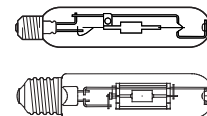

## CMH Ballasts

Watts	Volts	Description	Mounting	Weight	Pack Qty	Product Code
20	120	BLS/E/20W/CMHSMP	Integral - Miniature	110	12	44879
20	220-240	BLS/E/20W/CMHSMP/R	Remote - Miniature	120	12	96804
20	220-240	BLS/E/20W/CMHSMP	Integral	110 g	12	42387
20	220-240	BLS/E/20W/CMH	Integral	190 g	12	13032
20	220-240	BLS/E/20W/CMH/R	Remote	230 g	12	13034
35	220-240	BLS/E/35W/CMH	Integral	215 g	12	13035
35	220-240	BLS/E/35W/CMH/R	Remote	230 g	12	13036
70	220-240	BLS/E/70W/CMH	Integral	300 g	12	13040
70	220-240	BLS/E/70W/CMH/R	Remote	310 g	12	13047
150	220-240	BLS/E/150W/CMH	Integral	430 g	12	13050
150	220-240	BLS/E/150W/CMH/R	Remote	445 g	12	13053

## Arcstream™

Watts	Operating position	Length mm	Order Code	Cap	CCT K	CRI Ra	Initial lumens	Rated Average Life H	Pack Qty	Volts	I (A)	Diameter	Product Code
Single Ended													
70	U	90	ARC70/T/U/730/G12	G12	3000	75	5200	6000	10	N/A	N/A	N/A	35794
70	U	90	ARC70/T/U/842/G12	G12	4200	72	5200	6000	10	N/A	N/A	N/A	35795
150	U	76	ARC150/830/G12	G12	3000	80	11500	6000	10	N/A	N/A	19	88654
150	U	76	ARC150/842/G12	G12	4200	80	12000	6000	10	N/A	N/A	19	88655
Double Ended - UV Control													
70	HOR±45°	117.6	ARC70/UVC/TD/730/Rx7s	Rx7s	3000	75	5500	6000	12	95	0.95	22	34530
70	HOR±45°	117.6	ARC70/UVC/TD/742/Rx7s	Rx7s	4200	75	5500	6000	12	95	0.95	22	34536
150	HOR±45°	135.4	ARC150/UVC/TD/732/Rx7s-24	Rx7s-24	3200	75	12000	6000	12	95	1.8	25	34527
150	HOR±45°	135.4	ARC150/UVC/TD/742/Rx7s-24	Rx7s-24	4200	75	12000	6000	12	95	1.8	25	34535
Double Ended													
150	HOR±45°	135.4	ARC150/TD/952/Rx7s-24	Rx7s-24	5200	90	11000	6000	12	110	1.8	22	93772
150	HOR±45°	135.4	ARC150/UVC/AQUA/TD/865/Rx7s-24	Rx7s-24	6500	85	11000	6000	12	95	1.8	25	35284
250	HOR±45°	163	ARC250/TD/832/Fc2	Fc2	3200	80	20000	6000	12	114	3	25	30099
250	HOR±45°	163	ARC250/TD/842/Fc2	Fc2	4200	80	20000	6000	12	115	3	25	30101

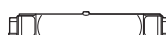
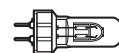

Watts	Operating position	Length mm	Order Code	Cap	CCT K	CRI Ra	Initial lumens	Rated Average Life H	Pack Qty	Volts	I (A)	Diameter	Product Code
Double Ended Coloured													
150	HOR±45°	132	ARC150/UVC/TD/GREEN/RX7S-24	RX7S-24	Green	N/A	N/A	6000	12	95	1.8	25	12181
150	HOR±45°	132	ARC150/UVC/TD/BLUE/RX7S-24	RX7S-24	Blue	N/A	N/A	6000	12	95	1.8	25	12182
150	HOR±45°	132	ARC150/UVC/TD/ORANGE/RX7S-24	RX7S-24	Orange	N/A	N/A	6000	12	95	1.8	25	12183
150	HOR±45°	132	ARC150/UVC/TD/MAGENTA/RX7S-24	RX7S-24	Magenta	N/A	N/A	6000	12	95	1.8	25	12184



Tubular Clear													
250	BU±45°	219	ARC250/T/VBU/960/E40	E40	6000	90	19000	10000	12	100	3	47	32665
250	HOR±45°	219	ARC250/T/H/960/E40	E40	6000	90	19000	10000	12	100	3	47	32664
400	HOR±15°	260	ARC400/T/H/742/E40	E40	4200	70	35000	10000	10	105	4.35	46	42369

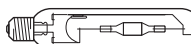

Elliptical Clear													
250	NDL	227	ARC250/E/H/645/E40	E40	4500	65	22500	14000	10	100	2.9	91	16869

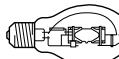

Elliptical Diffuse													
250	HOR±15°	227	ARC250/D/H/740/E40	E40	4000	70	19500	14000	10	100	2.9	91	16870
250	HOR±45°	227	ARC250/D/H/960/E40	E40	6000	90	17000	10000	12	100	3	90	30047
250	BU±45°	227	ARC250/D/VBU/960/E40	E40	6000	90	17000	10000	12	100	3	90	32666

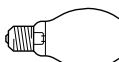

Operating from suitable metal halide / high pressure sodium (HPS) ballast and metal halide ignitor. Arcstream™ lamps are only suitable for operation in fully enclosed fixtures where lens/diffuser material must be able to contain fragments of hot quartz or glass (up to 1100 °C)

# High intensity discharge lamps

## Kolorarc™

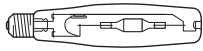

Watts	Operating position	Length mm	Order Code	Cap	CCT K	CRI Ra	Initial lumens	Rated Average Life H	Pack Qty	Volts	I (A)	Diameter	Product Code
400	HOR±45°	270	<b>KRC400/T/H/960/E40</b>	E40	6000	90	25000	10000	12	130	3.5	59	<b>30052</b>
400	BU±45°	270	<b>KRC400/T/VBU/960/E40</b>	E40	6000	90	28000	10000	12	130	3.5	59	<b>30704</b>

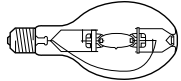

400	BU±30°	286	<b>KRC400/E/VBU/645/E40</b>	E40	4500	65	32000*	14000	10	135	3.5	122	<b>16871</b>
-----	--------	-----	-----------------------------	-----	------	----	--------	-------	----	-----	-----	-----	--------------

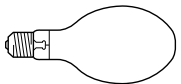

Elliptical Diffuse													
400	BU±30°	286	<b>KRC400/D/VBU/740/E40</b>	E40	4000	70	30500*	14000	10	135	3.5	122	<b>16872</b>
400	HOR±15°	286	<b>KRC400/D/H/740/E40</b>	E40	4000	70	34000	14000	10	135	3.5	122	<b>16875</b>
400	BU±45°	282	<b>KRC400/D/VBU/960/E40</b>	E40	6000	90	26000	10000	4	130	3.5	121	<b>10837</b>
400	HOR±45°	281	<b>KRC400/D/H/960/E40</b>	E40	6000	90	24000	10000	4	130	3.5	121	<b>10834</b>

Operating from suitable mercury or metal halide ballast rated 3.5A and metal halide ignitor. Low loss ballast recommended for 400W 6000K (960) products – see lamp data sheet for details.

\* Enhanced lumen performance operating from special "High Output" ballast rated 3.8A – see lamp data sheet for details. Kolorarc™ lamps are only suitable for operation in fully enclosed fixtures where lens/diffuser material must be able to contain fragments of hot quartz or glass (up to 1100 °C)

## Multi-Vapor™

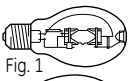

Watts	Operating position	Length mm	Order Code	Cap	CCT K	CRI Ra	Initial lumens	Rated Average Life Hours	Rated Average V	Pack Qty	Volts	I (A)	Diameter Code	Product Fig No.
-------	--------------------	-----------	------------	-----	-------	--------	----------------	--------------------------	-----------------	----------	-------	-------	---------------	-----------------

Elliptical Clear														
250	U	216	<b>MVR250/U/40</b>	E40	4200	65	20800	10000	10000	12	135	2.1	89	<b>44542</b> 1
400*	U	295	<b>MVR400/U/40</b>	E40	4000	65	36000	20000	20000	6	135	3.2	117	<b>43907</b> 2
1000*	U	385	<b>MVR1000/U/40</b>	E40	4000	65	105000	12000	12000	6	V250 H245	4.3	178	<b>41828</b> 3

Elliptical Diffuse														
250	U	216	<b>MVR250/C/U/40</b>	E40	3900	70	19800	10000	10000	12	133	2.1	89	<b>44543</b> 4
400*	U	295	<b>MVR400/C/U/40</b>	E40	3700	70	35000	20000	20000	6	135	3.2	117	<b>43908</b> 5
1000*	U	385	<b>MVR1000/C/U/40</b>	E40	3400	70	99800	12000	12000	6	V250 H245	4.3	178	<b>41829</b> 6

Operating from CWA control gear

Initial lumen values and Rated Average Life based on vertical orientation for Universal types. Multi-Vapor™ lamps must operated in fully enclosed fixtures except those marked \*when used VBU or VBD +/-15°.

For lamps requiring enclosed fixtures, lens/diffuser material must be able to contain fragments of hot quartz or glass (up to 1100 °C)

Lamps operated in the vertical position that are not designated "Enclosed Fixtures only" lamp may be used in an open or enclosed lighting fixture depending upon the application and operating environment.

For example, if the lamp is located near combustible material or in an area which is unoccupied for extended periods, an enclosed fixture which can contain fragments of hot quartz or glass is recommended. For more information contact your fixture manufacturer.

## Multi-Vapor™ High Output

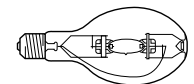

Watts	Operating position	Length mm	Order Code	Cap	CCT K	CRI Ra	Initial lumens	Rated Average Life H	Pack Qty	Volts	I (A)	Diameter	Product Code
-------	--------------------	-----------	------------	-----	-------	--------	----------------	----------------------	----------	-------	-------	----------	--------------

Elliptical Clear													
400	VBU±15°	295	<b>MVR400/VBU/40</b>	E40	4000	65	40000	20000	6	135	3.2	117	<b>49860</b>
400*	VBU±15°	292	<b>MPR400/VBU/0/40</b>	E40	3400	65	38000	20000	6	-	-	-	<b>18709</b>

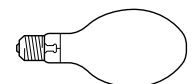

Elliptical Diffuse													
400		295	<b>MVR400/C/VBU/40</b>	E40		70	37600	20000	6	-	-	-	<b>49857</b>
400*	VBU±15°	292	<b>MPR400/C/VBU/0/40</b>	E40	3000	70	37600	20000	6	-	-	-	<b>27738</b>

Operating from CWA control gear

Initial lumen values and Rated Average Life based on vertical orientation for Universal types. Multi-Vapor™ lamps must operated in fully enclosed fixtures except those marked \*when used VBU or VBD +/-15°.

For lamps requiring enclosed fixtures, lens/diffuser material must be able to contain fragments of hot quartz or glass (up to 1100 °C)

Lamps operated in the vertical position that are not designated "Enclosed Fixtures only" lamp may be used in an open or enclosed lighting fixture depending upon the application and operating environment.

For example, if the lamp is located near combustible material or in an area which is unoccupied for extended periods, an enclosed fixture which can contain fragments of hot quartz or glass is recommended.

For more information contact your fixture manufacturer.



## Sportlight™

Watts	Operating position	Length mm	Order Code	Cap	CCT K	CRI Ra	Initial lumens	Rated Average Life H	Pack Qty	Volts	I (A)	Diameter	Product Code
Linear													
1500	HOR±15°	256	SPL1500/L/H/652/Rx7SM	Rx7SM	5200	65	120000	6000	1	270	6.8	24.3	16920
2000	HOR±15°	311	SPL2000/L/H/654/spec	spec.	5200	65	200000	6000	1	250	10.3	26	16922
Tubular Clear													
1000	HOR±60°	340	SPL1000/T/H/960/E40	E40	6000	90	80000	8000	4	130	9.5	81	20106
2000	HOR±60°	430	SPL2000/T/H/960/E40	E40	6000	93	170000	5000	4	250	10.3	101.5	30102
2000	HOR±75°	430	SPL2000/220/T/H/640/E40	E40	4000	65	180000	2000	-	135	16.5	101.5	178554
Tubular Clear Coloured													
2000	HOR±75°	430	HgMI 2000W/220V Ga	E40	Blue	N/A	N/A	2000	-	135	16.5	101.5	178554
Internal Ignitor													
2000	HOR±75°	430	SPL2000/I/T/H/640/E40	E40	4000	65	190000	2000	4	250	8.8	101.5	33148
2000	HOR±60°	430	SPL2000/I/T/H/960/E40	E40	6000	93	170000	5000	4	250	10.3	101.5	30103
strictly for use without starting device													
Elliptical Diffuse													
2000		430	MBI2000/T	E40	-	90	210000	3000	4	-	-	-	32104
PAR 64													
1000	HOR±90°	175	CSI/PAR64/G38	G38	4000	80	76000	3500	1	77.5	14.7	205	29333
1000	HOR±90°	175	CSI/PAR64/HR/G38	G38	4000	80	76000	3500	1	77.5	14.7	205	29336

Please refer to technical catalogue/data sheet for appropriate ballast and ignitors. Sportlight™ lamps are only suitable in fully enclosed fixtures, where fixture lens/diffuser material must be able to contain fragments of hot quartz or glass (up to 1100 ° C)

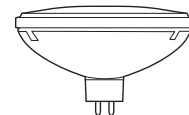
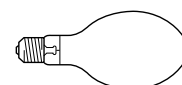
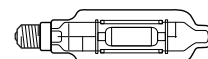
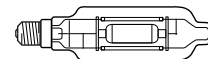

## High intensity discharge lamps

### Lucalox™ Standard

#### The highly efficient, long life lamp

- Ideal for streetlighting, commercial and industrial use
- Wide range of wattages and sizes
- Up to 28,500 hours life
- Highly efficient, producing 130 lumens per watt

### Lucalox™ XO, PSL

#### The extra high output and long life lamp

- Extra light – up to 20% more lumens
- Long life of up to 32,000 hours
- Highly efficient, producing 150 lumens per watt
- PSL is ideal for Horticulture Lighting

### Lucalox™ Internal Ignitor

#### The efficient compact solution with built in ignitor

- Simple – luminaires only need regular HPS ballast, simpler luminaire designs can be used
- Efficiency and long life from a simple and versatile retrofit lamp
- Compact – enables use of small fixture lighting systems

### Lucalox™ TD (Double-ended)

#### Lucalox™ efficiency in an ultra compact size

- Compact size – small size fits ultra compact fixtures
- Excellent optical control – delivers a concentrated beam of light exactly where needed
- High efficiency - up to 137 lumens per watt
- Long life - 20,000 hours

### Lucalox™ E-Z Lux™

#### Converts mercury sockets to highly efficient high pressure sodium lighting

- Direct replacement for mercury lamps – operates on mercury ballasts
- More efficient, higher lumens than mercury
- 14% energy cost savings
- 40%+ more light

### Lucalox™ Superlife

#### Extra arc tube provides light instantly after power interruption

- “Superlife” arc tube provides light instantly after momentary power interruption, and will increase to full output in 1-2 minutes
- Longest life – dual arc tubes provide up to 55,000 hour rated life



## High Pressure Sodium identification

The following glossary of terms and descriptions can help you when checking high pressure sodium lamp specifications and explains how to use the order codes when ordering products. Within each product line, lamps are divided into families – within families, lamps are listed by wattage.

**Watts:** Energy used. To find actual energy used (kWh) multiply power (watts shown) x hours of use divided by 1000

**Length:** Lamp length in mm

**Cap:** The type of cap fitted

**CRI Ra:** Colour rendering index, the higher the number (1-100) the more natural the lit subject appears

**Product Code:** It is important to use this code when ordering to ensure that you receive the exact product you require

**Initial Lumens:** Light output at 100 hours

**Product Description/Order code:** The lamp's identification code

**Lucalox™**

Watt	Operating position	Length mm	Order Code	Cap	CRI Ra	Initial lumens	Rated Average Life Hours	Pack Qty	Product Code
Lucalox™ T – Tubular Clear. 2000K – E									
50	U	156	LU50/85/T/27	E27	25	3400	28500	25	22445
70	U	156	LU70/90/T12/27	E27	25	6000	28500	25	22452

**Lamp:** Lamp type and product features

**Operating position:** Orientation of lamp

**Product Family:** LU – Lucalox™

**Wattage**

**Feature:** Identifies product feature or operating voltage

**Bulb Format:** TD: Double Ended  
E: Elliptical  
D: Elliptical Diffuse  
T: Single Ended Tubular  
RFL: Reflector

**Cap Description:** E27 E40 RX7s-24

**Rated Average Life:** The point in time when 50% of installed lamps are still burning

**Pack Quantity:** The number of lamps in one box



Donghai Bridge in Shanghai installed with Standby 250W HPS lamps

## High intensity discharge lamps

# Lucalox™ XO Photosynthesis Light Lamp (PSL)

Low operating costs, long useful life, energy-efficient performance



Lucalox™ T



Lucalox™ E

- High efficiency – up to 150 lumens per watt – converting more energy into light, cutting energy and operating costs
- Outstanding life – up to 55,000 hours substantially reducing lamp maintenance and replacement costs
- Lamps that start bright and stay that way, offering high maintained lumens over life

### Lighting for Horticulture

Specially developed for greenhouses, the Lucalox™ PSL offers the twin benefits of stable lumen maintenance and a full spectrum content that promotes photosynthesis.



## Lucalox™

Watt	Operating position	Length mm	Order Code	Cap	CRI Ra*	Initial lumens	Rated Average Life H	Pack Qty	Volts	I (A)	Diameter	Product Code
Lucalox™ T – Tubular Clear. 2000K												
50	U	156	LU50/85/MO/T/E27 1/25	E27	25	3400	28500	25	85	0.76	38.5	88553
70	U	156	LU 70/90/MO/T/E27 1/25	E27	25	6000	28500	25	90	0.98	38.5	46221
100	U	211	LU100/100/MO/T/40	E40	25	9600	28500	12	100	1.2	48	93767
150	U	211	LU150/100/40	E40	25	15000	28500	12	100	1.8	48	44244
250	U	260	LU250/T/40	E40	25	27500	28500	12	100	3	48	22453
400	U	283	LU400/T/40	E40	25	48000	28500	12	100	4.6	48	11678
1000	U	372	LU1000/110/T/40 4pk	E40	25	130000	24000	4	110	10.6	67	45751



Watt	Operating position	Length mm	Order Code	Cap	CRI Ra*	Initial lumens	Rated Average Life H	Pack Qty	Volts	I (A)	Diameter	Product Code
Lucalox™ E – Elliptical Diffuse. 2000K												
50	U	156	LU50/85/MO/D/E27 1/25	E27	25	3300	28500	12	85	0.76	72	88554
70	U	156	LU 70/90/MO/D/E27 1/12	E27	25	5800	28500	12	90	0.98	72	46217
100	U	211	LU100/100/MO/D/40	E40	25	9200	28500	12	100	1.2	76	93766
150	U	227	LU150/100/D/40	E40	25	14500	28500	12	100	1.8	91	44245
250	U	227	LU250/D/40	E40	25	26000	28500	12	100	3	91	44052
400	U	282	LU400/D/40	E40	25	48000	28500	6	100	4.45	122	44057
1000	U	372	LU1000/110/D/40	E40	25	120000	24000	1	110	10.3	161	30228

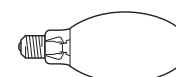

I – Internal Starter; E – External Starter  
\*Nominal, reference only

Watt	Operating position	Length mm	Order Code	Cap	CCT K	CRI Ra*	PAR mmol/sec	Initial lumens	Rated Average Life H	Pack Qty	Volts	I (A)	Diameter	Product Code
------	--------------------	-----------	------------	-----	-------	---------	--------------	----------------	----------------------	----------	-------	-------	----------	--------------

Lucalox™ XO – (Xtra Output) Tubular Clear														
50	U	156	LU50/85/XO/T/27	E27	2100	25	-	4400	28500	25	85	0.76	38.5	93373
70	U	156	LU70/90/XO/T/27	E27	2100	25	-	6600	28500	25	90	0.98	38.5	93375
100	U	211	LU100/100/XO/T/40	E40	2100	25	-	10700	28500	12	100	1.2	48	93376
150	U	211	LU150/150/XO/T/40	E40	2100	25	-	17500	32000	12	100	1.8	48	93377
250	U	260	LU250/XO/T/40	E40	2100	25	-	33000	32000	12	100	2.95	48	93378
400	U	283	LU400/XO/T/40	E40	2100	25	-	56500	32000	12	100	4.5	48	93269
600	U	283	LU600/XO/T/40	E40	2100	25	-	90000	32000	12	115	6	48	93270

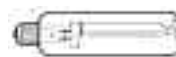

Lucalox™ XO – (Xtra Output) Elliptical Diffuse														
50	U	156	LU50/85/XO/D/27	E27	2100	25	-	3600	28500	12	85	0.76	72	45696
70	U	156	LU70/90/XO/D/27	E27	2100	25	-	6000	28500	12	90	0.98	72	45697
100	U	186	LU100/100/XO/D/40	E40	2100	25	-	10000	28500	12	100	1.2	76	93379
150	U	227	LU150/100/XO/D/40	E40	2100	25	-	16900	32000	12	100	1.8	91	93380
250	U	227	LU250/XO/D/40	E40	2100	25	-	31200	32000	12	100	2.95	91	93381
400	U	282	LU400/XO/D/40	E40	2100	20	-	54000	32000	12	105	4.4	122	93296

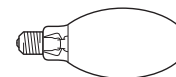

### Lighting For Horticulture

Lucalox™ PSL – (PhotoSynthesis Light) Tubular Clear														
400	U	283	LU400 PSL/T/E40	E40/45	2100	22	725	56500	10000	12	110	4.3	48	17106
600	U	283	LU600 PSL/T/E40	E40/45	2100	22	1100	90000	10000	12	115	6	48	17107
750	U	293	LU750 PSL/T/E40	E40/45	2100	25	1350	112000	10000	12	115	7	51	17108
600	U	283	LU400V/600W/PSL/T/E40	E40/45	2100	22	1150	85000	10000	12	200	3.6	48	23440
750	U	293	LU400V/750W/PSL/T/E40	E40/45	2100	25	1415	104000	10000	12	205	4.4	51	23433

New Improved 400V lamps available with Bulk pack option.

LU400V/750W/PSL/T/2/E40 Bulk 1/45	43437
LU400V/750W/PSL/T/2/E40 1/12	43438
LU400V/600W/PSL/T/2/E40 Bulk 1/45	43439
LU400V/600W/PSL/T/2/E40 1/12	43440

Internal Starter; E – External Starter

High pressure sodium lamps operating from HPS ballast and HPS ignitor

\*Nominal, reference only

⚡ \*External ignitor

⚡ Internal ignitor

## GE Lucalox™ XO Lamp

The new Zirconium in the lamp ensures a higher quality of vacuum in the outer bulb than with other getter systems.

The new GE Reliable Starting Technology, GRS, improves the starting characteristics by permanently bonding an electrically conductive ceramic to the arc tube surface.

Higher transparency ceramic for improved light output!

Monolithic construction: a totally new arc tube concept for higher reliability. The body and the end plug is now a single unit. GE "XO" lamps always retain the sodium amalgam at the monolithic end. This feature reduces the undesirable chemical reactions and end blackening.

# High intensity discharge lamps

## Lucalox™ continued

Watt	Operating position	Length mm	Order Code	Cap	CRI Ra	Initial lumens	Rated Average Life H	Pack Qty	Volts	I (A)	Diameter	Product Code
Lucalox™ TD - Double Ended												
250	HOR±20°	191	LU250/TD	Rx7s-24	25	23000	20000	10	100	2.95	22.4	30241
400	HOR±20°	256	LU400/TD	Rx7s-24	25	43000	20000	10	100	4.4	22.4	30244
1000	HOR±20°	334	LU1000/TD	Rx7s-24	25	137000	20000	10	250	4.7	22.4	30246
Lucalox™ E-Z Lux™ - Direct replacement for mercury lamps - Operates from mercury ballasts												
Elliptical Diffuse												
110	U	175	LUH110/D/27-SHx	E27	25	8800	16000	40	-	-	75	39512
Lucalox™ I - Elliptical Clear												
70	U	156	LU 70/90/MO/I/E27 1/12	E27	25	6000	12000	12	90	0.98	72	46209
Lucalox™ I - Elliptical Diffuse												
50	U	156	LU50/85/MO/D/I/E27 1/12	E27	25	3300	12000	12	85	0.76	72	88556
70	U	156	LU70/90/MO/D/I/E27 1/12	E27	25	5800	12000	12	90	0.98	72	46186
Lucalox™ Superlife/Standby - Tubular Clear												
50	U	156	LU50/85/MO/SBY/T/E27 1/25	E27	25	3400	40000	25	85	0.76	38.5	88558
70	U	156	LU70/90/MO/SBY/T/E27 GE 1/25	E27	25	6000	40000	25	90	0.98	38.5	88268
70	U	156	LU 70/XO/SBY/T/E27	E27	25	6600	40000	25	90	0.98	71	88258
100	U	211	LU 100/XO/SBY/T/E40	E40	25	10500	55000	12	100	1.2	75	88256
100	U	211	LU100/100/MO/SBY/T/40	E40	25	9600	50000	12	100	1.2	48	17899
150	U	211	LU150/100/SBY/T/40	E40	25	15000	50000	12	100	1.8	48	35594
250	U	260	LU250/SBY/T/40	E40	25	27500	55000	12	100	3	48	35586
400	U	283	LU400/SBY/T/40	E40	25	50000	55000	12	100	4.6	48	35582
Lucalox™ Superlife/Standby - Elliptical Diffuse												
50	U	156	LU50/85/MO/SBY/D/E27 1/25	E27	25	3300	40000	12	85	0.76	72	88557
70	U	156	LU70/90/MO/SBY/D/E27 GE 1/12	E27	25	5800	40000	12	90	0.98	72	88269
70	U	156	LU 70/XO/SBY/D/E27	E27	25	6000	40000	25	90	0.98	71	88257
100	U	186	LU 100/XO/SBY/D/E40	E40	25	10000	55000	12	100	1.2	75	88255
100	U	211	LU100/100/MO/SBY/D/E40 GE 1/12	E40	25	10000	55000	12	115	1.2	75	88255
150	U	227	LU150/100/SBY/D/40	E40	25	14500	50000	12	100	1.8	91	35589
250	U	227	LU250/SBY/D/40	E40	25	26000	55000	12	100	3	91	35590
400	U	282	LU400/SBY/D/40	E40	25	47500	55000	6	105	4.45	122	35591

I - Internal Starter, E - External Starter

External Ignitor required

Internal Ignitor

### GE Lucalox™ Lamp

- **Nickel Alloy Cap**  
Corrosion free, good electrical contact throughout life and moisture damage is eliminated
- **High maintained light output**
- **Shorter re-strike time**  
Than either metal halide or mercury lamps
- **Starts and operates at temperatures as low as -40°C**
- **Provides a warm golden light**
- **Average rated life of up to 28,500Hrs**  
Increased to 55,000 for Superlife versions. Offering lower replacement costs

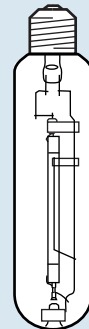

- **Lamp Cap Identification**  
Helps measure the lamp's performance over time

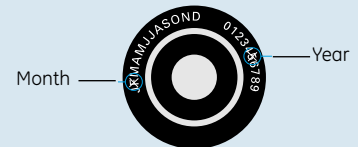

- **Clean Arc Tube**
- **Highest efficiency/lowest operating costs among the High Intensity Discharge (HID) product range with acceptable colour rendering**



## Mercury

High quality colour from a versatile range of lamps

- Ideal for commercial, industrial and outdoor applications with a wide choice of lamp types and ratings
- Good colour rendering
- Modest installation and running costs



Kolorlux™

### Mercury lamp types:

**Kolorlux Standard** – Traffic and industrial lamps.

**Blended Light** – An alternative to incandescent requiring no control gear and giving warm white light with good energy efficiency.

## Mercury identification

The following glossary of terms and descriptions can help you when checking mercury lamp specifications and explains how to use the order codes when ordering products. Within each product line, lamps are divided into families – within families, lamps are listed by wattage.

**Watts:** Energy used. To find actual energy used (kWh) multiply power (watts shown) x hours of use divided by 1000

**Length:** Lamp length in mm

**Product Description/Order code:** The lamp's identification code

**Cap:** The type of cap fitted

**Initial Lumens:** Light output at 100 hours

**CRI Ra:** Colour rendering index, the higher the number (1–100) the more natural the lit subject appears

**Product Code:** It is important to use this code when ordering to ensure that you receive the exact product you require

### Mercury – Operating on mercury ballast

Watt	Operating position	Length mm	Order Code	Cap	CRI Ra	Initial lumens	Rated Average Life H	Pack Qty	Volts	I (A)	Diameter	Product Code
Kolorlux Standard (MBF)												
80	U	166	H80/27 START 1/24	E27	40	3600	12000	24	130	0.80	71	44182
125	U	178	H125/E27/GE/START	E27	40	5800	12000	24	140	1.15	76	44180
250	U	228	H250/E40/GE/START 1/12	E40	40	12000	12000	12	145	2.15	91	42713

**Lamp:** Lamp type and product features

**Operating position:** Orientation of lamp

**Lamp Type:** H: Mercury lamp

**Wattage:** 125

**Cap Description:** E27 E40 BV22d B22d-3

**Pack Quantity:** The number of lamps in one box

**Rated Average Life:** The point in time when 50% of installed lamps are still burning

### Mercury – Operating on mercury ballast

Watt	Operating position	Length mm	Order Code	Cap	CRI Ra	Initial lumens	Rated Average Life H	Pack Qty	Volts	I (A)	Diameter	Product Code
Kolorlux Standard (MBF)												
80	U	166	H80/27 START	E27	40	3600	12000	24	130	0.80	71	44182
125	U	178	H125/E27/GE/START	E27	40	5800	12000	24	140	1.15	76	44180
125	U	170	H125/27 1/24 MIC	E27	40	6300	20000	24	140	1.15	76	73736
250	U	228	H250/E40/GE/START	E40	40	12000	12000	12	145	2.15	91	42713
250	U	227	H250/40 1/12	E40	40	13000	20000	12	145	2.15	91	73737
400	U	292	H400/40 START	E40	40	20000	12000	12	150	3.25	122	44185
400	U	292	H400/40 START1	E40	40	20000	12000	12	150	3.25	122	45170

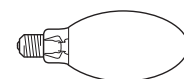

### Blended Light (MBTF)

160	VER±30°	170	ML 160/ 230–240V, E27	E27	52	3100	8000	40	230–240	0.73	76	85954
160	VER±30°	170	ML 160/ 230–240V, B22	B22	52	3100	8000	40	230–240	0.7	76	85954
160	VER±30°	170	ML 160/ 240–250V, E27	E27	52	3100	8000	40	230–240	0.7	76	85965
250	VER±30°	227	ML 250/ 230–240V, E40	E40	52	5600	8000	12	230–240	1.17	90	85948
250	VER±30°	227	ML 250/ 230–240V, E27	E27	52	5600	8000	12	230–240	1.17	90	85955
250	U*	227	ML 250/ 240–250V, E40	E40	52	5600	8000	12	230–240	1.08	90	85962
500	U*	292	ML 500/ 230–240V, E40	E40	52	14000	8000	10	230–240	2.35	120	85904

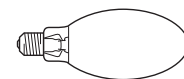

\*Operating position universal but optimum orientation VER ± 45°.

# High intensity discharge lamps

## Discharge lamps

### Run-up and re-strike time

When a discharge lamp is switched-on, current flows through gas in the arc tube and the power dissipated generates heat vaporising the mercury, sodium or halide filling until stable electrical operating conditions are achieved. This is known as the run-up or warm-up period. The run-up period can be several minutes until the lamp stabilises and achieves published lumen output and colour performance. Run-up value shown in the table is the time taken for the lamp to reach 90% of final light output.

Re-strike time is based on lamps that have fully run-up and then a momentary break in the supply voltage occurs causing extinction.

Actual run-up time and re-strike time will vary according to application, type of fitting used, factors affecting warm-up/cooling rate of the lamp and the ambient temperature.

Most discharge lamps other than high pressure mercury and Multi-Vapor™ are started by a high voltage pulse generated by a separate ignitor, which automatically switches-off after the lamp has started. Use of an external electronic starting device simplifies lamp construction and provides reliable starting performance.

Lamp	Rating (watts)	Run-up time (minutes)	Re-strike time (minutes)	Lamp	Rating (watts)	Run-up time (minutes)	Re-strike time (minutes)
Arcstream™ Single Ended	70	1.5	3-5	Lucalox™	50	4	less than 1
	150	1	3-5		70	4	less than 1
Double Ended	70	3	5-10		100	4	less than 1
	150	3	5-10		150	4	less than 1
Elliptical	250	4	5-10		250	5	less than 1
	100	3	5-10		400	3	less than 1
Tubular	250	2-4	5-10	1000	6	less than 1	
	400	2.5	5-10	Kolorlux	50	6	4-7
Kolorarc™ Elliptical	400	3-4	5-10	80	5	4-7	
	400	4	5-10	125	5	4-7	
Multi-Vapor™	175	3	10-15	250	5	4-7	
	250	3	10-15	400	5	4-7	
	400	3	10-15	700	5	4-7	
	1000	3	10-15	1000	5	4-7	
Sportlight™ Elliptical	1000	2-4	5-15				
	750	2	15-20				
	1000	2	15-20				
	1500	2	15-20				
	2000	2	15-20				
	Tubular	1000	4	5-15			
	2000	4	5-15				
PAR	1000	1	10				

Notes:  
1 In Floodlight  
2 Hot Re-strike version also available



## General information

### Life of HID lamps

All life ratings for GE high intensity discharge lamps are expressed in terms of 'Rated Average Life', quoted in hours, where average is the 'median' value. This means the number of burning hours until 50% of lamps in an installation (of at least 30 lamps) are expected to have failed or not be operating to the published performance specification. Life ratings are based on lamps operating from suitable control gear for at least ten hours per switching. Lamps operating less than ten hours per start will have a reduced Rated Average Life (typically 25% reduction for each burning cycle reduction of 50%).

### Ambient operating temperature

GE Lighting discharge lamps will start reliably at an ambient temperature down to -40°C for Lucalox™ high pressure sodium, -30°C for metal halide and -20°C for high pressure mercury.

### Supply Voltage

Discharge lamps in this catalogue are suitable for supplies in the range 220V to 250V 50/60Hz (or 380V to 440V for some Sportlight™ products) when using suitably rated electromagnetic or electronic control gear. Supplies outside this range require a transformer (conventional, high reactance or CWA) or an electronic ballast to ensure correct lamp operation.

Lamps start and operate at 10% below rated supply voltage when the correct control gear is used. However, in order to maximise lamp survival, lumen maintenance and colour uniformity the actual supply voltage and ballast design voltage should be within  $\pm 3\%$ . Supply variations up to  $\pm 5\%$  are acceptable for short periods only; otherwise lamp life and/or performance will be adversely affected.

Measuring mean supply voltage at the installation and selecting the appropriate ballast setting/tapping is the recommended method of matching multi-voltage rated ballasts to actual supply voltage.

### Regular switching of lamps

Continuous operation of mercury and metal halide lamps can increase the slight risk that lamps may shatter, particularly if run beyond rated-life. It is recommended, particularly towards rated end-of-life, that lamps are switched-off for 15 minutes at least once in every 24 hour period to minimise the risk of such failure.

Most metal halide lamps must be fully enclosed within a luminaire to ensure retention of any fragments in the event of a shattering failure mode - see lamp data sheets for details.

### Circuit Fusing

Recommended HBC fuse and MCB ratings for discharge lamps are given in lamp technical data sheets and publication 'Fuse Ratings for Discharge Lamps', available from GE Lighting.

### Further information

Technical data sheets provide more detailed technical information for the products listed. Contact GE Lighting Customer Service or local sales office to obtain copies.

GE Lighting has been a leading supplier to Entertainment and Specialty lamp users for many decades and continues its pioneering work in the development of new and innovative light sources.

Entertainment lamps are being sold under the SHOWBIZ® brand. GE Lighting continues to provide lamps for stage, studio, nightclub and theatre lighting, to architectural and fiber optic lighting applications for this segment.





## Content

PAR Lamps	126
Single Ended Halogen Lamps	129
Linear Halogen Lamps	133
Specialist Projector Lamps	135
Discharge Lamps	139
Explanation of codes	143
Glossary of basic product information	144

## SHOWBIZ® identification

The following glossary of terms and descriptions can help you when checking SHOWBIZ® lamp specifications and when ordering products. Within each product line, lamps are divided into families - within these families, lamps are listed by wattage..

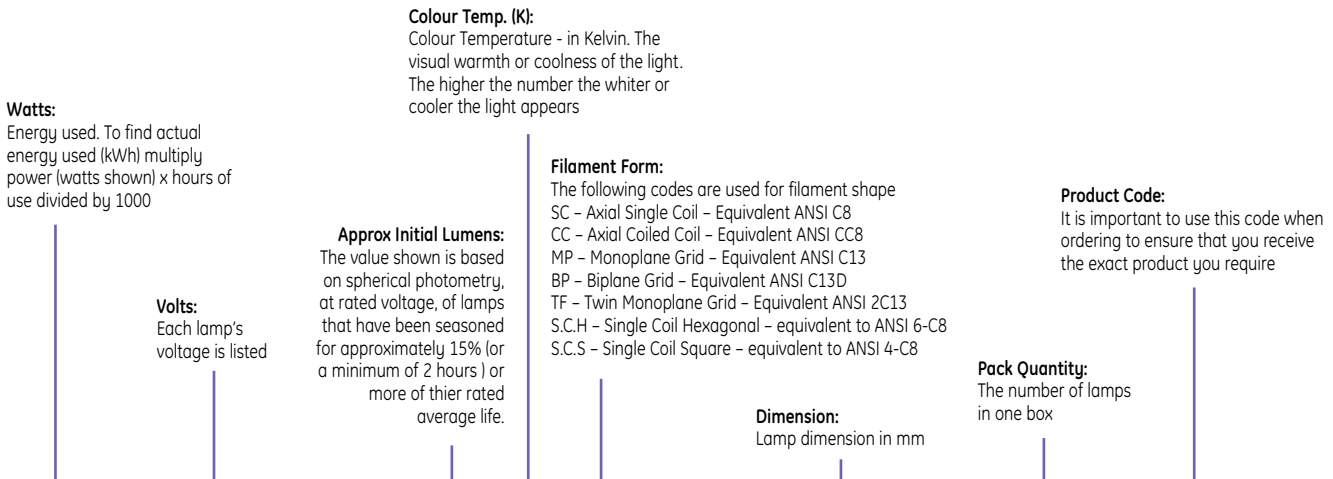

### Single Ended Halogen

Watt	Volt	Ansi Code	LIF Code	Lumen	CCT K	Filament	Fila. H x W	Dimension A	Dim. B	Dim. C	Life (hours)	Pack Qty	Note	Product Code	Fig. No.
G38 base (mogul prefocus)															
2500	240	-	CP94	67500	3200	BP	24x18	210	40	127	400	12	-	30500	3
3000	230	-	HX48	82000	3200	MP	24x26	210	47	127	400	12	K	30503	4
3000	240	-	HX48	82000	3200	MP	24x26	210	47	127	400	12	K	30504	4
5000	120	DPY	CP29	143000	3200	MP	31x36	280	65	165	500	6	-	41736	1

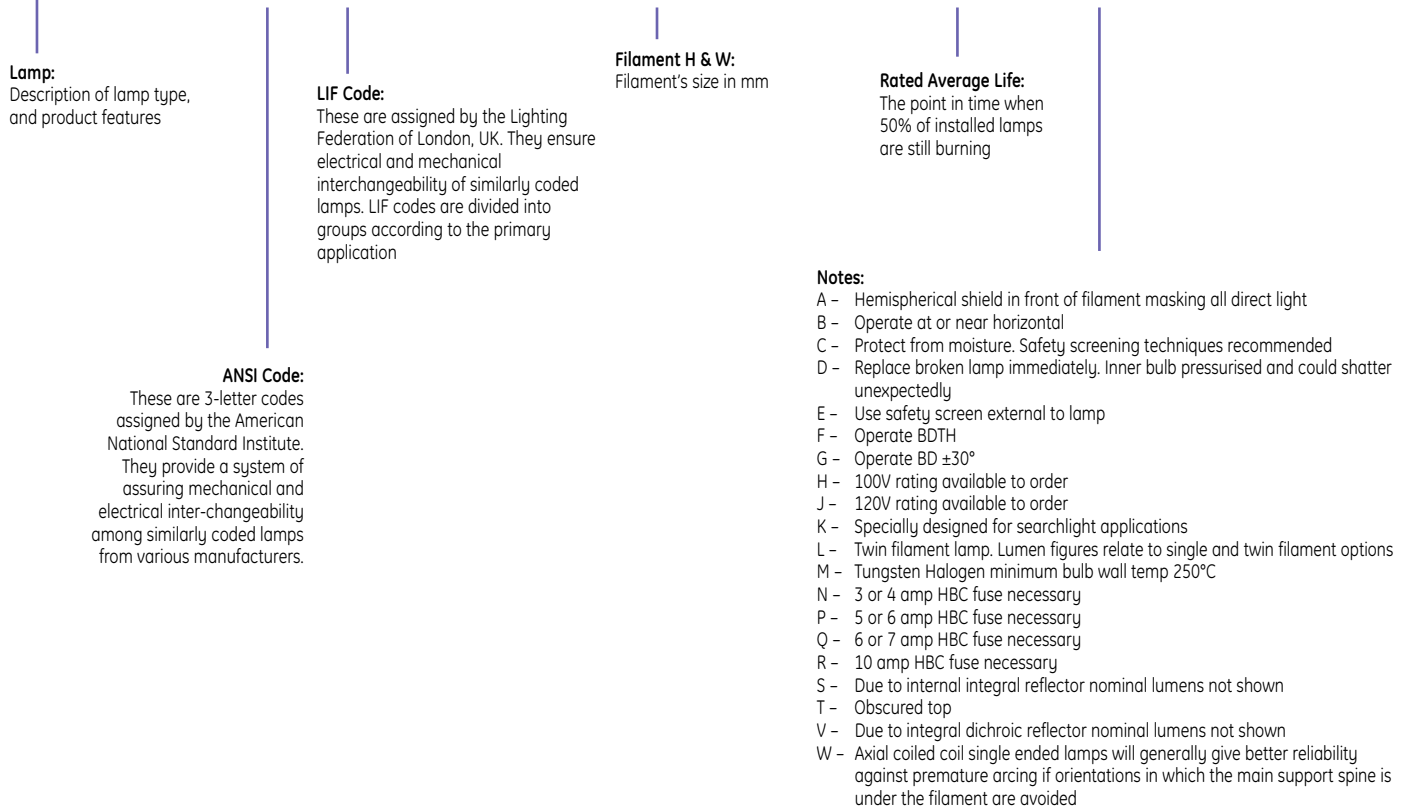

## PAR Lamps

PAR lamps provide a robust and flexible design solution for a wide range of theatre, studio and nightclub applications.

Choice of PAR 56 or PAR 64

- 3000K or 4200K colour temperature
- Choice of 3 beam widths
- Excellent colour rendering
- High efficiency combined with low operating costs
- Robust and reliable
- 8000 hours life
- UV control
- Easy retrofit
- Colour consistent throughout life
- Colour blends with halogen and fluorescent



PAR 36



PAR 56



PAR 64



Twister, Wilhelmshafen, Germany By Fischer Art of Light & Sound GmbH, Bremen

PAR Lamps

Watts	Volts	Order Code	Life (h)	Candela	Beam 10%	Beam 50%	CCT (K)	Pack Qty	Note	Product Code
PAR 36 Ferrule cap										
650	120	FCX	100	24000	-	40x30	3200	12	BC	41673
PAR 36 Screw Terminal cap										
25	5.5	25PAR36	1000	30000	5.5x4.5	-	3000	12	A	14553
25	12	25PAR36/NSP	2000	4500	19x17	10x8	-	12	A	14554
25	12	25PAR36/WFL	2000	500	49x41	37x26	-	12	A	14555
25	12	25PAR36/VWFL	2000	250	82x80	40x33	-	12	A	14556
30	12.8	4405	100	50000	6x5	-	-	12	AD	24425
30	6.2	4511	300	2300	TRAPEZOID	-	-	12	-	24663
30	6.4	H4515	100	67000	5.5x4	-	-	12	AD	15133
30	6.4	4515	100	55000	5x5	-	-	12	A	24673
50	12.8	H7604	100	100000	7x5	-	-	12	-	43576
50	12	50PAR36/VNSP	2000	25000	11x9	-	-	12	A	12892
50	12	50PAR36/NSP	2000	9200	20x17	11x9	-	12	A	16540
50	12	50PAR36/WFL	2000	1300	48x41	36x28	-	12	A	16541
50	12	50PAR36/WFL/H	4000	-	-	-	3050	12	-	19880
50	12	50PAR36/VWFL	2000	600	80x80	40x37	-	12	A	16542
50	28	4502	400	10000	40x7	-	-	12	-	24627
50	28	4505	400	45000	11x5	-	-	12	-	24640
100	13	4509	25	110000	12x6	-	-	12	-	24650
100	13	4509X	25	110000	12x6	-	-	12	-	41503
100	28	4595	300	60000	14x16	-	-	12	-	24892
100	28	4591	25	90000	12x6	-	-	12	-	24882
50	28	4593	400	1500	80x30	-	-	12	-	24887
100	28	4594	300	70000	13x7	-	-	12	BC	24891
150	28	4626	300	25000	40x9	-	-	12	-	24964
100	28	4627	300	3000	80x30	-	-	12	-	24966
250	28	4587	25	4000	40x13	-	-	12	-	24867
250	28	4596	25	150000	11x12	-	3000	12	-	24898
650	120	DWE	100	24000	-	40x30	3200	12	BC	41667
650	120	FBO	30	75000	-	25x15	3400	12	BC	41671
PAR 46 Screw Terminal cap										
30	12.8	4435	300	75000	5x5	-	-	12	A	24577
40	12.5	4531	400	30000	20x5	-	-	12	-	24726
50	12.8	H7635	100	160000	6.5x4	-	-	12	D	43591
100	13	4537-2	25	200000	11x16	-	-	12	-	40822
100	13	4537	25	200000	11x6	-	-	12	-	24742
150	28	4570	300	32000	50x9	-	-	12	-	24828
150	28	4571	300	7000	80x25	-	-	12	-	24830
250	28	4551	25	75000	50x10	-	-	12	-	24795
250	28	4553	25	300000	11x12	-	-	12	E	24799
450	28	4580	10	400000	13x14	-	-	12	-	24859
450	28	4581	10	400000	13x14	-	-	12	-	24862
450	16.5	4635	25	325000	14x15	-	-	12	-	33284
450	28	Q4554	25	65000	50x11	-	-	12	-	37706
450	28	Q4597	1000	16000	60x35	-	-	12	-	37372
450	28	Q4681	50	310000	15x9	-	-	12	-	36271
PAR 56 Screw Terminal cap										
100	12	4545	100	225000	9x5	-	-	12	A	24768
120	12	120PAR56/VNSP	2000	60000	15x10	8x6	-	12	-	19023
120	12	120PAR56/MFL	2000	19000	29x15	18x9	-	12	-	19024
120	12	120PAR56/WFL	2000	5625	50x25	35x18	-	12	-	19025
200	30	200PAR	500	270000	9x9	-	-	12	-	20122
240	12	240PAR56/VNSP	2000	140000	7x10	9x6	-	12	C	20575
240	12	240PAR56/WFL	2000	13000	50x27	35x18	-	12	C	20577
300	12	300PAR56/WFL	1000	-	-	-	-	12	-	23427
PAR 56 GX16d cap										
300	120	300PAR56/NSP	2000	68000	20x14	10x8	2750	12	C	20803
300	120	300PAR56/MFL	2000	24000	34x19	23x11	2750	12	C	20836
300	120	300PAR56/WFL	2000	11000	57x27	37x18	2750	12	C	20849
300	230	300PAR56/NSP	2000	40000	-	-	-	12	C	20853
300	230	300PAR56/MFL	2000	30000	-	-	-	12	C	20852
300	230	300PAR56/WFL	2000	10000	-	-	-	12	C	20854
300	240	300PAR56/NSP	2000	40000	-	-	-	12	C	18676
300	240	300PAR56/MFL	2000	30000	-	-	-	12	C	18677
300	240	300PAR56/WFL	2000	10000	-	-	-	12	C	18678
500	120	Q500PAR56/NSP	4000	96000	32x15	13x8	2950	6	CD	43494
500	120	Q500PAR56/MFL	4000	43000	42x20	26x10	2950	6	CD	43495
500	120	Q500PAR56/WFL	4000	19000	66x34	44x20	2950	6	CD	43496
PAR 64 Screw Terminal cap										
250	28	4552	25	500000	8x7	-	-	12	-	40576
600	28	4559	25	600000	11x12	-	-	12	C	40578
600	28	Q4559	100	600000	12x8	-	-	12	CD	40579
600	28	Q4559X	100	765000	11x7.5	-	-	12	CD	42552

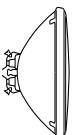
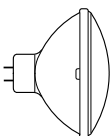
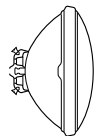
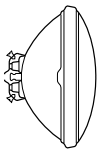
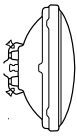
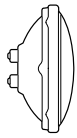

PAR Lamps

Watt	Volt	LIF Code	Order Code	Life (hours)	Candela	Beam 10%	Beam 50%	CCT K	Pack Qty	Note	Product Code
PAR 64 GX16d base (EMEP)											
500	230	CP86	Q500PAR64/VNSP	300	240000	16x13	10x7	3200	6	CD	25492
500	240	CP86	Q500PAR64/VNSP	300	240000	16x13	10x7	3200	6	CD	25493
500	230	CP87	Q500PAR64/NSP	300	140000	19x16	11x9	3200	6	CD	25504
500	240	CP87	Q500PAR64/NSP	300	140000	19x16	11x9	3200	6	CD	25507
500	230	CP88	Q500PAR64/MFL	300	65000	32x19	21x10	3200	6	CD	25513
500	240	CP88	Q500PAR64/MFL	300	65000	32x19	21x10	3200	6	CD	25520
500	230	-	500/PAR64/MFL	2000	-	32x19	21x10	2700	12	CD	39411
500	230	-	500/PAR64/W FL	2000	-	-	-	2700	12	CD	39414
1000	230	CP60	EXC SUPER	300	352000	12x9	20x17	3200	6	CD	88425
1000	240	CP60	EXC SUPER	300	352000	12x9	20x17	3200	6	CD	88551
1000	230	CP61	EXD SUPER	300	297000	14x10	22x20	3200	6	CD	88535
1000	240	CP61	EXD SUPER	300	297000	14x10	22x20	3200	6	CD	88550
1000	230	CP62	EXE SUPER	300	138000	24x11	38x20	3200	6	CD	88549
1000	240	CP62	EXE SUPER	300	138000	24x11	38x20	3200	6	CD	88536
1000	230	CP95	-	300	15000	125x95	70x70	3200	6	CD	88511
1000	240	CP95	-	300	15000	125x95	70x70	3200	6	CD	88510
1000	230	-	EXG/PAR64/WFL	300	38000	73x36	57x21	3200	6	CD	88480
1000	240	-	EXG/PAR64/WFL	300	38000	73x36	57x21	3200	6	CD	88479
500	120	-	500PAR64/NSP	2000	110000	19x14	12x7	2800	12	CD	39406
500	120	-	500PAR64/MFL	2000	37000	35x19	23x11	2800	12	CD	39409
1000	120	-	FFN	800	400000	24x10	12x6	3200	6	CD	13233
1000	120	-	FFP	800	330000	26x14	14x7	3200	6	CD	13229
1000	120	-	FFR	800	125000	44x11	28x12	3200	6	CD	13228
1000	120	-	FFS	800	40000	71x45	48x24	3200	6	CD	13227
1000	120	-	Q1000PAR64/NSP	4000	200000	31x14	15x8	3000	6	CD	43497
1000	120	-	Q1000PAR64/MFL	4000	80000	45x22	28x12	3000	6	CD	43498
1000	120	-	Q1000PAR64/WFL	4000	33000	72x45	48x24	3000	6	CD	43499

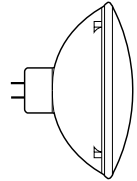

## Single Ended Halogen Lamps

An extensive range of lamps designed to optimal performance in today's precision range of stage, studio and architectural luminaires.

- Superior field smoothness and cosign distribution created by the HPL optical system
- Improved durability with integral heat sink base, reducing seal temperature and maximizing life
- Shock resistant filament array and patented gas chemistry minimizes arc-out risk during alignment and focusing
- Each wattage/voltage range has long life versions (LL), ideal for extended use applications
- Available in 4 wattage ranges and 5 voltage ranges for global usage



HPL



OC 1200



12K GX38



SINGLE ENDED HALOGEN LAMPS

Watt	Volt	Order Code	Lumen	CCT K	Filament	Fila. H x W	Dimension A	Dim. B	Dim. C	Life (hours)	Pack Qty	Product Code	Fig. No.
High Performance Lamps													
575	230	HPL 575	14900	3200	SCH	10 x 9.5	106	18	60.3	300	12	88478	1
575	240	HPL 575	14900	3200	SCH	10 x 9.5	106	18	60.3	300	12	88477	1
575	120	HPL 575-C	16520	3250	SCS	9 x 6	106	18	60.3	300	12	88436	2
575	115	HPL 575-C	16520	3250	SCS	9 x 6	106	18	60.3	300	12	88438	2
575	230	HPL 575-X LL	11780	3050	SCH	12 x 9.5	106	18	60.3	1500	12	88476	1
575	240	HPL 575-X LL	11780	3050	SCH	12 x 9.5	106	18	60.3	1500	12	88475	1
575	120	HPL 575-C LL-X	12360	3050	SCS	11 x 6	106	18	60.3	2000	12	88434	2
575	115	HPL 575-C LL-X	12360	3050	SCS	11 x 6	106	18	60.3	2000	12	88435	2
750	230	HPL 750	19750	3200	SCH	11.5 x 9.5	106	18	60.3	300	12	88474	1
750	240	HPL 750	19750	3200	SCH	11.5 x 9.5	106	18	60.3	300	12	88473	1
750	115	HPL 750-C	22000	3250	SCS	10.5 x 6.3	106	18	60.3	300	12	88437	2
750	115	HPL 750-C-XLL	16400	3050	SCS	13 x 6.3	106	18	60.3	2000	12	88428	2
750	230	HPL 750-X-LL	15600	3050	SCH	13 x 8	106	18	60.3	1500	12	88430	1
750	240	HPL 750-X-LL	15600	3050	SCH	13 x 8	106	18	60.3	1500	12	88429	1

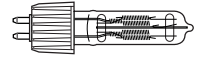

Fig. 1

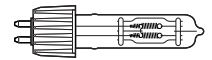

Fig. 2

Watt	Volt	ANSI Code	Order Code	Lumen	CCT K	Filament	Fila. H x W	Dimension A	Dim. B	Dim. C	Life (hours)	Pack Qty	Note	Product Code	Fig. No.
G9.5 base															
500	120	EHD	-	10000	2900	CC-8	18x5	105	20	60.5	2000	24	W	88624	3
575	115	FLK	HX600	16500	3200	CC-8	12.7x6	105	18	60.5	300	24	W	88548	3
575	115	FLK/LL	HX601	12800	3100	CC-8	13.7x6	105	18	60.5	1500	50	W	88452	3
600	230	GKV	HX600	14000	3200	C13-D	13.5x7.5	105	18	60.5	250	24	-	88448	4
600	240	GKV	HX600	14000	3200	C13-D	13.5x7.5	105	18	60.5	250	24	-	88447	4
600	230	GKV/LL	-	11000	3000	C13-D	16x8	105	18	60.5	1500	24	-	88446	4
600	240	GKV/LL	-	11000	3000	C13-D	16x8	105	18	60.5	1500	24	-	88445	4
650	240	FKR	-	15000	3100	CC-8	24x5	105	20	60.5	300	24	W	88450	3
750	120	EHF	-	20000	3200	CC-8	19x7	105	20	60.5	300	24	W	88627	3
750	120	EHG	-	15000	3000	CC-8	19x7	105	20	60.5	2000	24	W	88626	3
800	240	-	HX800	20000	3200	C13-D	15.8x8.4	105	18	60.5	250	24	-	88432	4
1000	120	FEL	CP77	27500	3200	CC-8	19x7	105	20	60.5	300	24	W	88625	3
1000	240	FEP	CP77	25000	3200	CC-8	24x7	105	20	60.5	300	24	W	88449	3

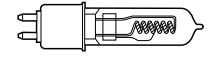

Fig. 3

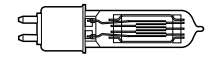

Fig. 4

Watt	Volt	LIF Code	Order Code	Lumen	CCT K	Filament	Fila. H x W	Dimension A	Dim. B	Dim. C	Life (hours)	Pack Qty	Note	Product Code	Fig. No.
GY9.5 base - Grid-form Filament															
300	120	CP81	FKW	6900	3200	S	15x10	90	25	46	50	24	-	88443	5
300	230	CP81	FSL	6900	3200	S	11x10	90	25	46	150	24	-	88433	5
300	240	CP81	FSK	6900	3200	S	11x10	90	25	46	150	24	-	88444	5
500	120	CP82	FRG	13000	3200	MP	12.5x11.5	90	25	46	150	24	-	88467	5
500	230	CP82	FRH	12500	3200	MP	13x13	90	25	46	150	24	-	88466	5
500	240	CP82	FRJ	12500	3200	MP	13x13	90	25	46	150	24	-	88464	5
500	240	T18	GCW	11000	3050	MP	13.5x13	90	23	46	400	24	-	88465	5
500	240	T25	GCW	11000	3000	BP	11x11	90	23	46.5	360	24	-	88470	5
650	240	T27	GCS	14500	3050	BP	13x11	90	23	46.5	400	24	-	88469	5
650	240	T26	GCS	15500	3100	MP	15.5x13.5	90	23	46	400	24	-	88463	5
650	120	CP89	FRK	16900	3200	MP	12.5x11.5	90	25	46	200	24	-	88462	5
650	240	CP89	FRM	16250	3200	MP	13x13	90	25	46	150	24	-	88461	5

S = Staggered Filament. Burning position VBD ±90

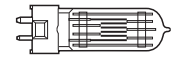

Fig. 5

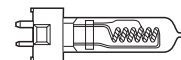

Fig. 6

GY9.5 base - Coiled Coil Filament															
600	120		FMR	12600	3050	CC-8	16x6	85	16	51	2000	24	W	88504	6

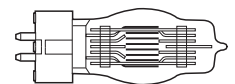

Fig. 7

GX9.5 base															
650	240	T12	-	13500	3000	MP	15.5x14.5	110	25	55	750	12	-	88431	8
650	230	CP23	-	16900	3200	MP	12x14.5	110	25	55	100	12	-	72680	8
650	240	CP23	-	16900	3200	MP	12x14.5	110	25	55	100	12	-	88455	8
1000	240	CP24	-	26000	3200	MP	18.5x17.5	110	35	55	200	12	-	88459	7
1000	115/120	T11	Q1000T8/CL	23500	3050	MP	16x14	110	35	55	750	24	-	88515	7
1000	240	T11	-	23000	3050	MP	17.5x17.5	110	35	55	750	12	-	88456	7
1000	240	T19	FWR	21000	3050	BP	15x12	110	35	55	750	12	HJ	88457	8
1000	230	CP70	FVA	25000	3200	BP	15x12	110	35	55	200	12	HJ	88472	8
1000	240	CP70	FVA	25000	3200	BP	15x12	110	35	55	200	12	HJ	88471	8
1200	240	T29	FWT	29000	3050	BP	16x13	125	35	67	400	12	-	88454	9
1200	240	CP90	-	33000	3200	BP	16x12	125	35	67	200	12	-	88453	9

Burning position VBD ±90

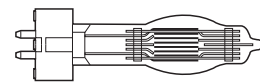

Fig. 8

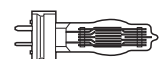

Fig. 9

GY16 base															
2000	240	CP43	FTL	54000	3200	MP	22x22.5	145	40	70	400	12	-	88533	10
2000	240	CP79	-	54000	3200	BP	18.5x17	145	40	70	350	12	-	88503	10

Burning position VBD ±90

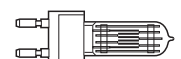

Fig. 10

G22 Low Voltage															
1200	80		OC1200	37500	3300	BP	10.5x12.5	140	26	63.5	300	12	-	88439	11

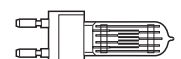

Fig. 11

SINGLE ENDED HALOGEN LAMPS

Watt	Volt	Ansi Code	LIF Code	Lumen	CCT K	Filament	Fila. H x W	Dimension A	Dim. B	Dim. C	Life (hours)	Pack Qty	Note	Product Code	Fig. No.
G22 base															
500	120	EGN	-	13000	3200	MP	12x11.5	140	21	63.5	150	12	-	88509	1
650	240	FKH	CP39	16900	3200	MP	12x14.5	140	25	63.5	100	12	-	88531	1
1000	120	EGT	-	28500	3200	MP	14.5x14	140	22	63.5	250	12	-	88622	1
1000	230	FKJ	CP40	26000	3200	MP	18.5x17.5	140	26	63.5	200	12	-	88458	1
1000	240	FKJ	CP40	26000	3200	MP	18.5x17.5	140	26	63.5	200	12	-	88538	1
1200	240	-	CP93	33000	3200	BP	16x12	140	35	63.5	200	12	-	88508	2
2000	120	-	CP92	55000	3200	BP	18x17	175	40	90	400	12	-	88507	3
2000	240	-	CP92	52000	3200	BP	18.5x17	175	40	90	400	12	-	88506	3
2500	240	-	CP91	67500	3200	BP	24x18	175	40	90	400	12	-	88505	3

Burning position VBD ±90

P28s base (medium prefocus)

500	120	EGE	-	10450	2950	CC-8	18x5	152	13	88.9	2000	12	-	88617	5
500	120	BTM	-	13000	3200	MP	12x11.5	130	21	55.5	150	12	-	88546	6
500	240	FKF	T17	9500	2950	MP	13.5x14.5	130	21	55.5	750	12	-	88498	6
500	240	-	T28	11000	3000	MP	15x12	130	21	55.5	300	12	-	88451	6
650	240	-	T13	13500	3000	MP	15.5x14.5	130	25	55.5	750	12	-	88497	6
650	240	-	CP51	16900	3200	MP	12x14.5	130	25	55.5	200	12	-	88530	6
1000	120	EGJ	-	27500	3200	CC-8	19x7	152	20	88.9	500	12	W	88615	5
1000	240	-	T14	23000	3050	MP	17.5x17.5	130	35	55.5	750	12	-	88529	7
1000	240	FKE	T15	23000	3050	MP	17.5x17.5	160	35	88.9	750	12	-	88499	4
1000	240	FKN	CP52	26000	3200	MP	18.5x17.5	130	35	55.5	200	12	-	88496	7

Burning position VBU ±90

G38 base (mogul prefocus)

2000	120	CYX	HX270	59000	3200	MP	21.5x20.5	216	32	127	400	6	-	88610	10
2000	230	FKK	CP41	54000	3200	MP	22x22.5	216	32	127	400	12	-	88489	10
2000	240	FKK	CP41	54000	3200	MP	22x22.5	216	32	127	400	12	-	88488	10
2500	240	-	CP94	67500	3200	BP	24x18	210	40	127	400	12	-	88502	10
3000	240	-	HX48	82000	3200	MP	24x26	210	47	127	400	12	K	88874	11
5000	230	-	CP29	135000	3200	MP	36x33	280	65	165	500	12	-	88875	8
5000	240	-	CP29	135000	3200	MP	36x33	280	65	165	500	12	-	88876	8
10000	220/230	-	CP83	280000	3200	MP	38x56	405	85	254	250	1	-	12036	9
10000	240	-	CP83	280000	3200	MP	39x56	405	85	254	250	1	-	12037	9

Burning position VBD ±90 except HX48 VBD ±45

Watt	Volt	Order code	Lumen	CCT K	Filament	Fila. H x W	Dimension A	Dim. B	Dim. C	Life (hours)	Pack Qty	Note	Product Code	Fig. No.	
GX38 base – Single-ended High Wattage Halogen Lamps															
12000	230	Q12MT26/4CL	420000	3400	MP	37x56	410	254	85	130	1	-	48771	12	
12000	240	Q12MT26/4CL	420000	3400	MP	36x56	410	254	85	130	1	-	48779	12	
20000	230	BCM-020MT324CL	580000	3200	MP	50x92	560	354	103	400	1	-	48773	13	
20000	240	BCM-020MT324CL	580000	3200	MP	52x92	560	354	103	400	1	-	48774	13	
24000	230	Q24MT32/4CL	800000	3400	MP	46x92	560	354	103	150	1	-	48776	13	
24000	240	Q24MT32/4CL	800000	3400	MP	52x92	560	354	103	150	1	-	48777	13	

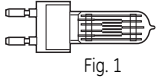

Fig. 1

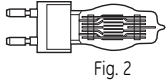

Fig. 2

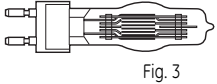

Fig. 3

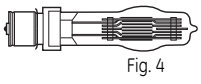

Fig. 4

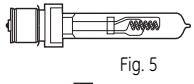

Fig. 5

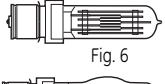

Fig. 6

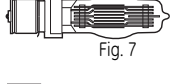

Fig. 7

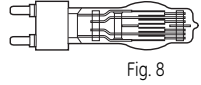

Fig. 8

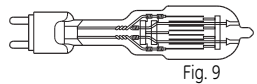

Fig. 9

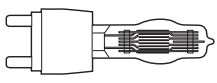

Fig. 10

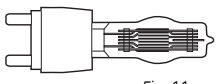

Fig. 11

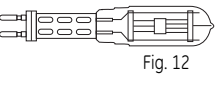

Fig. 12

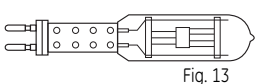

Fig. 13

SINGLE ENDED HALOGEN LAMPS

Watt	Volt	Ansi Code	LIF Code	Lumen	CCT K	Filament	Fila. H x W	Dimension A	Dim. B	Dim. C	Life (hours)	Pack Qty	Note	Product Code	Fig. No.
GX38q base - Twin filament															
1250/650	240	-	CP105	27000/13000	3050	TF	24x18.5	220	55	143	250	12	L	88880	1
1250/1250	240	-	CP30	27000/56000	3200	TF	24x18.5(x2)	220	55	143	250	12	L	88877	1
1250/2500	240	-	CP58	27000/59000/91000	3200	TF	27.5x25/24x22)	220	70	143	300	12	L	88878	1
2500/2500	240	-	CP32	5900/127000	3200	TF	27.5x25(x2)	220	70	143	300	12	L	88879	1

Burning position VBD ±45

Watt	Volt	Ansi Code	LIF Code	Lumen	CCT K	Filament	Fila. H x W	Dimension A	Dim. B	Dim. C	Life (hours)	Pack Qty	Note	Product Code	Fig. No.
E40 base - Clear, Coil Filament															
2000	240	-	CP59	50000	3200	CC-8	40x7	190	30	133	300	12	W	88512	2
E40 base - Frosted, Coil Filament															
1000	120	DKZ/DSE	-	28000	3200	CC-8	-	330	165	-	750	10	-	19926	3

DKX/DSF Burning position - any

P40s base (mogul prefocus)															
Watt	Volt	Ansi Code	LIF Code	Lumen	CCT K	Filament	Fila. H x W	Dimension A	Dim. B	Dim. C	Life (hours)	Pack Qty	Note	Product Code	Fig. No.
1000	240	-	T16	23000	3050	MP	17.5x17.5	180	35	87	750	12	-	88501	4
1500	120	DTA	T16	41000	3200	MP	19x17	200	40	87	300	6	-	88500	5
2000	240	-	CP53	54000	3200	MP	22x22.5	200	40	87	400	12	-	88532	5

Burning position VBD ±90

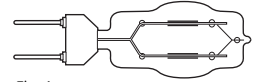

Fig. 1

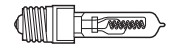

Fig. 2



Fig. 3

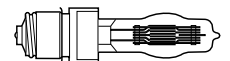

Fig. 4

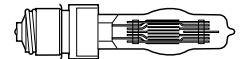
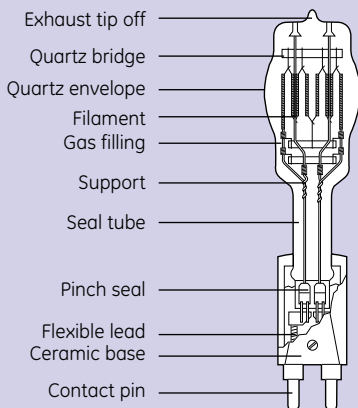
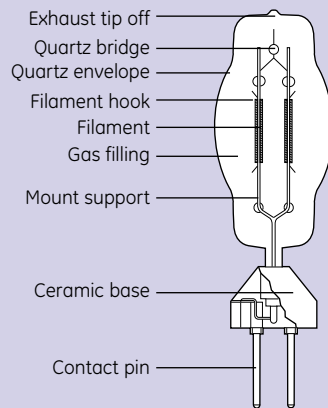

Fig. 5

A typical high wattage studio lamp



A typical 4 pin twin filament studio lamp



A typical low wattage theatre class tungsten halogen lamp

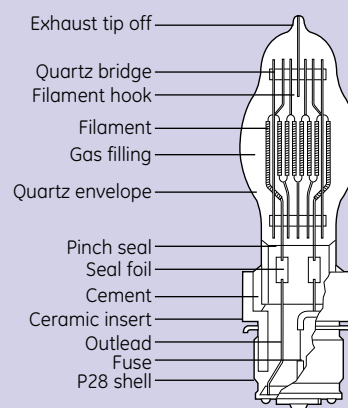

## Linear Halogen Lamps

This precision range of quartzline lamps are widely used in television broadcast studios around the world.

- Available from 650-2000W
- 3200K



P2/27



CNBC Europe's Studio. CNBC, the 24-hour global business television news channel



## Linear Halogen Lamps

Watt	Volt	LIF Code	Order Code	Lumen	CCT K	Filament	Dimension A	Dim. B	Life (hours)	Pack Qty	Note	Product Code	Fig. No.
Double-Ended Quartzline® Lamps with R7s Caps													
Length 79.4mm													
650	120	P2/6	FAD	16500	3200	CC-8	79.4	13.5	100	24	C	30325	1
800	230	P2/13	DXX	21400	3200	CC-8	79.4	13.5	75	24	C	36952	1
800	240	P2/13	DXX	21400	3200	CC-8	79.4	13.5	75	24	C	36953	1
Length 95.3mm													
1000	120	-	DXW	28000	3200	CC-8	95.3	16	150	24	-	30157	2
1000	120	-	FBY	26000	3200	CC-8	95.3	16	150	24	Frost	30374	2
Length 119.1mm - Burn Horizontal ±4°													
750	120	-	EJG	20600	3200	C-8	119.1	11	400	12	-	23756	3
800	240	P2/11	EME/Clear	22000	3200	C-8	119.1	11	150	12	-	23760	3
800	240	P2/11	EMF/Frosted	21400	3200	C-8	119.1	11	150	12	-	23761	3
1000	120	P2/28	FCM	28000	3200	C-8	119.1	11	400	12	-	23797	3
Length 142.9mm - Burn Horizontal ±4° - RX7s Caps													
2000	230	P2/27	FEX	50000	3200	CC-8	142.9	30	300	12	-	88482	4
2000	240	P2/27	FEX	50000	3200	CC-8	142.9	30	300	12	-	88481	4
2000	120	P2/27	FEY	57000	3200	CC-8	142.9	30	400	12	-	88629	4
Length 189.1mm - Burn Horizontal ±4°													
625	230	P2/10	-	16900	3200	C-8	189.1	12	300	12	-	19697	5
625	240	P2/10	-	16900	3200	C-8	189.1	12	300	12	-	19698	5
1000	230	P2/7	EKM	28000	3200	C-8	189.1	12	300	12	-	20249	5
1000	240	P2/7	EKM	28000	3200	C-8	189.1	12	300	12	-	20253	5
1250	230	P2/12	-	35000	3200	C-8	189.1	12	300	12	-	19695	5
1250	240	P2/12	-	35000	3200	C-8	189.1	12	300	12	-	19696	5

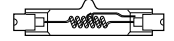

Fig. 1

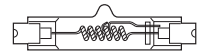

Fig. 2



Fig. 3

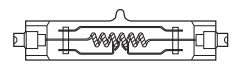
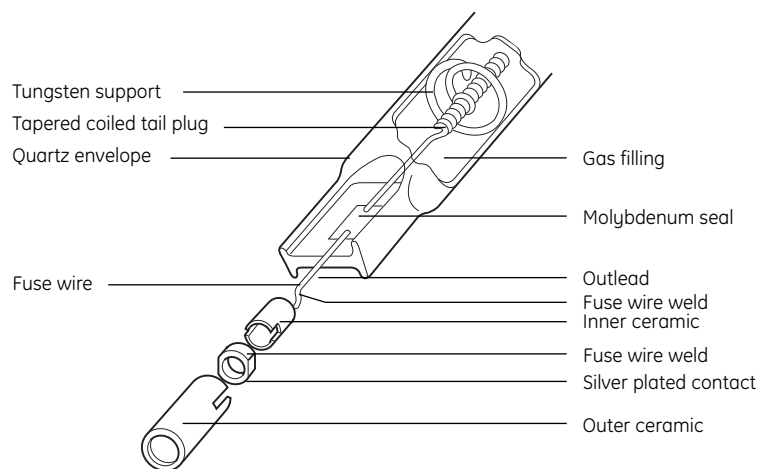

Fig. 4



Fig. 5

End section of a typical quartz linear tungsten halogen lamp



## Specialist Projector Lamps

A full range of specialist projection lamps are designed to deliver excellent optical performance and reliability.

**ELC Specialist Projector lamps' key features:**

- Precisely manufactured, tailored filaments which maximise source brightness giving optimum performance in disco applications
- High light-generating efficacy to help minimise power consumption and heat generation
- Prefocus-type caps or precision rim mounting to position the filament accurately in relation to the associated optics



Projector



Single Ended Capsules



ELC Specialist Projector



Overhead Projector, ACCO UK



Specialist Projector Lamps

Watt	Volt	ANSI Code	LIF Code	Lumen	Burning position	Filament	Fila. H x W"	CCT K	Dimension A	Dim. C	Life (hours)	Cap	Pack	Note	Product Code	Fig. No.
Single-ended Quartzline™- Projector Lamps																
30	6.6	EXL	-	375	-	C-8	3.3x1.3	2900	44.5	25	1000	GZ9.5	24	M	11478	-
30	10.8	DZA	-	800	BDTH	C-6	3.8x1.3	3100	51	27	400	G5.3	24	M	37346	2
50	12	BRL	A1/220	1400	BDTH	C-6	3.3x1.6	3400	44	30	50	G6.35	100	M	18234	1
100	12	FCR	A1/215	3500	BDTH	C-6	5.1x3.8	3300	44	30	50	GY6.35	100	M	14876	1
100	12	FDT	A1/261	2900	BDTH	C-6 Oval	5.8x3.8	3300	54	27	50	GZ9.5	24	M	35321	4
150	6.6	EWR	-	4100	-	C-6 Oval	6.4x4.1	3200	64	39	500	GZ9.5	24	M	11427	-
150	15	BRJ/EVB	A1/234	5000	BDTH	C-6 Oval	4.8x3.0	3400	44	30	50	G6.35	100	M	18235	1
150	24	DZE/FDS	A1/262	5000	BDTH	C-6 Oval	6.4x3.8	3250	68	33	100	GZ9.5	24	M	37695	4
150	24	FCS	A1/216	4500	BDTH	C-6 Oval	6.4x3.8	3300	51	30	50	G6.35	100	M	13598	1
250	24	EHJ	A1/223	9000	BDTH	C-6 Oval	7.6x3.8	3400	57	33	50	G6.35	100	M	14874	1
275	24	FNT	-	10000	BDTH	C-6 Oval	3.5x7.1	3400	57	33	50	G6.35	100	M	18241	1
400	36	EVD	A1/239	16000	BDTH	C-6 Oval	9.4x4.7	3200	60	36	50	GY6.35	25	M	41164	1
650	230	DYR	A1/233	16500	Any	2CC-8	11.4x11.4	3200	64	37	50	GZ9.5	24	CMN	26896	5
650	240	DYR	A1/233	16500	Any	2CC-8	11.4x11.4	3200	64	37	50	GZ9.5	24	CM	26895	5
800	240	-	HX185	19000	BDTH	-	-	3050	100	53	300	GX9.5	24	M	88484	3
1000	120	BRH	-	30000	-	CC-8	-	3350	-	-	60	R7S	24	-	29604	-

\* Ceramic

Watt	Volt	LIF Code	Lumen	Burning position	Filament	Dimension A	Dim. B	Dim. C	Life (hours)	Cap	Pack Qty	Note	Product Code	Fig. No.
A1 Class Projector Bulbs														
150	240	A1/248	3000	BDTH	MP	62	16.3	40	50	G6.35	50	MT	88492	6
300	240	A1/249	7200	BDTH	MP	62	16.3	40	50	G6.35	50	MNT	88491	6
500	240	A1/244	13000	BDTH	MP	75	28.5	36.5	75	GY9.5	24	MN	88460	7
800	240	A1/245	21500	BDTH	MP	87	28.5	44.5	75	GY9.5	24	MP	39649	7

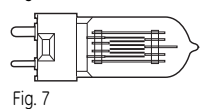
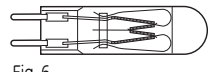
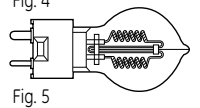
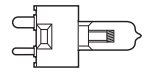
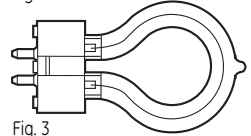
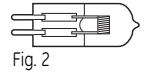
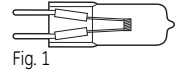

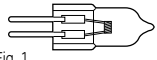

Fig. 1

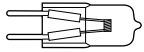

Fig. 2

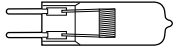

Fig. 3

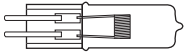

Fig. 4

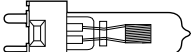

Fig. 5

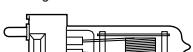

Fig. 6



Fig. 7

## Single-ended Tungsten Halogen Lamps

Watt	Volt	LIF Code	Lumen	CCT K	Filament	Dimension A	Dimension B	Dimension C	Life (hours)	Cap	Pack Qty	Product Code	Fig. No.
<b>Low Voltage single-ended capsule</b>													
10	6	M29/ESA	200	3200	Trans	30	10	19.5	100	G4	20	34720	1
20	6	M30/ESB	450	3200	Trans	30	10	19.5	100	G4	20	34718	1
50	12	M32	930	3000	Trans	44	12	30	4000	GY6.35	20	34702	2
100	12	M28/EVA	2400	3000	C-6 Oval	44	12	30	2000	GY6.35	20	34676	3
250	24	M33	8600	3000	C-6 Oval	55	13.5	33	300	G6.35	100	34768	3
250	24	M36	5750	3000	C-6 Oval	58	15	30	2000	G6.35	100	88516	4
<b>Mains Voltage single-ended capsule</b>													
300	240/250	M38	5000	2900	CC	80	28.5	45.5	2000	GY9.5	24	88442	5
500	240/250	M40	8500	2900	SC	85	30	45.5	2000	GY9.5	24	88468	6

## Double-ended lamps with R7s caps

Watt	Volt	ANSI Code	LIF Code	Application	CCT K	Filament	Dimension A	Dimension B	Life (hours)	Pack Qty	Note	Product Code	Fig. No.
<b>Linear Projector Lamps</b>													
420	120	FAL	A1/227	Overhead projector	3200	CC-8	66.5	13.5	75	24	M	29581	7

## Multi-Mirror® Quartzline® Projection lamps

Watt	Volt	ANSI Code	LIF Code	Application	CCT K	Filament	Dimension A	Dimension B	Working distance	Life (hours)	Cap	Pack Qty	Note	Product Code	Fig. no
<b>MR-16 Faceted Dichroic Reflector</b>															
30	10.8	EKZ	-	16mm projection	3100	C-6	44.45	50.67	40	200	GX5.3	20	MV	36902	1
50	8	EFM	A1/229	8mm projection	3300	C-6	44.45	50.67	32	50	GZ6.35	20	MV	21276	2
75	12	EFN	A1/230	8mm projection	3350	CC-6	44.45	50.67	32	50	GZ6.35	20	MV	21277	2
80	19	DDM	-	Slide projection	3350	CC-6	44.45	50.67	155	50	GX5.3	20	MV	43206	1
80	21	DDS	-	Microfilm	3125	CC-6	44.45	50.67	165	1000	GX5.3	20	MV	43988	1
85	13.8	DED	-	Microfilm	3150	CC-6	44.45	50.67	165	1000	GX5.3	20	MV	43950	1
100	12	EFP	A1/231	8mm projection	3350	CC-6	44.45	50.67	32	50	GZ6.35	20	MV	21278	2
150	15	EFR	A1/232	8mm projection	3350	CC-6	44.45	50.67	32	50	GZ6.35	20	MV	21279	2
150	20	DDL	-	Microfilm	3150	CC-6	44.45	50.67	200	500	GX5.3	20	MV	43537	1
150	21	ELD/EJN	-	Microfilm	3350	CC-6	44.45	50.67	165	40	GX5.3	20	MV	38306	1
150	21	EJM	-	8mm projection	3350	CC-6	44.45	50.67	40	40	GX5.3	10	MV	29151	1
150	21	EKE	-	8mm projection	3250	CC-6	44.45	50.67	45	200	GX5.3	20	MV	35200	1
200	24	EJL	A1/252	16mm, Colour printer	3400	CC-6	44.45	50.67	32	50	GX5.3	20	MV	29150	1
250	24	ELC	A1/259	16mm, Colour printer	3400	CC-6	44.45	50.67	30	50	GX5.3	20	MV	37462	1
250	24	ELC500	-	Disco	3250	CC-6	44.45	50.67	30	500	GY5.3	20	MV	15377	1
250	120	ENH	-	Slide projection	3250	CC-8	44.45	50.67	155	175	GY5.3	20	MV	38686	3
300	120	ELH	-	Slide projection	3350	CC-8	44.45	50.67	155	35	GY5.3	10	MV	38476	1
<b>MR-16 Dichroic Reflector</b>															
150	21	EJA	-	Fibre optics	3350	CC-6	44.45	50.67	28	40	GX5.3	20	MV	32882	2



Multi-Mirror® Quartzline® Projection lamps

Watt	Volt	ANSI Code	Application	CCT K	Filament	Dimension A	Dimension B	Working distance	Life (hours)	Cap Qty	Pack	Note	Product Code	Fig. no
MR-16 Faceted Dichroic Reflector														
25	13.8	FHX	Microfilm	3200	CC-6	44.45	50.67	110	250	GX5.3	20	MV	47914	1
42	10.8	EPT	Fibre optics	2900	C-6	44.45	50.67	40	8000	GX5.3	20	MV	41729	1
50	12	ENL	Fibre optics*	3050	C-6	44.45	50.67	40	4000	GX5.3	20	MV	25475	1
90	14.5	EPV	Microfilm	3150	CC-6	44.45	50.67	155	500	GX5.3	20	MV	41882	1
90	14.5	EPX	Microfilm	3150	CC-6	44.45	50.67	165	500	GX5.3	20	MV	42614	1
150	120	ESD	Enlarger, projection	3350	CC-8	44.45	50.67	45	12	GY5.3	20	MV	43756	2
150	120	EZK	Camera light	3200	CC-8	44.45	50.67	-	200	GY5.3	20	MV	15477	2
340	36	ERV	Overhead projection	3300	CC-8	44.45	50.67	300	75	GX5.3	20	MV	41874	2
360	82	ENX	Overhead projection	3300	CC-8	44.45	50.67	300	75	GY5.3	20	MV	41705	2
410	82	FXL	Overhead projection	3300	CC-8	44.45	50.67	300	38	GY5.3	20	MV	21613	2

\* Display lighting

MR-11 Faceted Dichroic Reflector														
28	13.8	FLT	Microfilm	3050	CC-6	40	35.3	76 or 175	500	GZ4	10	MV	25261	1

MR-13 Faceted Dichroic Reflector														
250	82	EXY	Slide projection	3200	CC-8	44.4	42.4	150	200	GX5.3	10	MV	12097	2
225	68	EZF/EZJ	Colour printer		CC-8	44.4	42.4	-	500	GX5.3	10	MV	15832	2
300	82	EXR	Slide projection	3350	CC-8	44.4	42.4	150	35	GX5.3	10	MV	12092	2
300	82	FHS	Slide projection	3300	CC-8	44.4	42.4	150	70	GX5.3	10	MV	47614	2

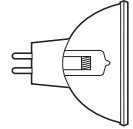

Fig. 1

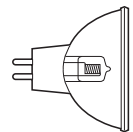

Fig. 2

## Discharge Lamps

New CSR & CSD lamps have been introduced to increase the range of discharge products for use in Stage & Studio applications.

GE UV Control lamps are the newest addition to the GE hot restrike line of entertainment metal halide lamps.

- 95% Reduction of UVB and UVC
- Greater than 85% reduction of total UV emissions
- 5600 Kelvin colour temperature
- No reduction in lumen output



CSD 250/2



CSR 575/2



Discharge Lamps

Watt	Volt	Description	Finish	CCT K	Lumen	Burning position	Life (hours)	Pack Qty	Cap	Product Code	Fig. No.
<b>Single Ended Hot Restrike</b>											
125	80	CSR125/SE/HR	CLEAR	5600	9400	UNIVERSAL	200	10	GZY9.5	48461	1
200	80	CSR200/SE/HR	CLEAR	5600	15000	UNIVERSAL	200	10	GZY9.5	48462	1
400	70	CSR400/SE/HR	CLEAR	5900	32000	UNIVERSAL	750	10	GZZ9.5	21853	1
400	70	CSR400/SE/HR/75	CLEAR	7500	32000	UNIVERSAL	750	10	GZZ9.6	45238	1
575	95	CSR575/SE/HR	CLEAR	6000	48000	UNIVERSAL	750	10	G22	48463	2
800	95	CSR800/SE/HR	CLEAR	6000	64000	UNIVERSAL	750	6	G22	22495	2
1200	100	CSR1200/SE/HR	CLEAR	6000	110000	UNIVERSAL	750	6	G38	48464	3
2500	115	CSR2500/SE/HR	CLEAR	6000	220000	UNIVERSAL	500	6	G38	48465	4
4000	200	CSR4000/SE/HR	CLEAR	6000	380000	UNIVERSAL	500	6	G38	48466	4
6000	123	CSR6000/SE/HR	CLEAR	6000	540000	UNIVERSAL	300	6	G38	48467	5
12000	160	CSR12000/SE/HR	CLEAR	6000	1100000	UNIVERSAL	250	4	G38	48468	5
18000	225	CSR18000/SE/HR	CLEAR	6000	1650000	UNIVERSAL	250	1	G51	22496	5
<b>Single Ended Cold Start</b>											
150	95	CSR 152/SE	CLEAR	5000	10000	UNIVERSAL	2000	10	GY9.5	22862	1
250	90	CSD250/2/SE	CLEAR	8500	18000	UNIVERSAL	2000	10	GY9.5	27817	1
575	95	CSR575/2/T/SE	CLEAR	7200	49000	UNIVERSAL	1000	10	GX9.5	49492	1
575	95	CSR575/2/SE	CLEAR	7200	49000	UNIVERSAL	1000	10	GX9.5	15378	2
700	72	CSR700/2/SE	CLEAR	7200	55000	UNIVERSAL	1000	10	G22	49491	2
1200	100	CSR1200/2/SE	CLEAR	7200	110000	UNIVERSAL	1000	6	G22/30x53	49490	2
<b>Double Ended Hot Restrike</b>											
200	80	CSR200/DE	CLEAR	6000	16000	HORIZONTAL±15°	300	10	X515	48450	1
400	49E	CSR400/S/DE/90	CLEAR	9000	26000	ANY	750	10	SFc 10-4 SI/M4	45232	1
400	49E	CSR400/S/DE/75	CLEAR	7500	26000	ANY	750	10	SFc 10-4 SI/M4	22478	1
575	95	CSR575/DE	CLEAR	6000	49000	HORIZONTAL±15°	750	10	SFc 10-4 SI/M4	70979	2
575	95	CSR575/SS/DE/75	CLEAR	7000	44000	HORIZONTAL±15°	750	10	SFc 10-4 SI/M4	45231	1
700	70E/73M	CSR700/S/DE/60	CLEAR	7500	59000	ANY	750	10	SFc 10-4 SI/M4	22493	2
700	70E/73M	CSR700/S/DE/72	CLEAR	7200	59000	ANY	750	10	SFc 10-4 SI/M4	41357	1
1200	95E/100M	CSR1200S/DE/60	CLEAR	6000	110000	ANY	750	10	SFc 10-4 SI/M4	22494	2
1200	95E/100M	CSR1200S/DE/72	CLEAR	7200	110000	ANY	750	10	SFc 10-4 SI/M4	41361	1
1200	100	CSR1200/DE	CLEAR	6000	110000	HORIZONTAL±15°	750	10	SFc 10-5-6	48453	2
2500	115	CSR2500/DE	CLEAR	6000	240000	HORIZONTAL±15°	500	6	Sleeve/Thd.Pin M6 Sta 21-12	48454	3
4000	200	CSR4000/DE	CLEAR	6000	410000	HORIZONTAL±15°	500	6	Sta 21-12	48455	3
6000	125	CSR6000/DE	CLEAR	6000	570000	HORIZONTAL±15°	300	10	25x51 cylinder LEAD 165mm	48456	3
12000	160	CSR12000/DE	CLEAR	6000	1100000	HORIZONTAL±15°	300	10	30x70 cylinder LEAD 165mm	48457	4
18000	225	CSR18000/DE	CLEAR	6000	1650000	HORIZONTAL±15°	300	6	30x70 cylinder LEAD 165mm	48459	4
<b>Short Arc</b>											
700	70	CSR700SA	CLEAR	5600	58000	UNIVERSAL	750	10	GY9.5	15380	1
700	70	CSR700SA/72	CLEAR	7200	58000	UNIVERSAL	750	10	GY9.5	45234	1
1200	100	CSR1200SA	CLEAR	6000	96000	UNIVERSAL	750	6	GY22	21849	1
1800	TBA	CSR2000SA	CLEAR	5600	155000	UNIVERSAL	750	6	GY22	21801	1

Discharge lamps must be operated in an enclosed fixture.  
Discharge lamps require control gear.

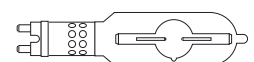
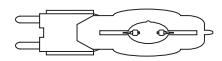
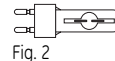
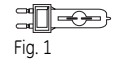

Fig. 5

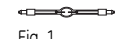

Fig. 1



Fig. 2



Fig. 3

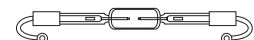
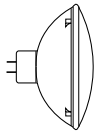

Fig. 4



Fig. 1

**Ceramic Metal Halide (CMH)**



Watt	Volt	Description	Lens Style	CCT K	CRI	Beam	Beam 10%	Beam 50%	MPBC	Life (hours)	Pack Qty	Cap	Product Code
CMH PAR64 – Architainment													
150	95	CMH150/PAR64/830/GX16d/SP 1/6	Stipple	3000	80+	Narrow	9x9	4x4	240000	8000	6	GX16d	88545
150	95	CMH150/PAR64/830/GX16d/MFL 1/6	8-Bar	3000	80+	Medium	18x15	13x11	80000	8000	6	GX16d	88537
150	95	CMH150/PAR64/830/GX16d/WFL 1/6	12-Bar	3000	80+	Wide	25x20	18x15	33000	8000	6	GX16d	88544
150	100	CMH150/PAR64/942/GX16d/SP	Stipple	4200	90+	Narrow	9x9	4x4	240000	8000	6	GX16d	88543
150	100	CMH150/PAR64/942/GX16d/MFL	8-Bar	4200	90+	Medium	18x15	13x11	80000	8000	6	GX16d	88542
150	100	CMH150/PAR64/942/GX16d/WFL	12-Bar	4200	90+	Wide	25x20	18x15	33000	8000	6	GX16d	88541

Discharge lamps must be operated in an enclosed fixture.  
Discharge lamps require control gear.

**CMH PAR 56 Architainment**

150	95	CMH150/PAR56/830/GX16d/SP	Stipple	3000	80+	Narrow	68X63	14X19	80000	5000	6	GX16d	88522*
150	95	CMH150/PAR56/830/GX16d/MFL	8-Bar	3000	80+	Medium	74X65	19X22	60000	5000	6	GX16d	88521*
150	95	CMH150/PAR56/830/GX16d/WFL	12-Bar	3000	80+	Wide	81X67	29X23	50000	5000	6	GX16d	88520*
150	100	CMH150/PAR56/942/GX16d/SP	Stipple	4200	90+	Narrow	68X63	14X19	80000	5000	6	GX16d	88519*
150	100	CMH150/PAR56/942/GX16d/MFL	8-Bar	4200	90+	Medium	74X65	19X22	60000	5000	6	GX16d	88518*
150	100	CMH150/PAR56/942/GX16d/WFL	12-Bar	4200	90+	Wide	81X67	29X23	50000	5000	6	GX16d	88517*

**CSR UV Control Lamps**

Watt	Cap	CCT K	Lumens	Order Description	Avg. Rated Life	Pack Qty	Product Code
575	G22	5600	49000	CSR575/SE/HR/UV-C	750	10	40460
800	G22	5600	64000	CSR800/SE/HR/UV-C	1000	10	22495
1200	G22	5600	110000	CSR1200/SE/HR/UV-C	750	6	27764
2500	G22	5600	220000	CSR2500/SE/HR/UV-C	500	6	40482
4000	G22	5600	380000	CSR4000/SE/HR/UV-C	500	6	27765
6000	G22	5600	540000	CSR6000/SE/HR/UV-C	300	6	40492

**CSS**

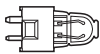

Fig. 1

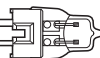

Fig. 2

Watt	Volt	Order Code	Lumen	CCT K	CRI	Dimension A	Dim. B	Dim. C	Life (hours)	Pack Qty	Product Code	Fig. No.
Base: GY9.5 - Burning position: VBD±90												
140	85	CSS150/850/GY9.5	10000	5000	80	48	22	30	1000	10	88485	1

**CSI/CID Lamps**

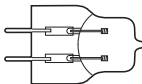

Fig. 3

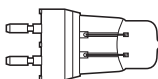

Fig. 4

Watt	Volt	Order Code	Lumens 100 hrs	Lumen maintenance	CCT K	CRI	Life (hours)	Pack Qty	Product Code	Fig. No.
(Compact Source Iodide/Compact Iodide Daylight) Special bipin base (2 pin 9mm) - Burning position: VBD±90										
400	100	99-0201 CSI	32000	85% at 500 hrs	4000±400	80	500	1	88495	3
G22 base (medium bipost) Burning position: VBD±90										
1000	77	99-0221 CSI	90000	85% at 500 hrs	4000±400	80	500	1	88494	4

Discharge lamps must be operated in an enclosed fixture.  
Discharge lamps require control gear.



Watt	Volt	Order Code	Axial intensity Cd	Angle 1/2	Angle 1/10	CCT K	CRI	Life (hours)	Pack Qty	Product Code	Fig. No.
G38 base (mogul bipost) Burning position: HOR±90											
1000	77	99-1222 CSI CS	1350000	6	18	3800±500	80	3500	1	88514	4
1000	77	99-1422 CSI HR	1350000	6	18	3800±500	80	3500	1	88513	4

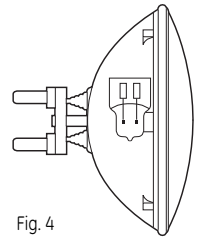

Fig. 4

Watt	Volt	Order Code	Lumens 100 hrs	Lumen maintenance	CCT K	CRI	Life (hours)	Pack Qty	Product Code	Fig. No.
G22 base (medium bipost) Burning position: VBD±90										
1000	77	99-0222 CID	70000	90% at 500 hrs	5500±400	85	500	1	88493	2

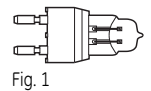

Fig. 1

### Cinema Lamps

Watt	Order Code	Description	Life (hours)	Pack Qty	Product Code	Fig.No.
Cinema High Lumen Biax™						
55	F55BX/CINEMA32	Indoor	10000	10	41869	1
55	F55BX/CINEMA56	Daylight	10000	10	41873	1
Cinema Plus Biax™						
55	F55BX/CINPLUS/32	Indoor	40	10	41903	1
55	F55BX/CINPLUS/55	Daylight	40	10	41911	1
T12						
35	F20T12/CINEMA32/HO/CVG	Indoor	7000	24	15775	2
35	F20T12/CINEMA55/HO/CVG	Daylight	7000	24	15776	2
75	F40T12/CINEMA32/HO/CVG	Indoor	12000	30	15782	2
75	F40T12/CINEMA55/HO/CVG	Daylight	12000	30	15783	2

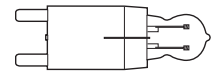
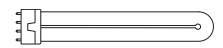
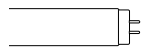
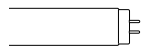

Fig. 3



Fluorescent Cinema Lamps – life on rapid start ballast  
CVG = These lamps feature GE's exclusive CovrGuard coating

Watt	Order Code	Description	Dimension A	Life (hours)	Pack Qty	Product Code	Fig.no
Blacklight Blue (produce long wave ultra-violet light)							
T12							
20	F20T12/BLB	Blacklight Blue	600	9000	6	34747	2
40	FT40T12/BLB	Blacklight Blue	1200	20000	6	25618	2



## Circuit diagrams

### 1000 Watt CID Lamp Circuit Diagram

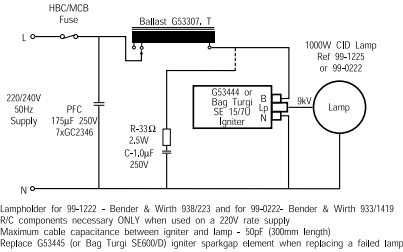

### 1000 Watt CSI/CID Hot-Restart Lamp Circuit Diagram

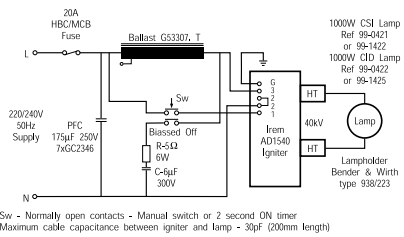

### 1200 Watt CID Hot-Restart Lamp Circuit Diagram

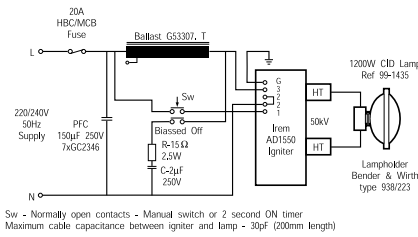

### 2500 Watt CID Hot-Restart Lamp Circuit Diagram

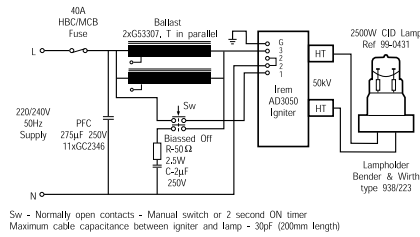

### 200 Watt CID Hot-Restart Lamp Circuit Diagram

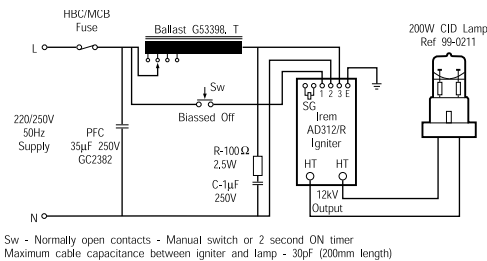

### 400 Watt CSI Lamp Circuit Diagram

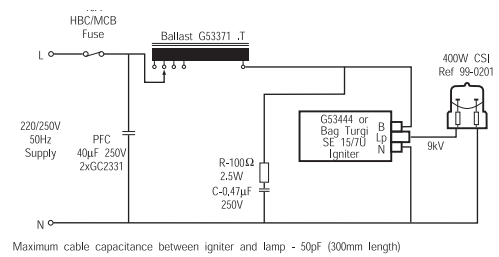

### 575 Watt CID Lamp Circuit Diagram

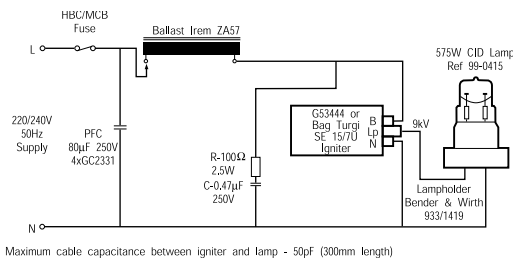

### 1000 Watt CSI Lamp Circuit Diagram

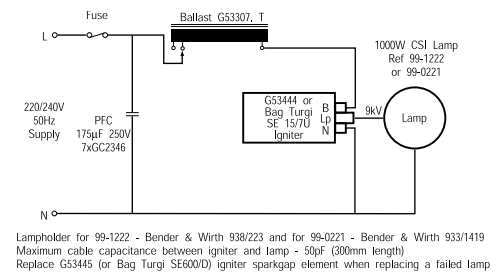

## Explanation of codes

Lamps listed in this catalogue are those designed for use as follows:

**A1 Prefix** – L.I.F. (Lighting Industries Federation) reference indicates lamps which were primarily designed for use with slide, film and overhead projectors.

**ANSI Codes** – These are 3-letter codes assigned by the American National Standards Institute. They provide a system for assuring mechanical and electrical interchangeability among similarly coded lamps from various manufacturers.

**CP Prefix** – Lamps designed for use in conjunction with film balanced for 3200K. These are single ended types intended for use in Fresnel/ellipsoidal luminaires etc.

**P2 Prefix** – Again for use with 3200K film stock for open faced luminaires and video sun guns.

**P1 Prefix** – For use with 3400K film stock.

**T Prefix** – Lamps intended for theatre luminaire applications. These are of lower colour temperature (2900 - 3050K) and longer life than the often similar CP types above.

**C.S.I.** – Discharge lamps with a colour temperature of around 4000K for outside broadcast and follow spot use.

**C.I.D.** – Discharge lamps with a colour temperature of 5500–6000K for location filming and applications such as disco lighting where a very bright compact source is required.

### Special and Experimental Lamps

In addition to these standard ranges, a number of similar types are available to special order and in most cases, a minimum order quantity will apply. These include non-standard voltage ranges of some types e.g. 100V, 100/115V, 120V and also a number of types which have the GE "HX" or "THE" prefix.

### Lamp Bases

The listings use the IEC International designations for lamp bases. Where appropriate, alternative local descriptions are appended.

## Incandescent tungsten halogen lamps

### Filament Format

The listings use the following codings for filament shape:

**S.C.** – Axial Single Coil – equivalent to ANSI C8

**C.C.** – Axial Coiled Coil – equivalent to ANSI CC8

**M.P.** – Monoplane Grid – equivalent to ANSI C13

**B.P.** – Biplane Grid – equivalent to ANSI C13D

**T.F.** – Twin Monoplane Grid – equivalent to ANSI 2C13

**S.C.H** – Single Coil Hexagonal – equivalent to ANSI 6-C8

**S.C.S** – Single Coil Square – equivalent to ANSI 4-C8

### CP Range of Lamps for Fresnel and Spotlight Fittings

As the result of extensive and sustained development work, much of it original, GE is able to offer a comprehensive range of lamps of quartz construction, operating on the tungsten halogen principle for all Television Studio, 'motion picture', and Theatre lighting purposes.

GE has been strongly supported by the television and film industries in its decision to discontinue glass lamps for studio lighting purposes. This is because the industry has appreciated the financial advantages of quartz halogen lamps, their reliability and virtually constant colour temperature.

The increase in the use of the lamps we now manufacture is due to the GE policy of exploiting the important advantages of compact size offered by quartz halogen construction. As a result GE is able to supply quartz halogen lamps for use in Fresnel and spotlight fittings from 300 watts to 24,000 watts. These lamps employ a wide range of commonly accepted bases. This gives fittings manufacturers a comprehensive range of compact lamps and permits the construction of smaller, lighter and more efficient luminaires.

## Glossary of basic product information

### Rated Average Life

Average life ratings of Projection Lamps are based on closely controlled laboratory tests of lamps, at their rated voltage, over a long period of production time. Rated Average Life is not necessarily the same as service life; mechanical shock and vibration, voltage fluctuation, temperature and other environmental factors may result in shorter service life. As with any average value, some individual lamps may operate longer, and some may operate shorter, than their Rated Average Life. (Supply voltage variation can significantly affect lamp life; see comments under Lamp Life Ratings, page 146).

### 'T' Class Lamps for Theatre Spotlight Fittings

With this group of lamps GE is continuing their policy of developing quartz halogen lamps. These lamps operate at a lower colour temperature than the CP range. An average life of a remarkable 750 hours is achieved for most of the GE range. Similar cost savings to those offered by quartz halogen CP lamps are now presented by the quartz halogen 'T' range.

### Typical Working Distance

For Multi-Mirror® and other reflector lamps and MARC™ lamps, the Working Distance shown is the distance from the front surface of the reflector rim to the film plane, in the optical system for which the lamp was first designed. In most cases, it provides a uniform plane of light for the intended aperture.

### Light Centre Length (LCL)

This dimension defines the location of the filament in relation to the lamp base. It is measured from the geometric centre of the filament to a specified point on, or plane through, the base. Light Centre Length is subject to manufacturing tolerances.

### Maximum Overall Length (MOL)

This dimension includes the lamp bulb and all rigid parts of the base. Since the listed lengths include maximum tolerances, actual lamps are generally slightly shorter.

### Approximate Initial Lumens

The value shown is based on spherical photometry, at rated voltage, of lamps that have been seasoned for approximately 15% (or a minimum of 2 hours) or more of their rated average life.

### Approximate Colour Temperature

The radiation within the visible spectrum from tungsten filament lamps is similar in spectral distribution to that from a "blackbody" at specific colour temperatures. The Colour Temperatures shown are approximate initial values in Kelvin (K) for lamps operated at rated voltage. As the spectral distribution of MARC lamps does not conform to that of a "blackbody", the values shown are 'correlated' colour temperatures expressed in Kelvin.

### Important Notice

This catalogue contains accumulated data to October 2008. Additional information is constantly being uncovered through research and testing, which may modify the data given herein. This is particularly true of newer lamps. For the latest lamp design data and information, contact your General Electric Lamp Representative. The data and suggested applications contained in this catalogue, as well as any additional information our representative may be able to furnish, are for general information only and are not intended and should not be taken as representations or warranties as to the suitability of a lamp for any particular attention or use in any particular equipment, nor are our representatives authorised to make any such representations or give any such warranties. Applications and conditions of use are many and varied, and beyond our control. We cannot possibly have the same degree of knowledge that the purchaser has with respect to the design of their equipment and the conditions of its use. Therefore, it is up to the purchaser to make their own determination as to the suitability of a lamp for his intended application or use and to assume the responsibility for that determination. General Electric desires to supply the best possible products at all times. For this reason, General Electric reserves the right to make changes in its products when it believes such changes will improve its products.



### Operating Temperature of Tungsten Halogen Studio Lamps

The following maximum and minimum temperatures are suggested for optimum life. Operation outside these figures will not necessarily cause immediate failure but will affect life adversely to an increasing extent.

Seal – 450° C maximum

Above this figure the sealing foil oxidises at a rate increasing with temperature and is frequently the cause of short life due to seal failure.

Bulb - 250° - 800° C

Outside this range the halogen cycle becomes less efficient and blackening may occur. Temperatures above 1200° C will cause the bulb to soften.

Pins - 350° C maximum

Above this figure the plating on the pins may lose adhesion and the contact will deteriorate. Such deterioration may form local hot spots which rapidly worsen and may result in arcing and irreparable damage to both lamp and holder. Should signs of this be evident on removal of a failed lamp, it is important that a good contact is restored by replacing the lampholder before the next lamp is fitted. Otherwise the new lamp will rapidly fail in a similar manner."

### Fusing of Tungsten Halogen Studio and Theatre Lamps

A lamp normally fails at end of life by fusing of the filament. Often an arc then forms and as there is little resistance to limit the current this rises to a very high value which if maintained can result in a serious overload on the envelope and seals. This might result in the lamp shattering. A quick acting high breaking capacity fuse must be connected in the supply line in all applications. Suitable types are given in BS88 (IEC 60269), IEC 60127 or IEC 60241.

## Discharge lamps

Even with all the advances which have been made in tungsten halogen technology in recent years there are still occasions, particularly whilst working on location, when handling the number of fittings required to give an acceptable illumination level can be a logistical headache. One GE metal halide discharge lamp can provide more light than three tungsten halogen lamps of the same rating. That means one third the power consumption and one third the number of fittings to transport and aim. The potential for major cost savings is clear. GE Lighting has led the way in adapting discharge lamps for use in the performing arts. The company was the first and for many years the only manufacturer to offer metal halide lamps in the compact, single ended capsule format. The minimal dimensions of these lamps can be incorporated into fittings which are much smaller than corresponding luminaires using

double ended lamps of the same power. With a near point light source excellent optical control is possible. Compact iodide lamps are also available in a sealed beam format. With the light source carefully positioned in the reflector, optimum optical performance is guaranteed. The nitrogen filling gas in the outer bulb prevents oxygen attacking the seal of the inner capsule and so increases the life of the lamp dramatically. All CID discharge studio and stage lamps are dimmable to 50% of peak lumens and the great majority are available in hot restrike versions for applications where frequent changes in lighting levels are required. All lamps will re-strike within ten minutes of switch off.

### Operating Temperature of Discharge Studio Lamps

The following maximum and minimum temperatures are suggested for optimum life. Operation outside of these figures will not necessarily cause immediate failure but will effect life adversely to an increasing extent.

#### Cap/bulb interface capsule lamps - 450° maximum

Above this figure the sealing foil oxidises at a rate increasing with temperature and is frequently the cause of short life due to seal failure.

#### Bulb

capsule lamps 700° - 1000°C

sealed beam lamps 150° - 400°C

Above 1000°C, quartz may devitrify, which will cause the arc tube to leak, loss of dose will cause the arc tube to operate below the minimum temperature, the metal halides will not vaporise as required, and lamp performance will be impaired.

#### Pins - 350°C maximum

Above this figure the plating on the pins may lose adhesion and the contact will deteriorate. Such deterioration may form local hot spots which rapidly worsen and may result in arcing and irreparable damage to both lamp and holder. Should signs of this be evident on removal of a failed lamp, it is important that a good contact is restored by replacing the lampholder before the next lamp is fitted, otherwise the new lamp will rapidly fail in a similar manner.

N.B. For sealed beam lamps - to ensure that the above conditions are met, it is important that the lamp does not operate above 400°C even in an enclosed fitting.

### Fusing of Discharge Studio and Theatre Lamps

A quick acting high breaking capacity fuse must be connected in the supply line in all applications. Suitable types are given in BS88 (IEC 60269), IEC 60127 or IEC 60241.

## Turn on time of studio lamps

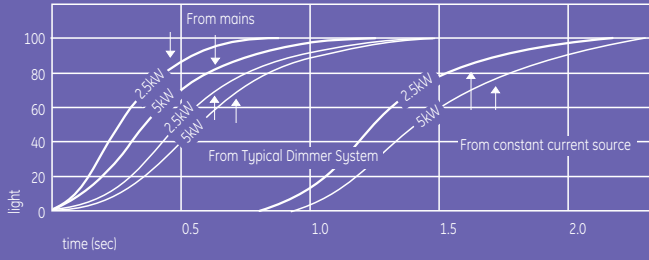

## Fusing of Tungsten Halogen Studio and Theatre Lamps

Lamp power (watts)	Fuse (rated current) (amps)		
	100-115V	115-130V	220-250V
500	6	6	4
650	10	6	4
1000	16 (15 UK)	10	6
1500	20	16 (15 UK)	10
2000	25 (30 UK)	25 (30 UK)	10
2500	35 (30 UK)	25 (30 UK)	16 (15 UK)
5000	63 (60 UK)	50	25 (30 UK)
10000	125	100	50

### Variation of light output and wattage with applied voltage for a typical studio lamp

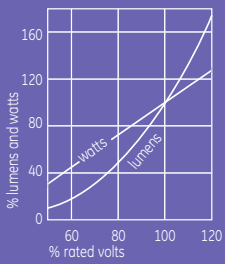

### Colour temperature variation with voltage for typical studio lamp

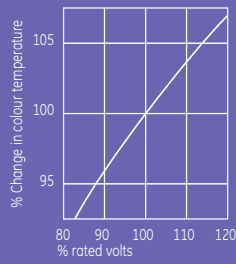

### Typical life variation against operation voltage

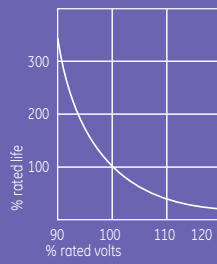

### Spectral distribution of luminous flux (lumens) for typical theatre and studio lamp

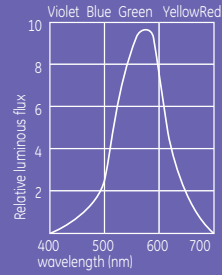

### Total spectral energy distribution of typical studio lamp

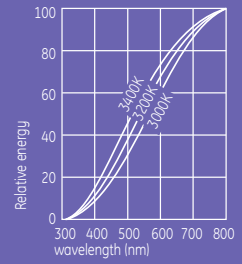

### Spectral distribution of luminous flux (lumens) for CSI discharge lamps

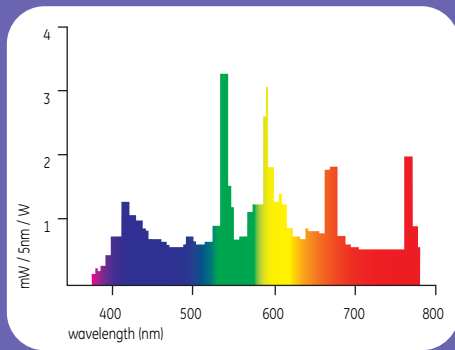

### Spectral distribution of luminous flux (lumens) for CID discharge lamps

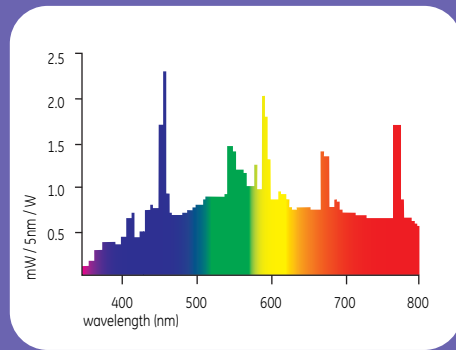



GE Specialty Lighting provides a wide range of lamps for a variety of applications including airfield, aircraft, transportation, heating, medical, bacterial destruction and shatter-protection to meet the demands and applications needs of OEMs and end users.

If the application or lamp type you need does not appear here then contact us to find out the latest developments in the GE Specialty range.



## Content

Blacklight Blue	152
UVA Biax Range	152
CovRguard Lamps	152
T8 Cold Temperature	153
Aquarium and Reptile	153
Germicidal	153
Biax	154
Quartz Heat	154
Jacketed Quartz Heat	155
Infrared Quartz Heat	155
Airfield Lighting	155
Medical Lamps	155



## Product identification

The following glossary of terms and descriptions can help you when checking specialty lamp specifications and how to use the order codes when ordering products. Within each product line, lamps are divided into families – within families, lamps are listed by wattage.

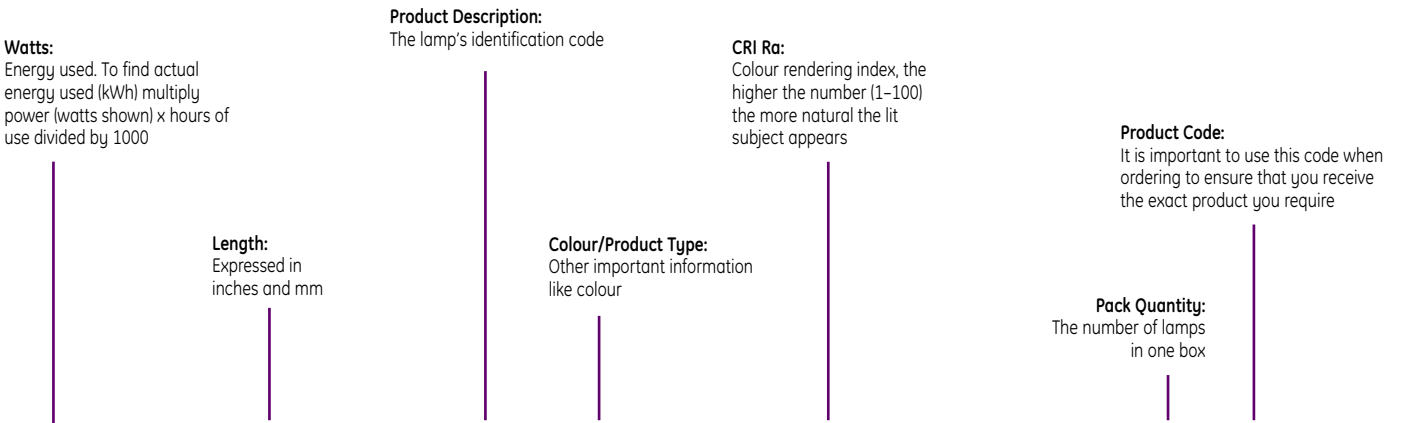

### T5 Blacklight Blue

Watt	Length Ft	Length mm	Product Description	Color Product Type	CCT K	CRI Ra	Rated Average Life Hours	Initial lumens	Pack Qty	Product Code
T5 (ø16mm – 5/8")										
4	6in	150	F4W/BLB	Blacklight Blue	-	-	5000	-	25	39882
6	9in	225	F6W/BLB	Blacklight Blue	-	-	5000	-	25	39883
8	12in	300	F8W/BLB	Blacklight Blue	-	-	5000	-	25	39884

**Lamp:** Description of lamp type, and product features

**CCT K:** Colour temperature – Kelvin. The visual warmth or coolness of the light. The higher the number the whiter or cooler the light appears

**Rated Average Life:** The point in time when 50% of installed lamps are still burning

**Initial Lumens:** Light output after the initial 100 hours of operation

### F 4W / BLB

Identifies lamp as fluorescent

Identifies product type

Identifies lamp wattage





## Blacklight Blue



Watt	Length Ft	Length mm	Product Description	Colour/Product Type	CCT K	CRI Ra	Rated Average Life Hours	Initial lumens	Pack Qty	Product Code
T5 Blacklight Blue, T5 (ø16mm- 5/8")										
4	6in	150	F4W/BLB	Blacklight Blue	-	-	5000	-	25	39882
6	9in	225	F6W/BLB	Blacklight Blue	-	-	5000	-	25	39883
8	12in	300	F8W/BLB	Blacklight Blue	-	-	5000	-	25	39884
T12 Blacklight Blue, T12 (ø 38mm - 1 1/2")										
20	-	600	F20W/BLB	Blacklight Blue	-	-	9000	-	6	34747
40	-	1200	F40W/BLB	Blacklight Blue	-	-	20000	-	6	25618
T8 Black Light 350nm										
15	18in	450	F15WBL 350	Blacklight	-	-	7500	-	25	16941

## UVA Biax Range



Nominal Power (W)	Length (mm)	Product Description	Cap	Nominal Lamp Voltage (V)	Nominal Lamp Current (mA)	Peak Wave-length (nm)	Initial UVA Irradiance <sup>1</sup> (mW/cm <sup>2</sup> @ 20cm)	Median Life (hours)	Pack Size	Product Code
Biax™ Electronic 2 pin Internal Starter										
9	167	F9BX BL G23 Blacklight	G23	60	170	368	440	10000	10	42935
11	237	F11BX BL G23 Blacklight	G23	91	155	368	670	10000	10	42936
13.4	177.5	F13BX BL GX23 Blacklight	GX23	58	285	368	630	10000	10	42937
Biax™ D 2 pin Internal Starter										
26	169.5	F26DBX BL G24d-3	G24d-3	105	325	368	630	10000	10	42938
Biax™ L 4 pin External Starter Required										
24	326.8	F24BX BL 2G11	2G11	87	345	368	980	10000	10	42939
36	421.8	F36BX BL 2G11	2G11	107	435	368	1280	10000	10	42940
55	541.8	F55BX BL 2G11	2G11	101	550	368	1630	10000	10	42941

## Cov-R-Guard™ Polylux XLR™ and Starcoat



Watt	Length Ft	Length mm	Product Description	Colour/Product Type	CCT K	CRI Ra	Rated Average Life Hours	Initial lumens	Pack Qty	Product Code
T8 Cov-R-Guard™ Polylux XLR™ - with Polycarbonate Shield										
T8 ( ø26mm - 1") 58W and 70W have FEP coating										
18	2ft	600	F18W/830	CVG/XLR 830	2950	85	15000	1300	25	17203
			F18W/835	CVG/XLR 835	3400	85	15000	1300	25	17204
			F18W/840	CVG/XLR 840	4000	85	15000	1300	25	17205
36	4ft	1200	F36W/830	CVG/XLR 830	2950	85	15000	3250	25	17208
			F36W/835	CVG/XLR 835	3400	85	15000	3250	25	17202
			F36W/840	CVG/XLR 840	4000	85	15000	3250	25	17209
58	5ft	1500	F58W/830	CVG/XLR 830	2950	85	15000	5050	25	12403
			F58W/835	CVG/XLR 835	3400	85	15000	5050	25	12405
			F58W/840	CVG/XLR 840	4000	85	15000	5050	25	12407
70	6ft	1800	F70W/835	CVG/XLR 835	3400	85	15000	6100	25	12423
			F70W/840	CVG/XLR 840	4000	85	15000	6100	25	12424

Polylux XLR™ Cov-R-Guard Rated Average Life on HF Electronic gear: 20000 hrs

### T5 covGuard® High Output Starcoat®



24	549	F24W/T5/830/ECO/COVG	-	3000	85	30000	1950	40	71000
	549	F24W/T5/835/ECO/COVG	-	3500	85	30000	1950	40	70998
39	549	F24W/T5/841/ECO/COVG	-	4100	85	30000	1950	40	70997
	549	F24W/T5/850/ECO/COVG	-	5000	85	30000	1850	40	70999
39	549	F24W/T5/865/ECO/COVG	-	6500	85	30000	1800	40	70996
	849	F39W/T5/830/ECO/COVG	-	3000	85	30000	3400	40	70995
39	849	F39W/T5/835/ECO/COVG	-	3500	85	30000	3400	40	70994
	849	F39W/T5/841/ECO/COVG	-	4100	85	30000	3400	40	70993
39	849	F39W/T5/850/ECO/COVG	-	5000	85	30000	3250	40	70991
	849	F39W/T5/865/ECO/COVG	-	6500	85	30000	3200	40	70990
54		F54T5/830/HO/ECO/COVG	-	3000	85	30000	4560	40	48433
		F54T5/835/HO/ECO/COVG	-	3500	85	30000	4560	40	48436
		F54T5/841/HO/ECO/COVG	-	4100	85	30000	4560	40	48458
		F54T5/850/HO/ECO/COVG	-	5000	85	30000	4465	40	80311
		F54T5/865/HO/ECO/COVG	-	6500	85	30000	4465	40	48469



## Arctic Cold Temperature T8 Fluorescent

Watt	Length Ft	Length mm	Product Description	Colour/Product Type	CCT K	CRI Ra	Rated Average Life Hours	Initial lumens	Pack Qty	Product Code
18	2ft	600	F18T8/835/ARCTIC	-	3500	85	18000	1350	12	31147
			F18T8/840/ARCTIC	-	4100	85	18000	1350	12	31148
36	4ft	1200	F36T8/835/ARCTIC	-	3500	85	18000	3350	16	25763
			F36T8/840/ARCTIC	-	4100	85	18000	3350	16	25764
58	5ft	1500	F58T8/840/ARCTIC	-	4100	85	18000	5800	24	23752
70	6ft	1800	F70T8/835/ARCTIC	-	3500	85	18000	6300	24	16149
			F70T8/840/ARCTIC	-	4100	85	18000	6300	24	23754

Protected from cold temperatures with LEXAN™ jacket

## T8 Aquarium and Reptile

T8 (ø26mm - 1")

15	18in	450	F15T8 F&SA	Fresh & Salt Aqua	-	-	9000	700	10	16965
			F15T8 FA	Fresh Aqua	5000	-	7500	400	10	16977
			F15T8 SW	Salt Water	-	-	7500	210	10	16987
			F15T8 REP	Reptile	6400	82	7500	400	10	17002
18	2ft	600	F18T8 F&SA	Fresh & Salt Aqua	-	-	15000	950	10	16966
			F18T8 FA	Fresh Aqua	5000	-	7500	600	10	16979
			F18T8 SW	Salt Water	-	-	7500	270	10	16988
			F18T8 REP	Reptile	6400	82	7500	550	10	17003
25	2.5ft	760	F25T8 F&SA	Fresh & Salt Aqua	-	-	15000	1350	10	16968
			F25T8 FA	Fresh Aqua	5000	-	7500	805	10	16980
			F25T8 SW	Salt Water	-	-	7500	430	10	16991
			F30T8 F&SA	Fresh & Salt Aqua	-	-	15000	1700	10	16969
30	3ft	910	F30T8 FA	Fresh Aqua	5000	-	7500	1035	10	16981
			F30T8 SW	Salt Water	-	-	7500	540	10	16992
			F30T8 REP	Reptile	6400	82	7500	1100	10	17004
			F36T8 F&SA	Fresh & Salt Aqua	-	-	15000	2350	10	16970
36	4ft	1200	F36T8 FA	Fresh Aqua	5000	-	7500	1425	10	16982
			F36T8 SW	Salt Water	-	-	7500	700	10	16995
			F36T8 REP	Reptile	6400	82	7500	1250	10	17006
			F38T8 F&SA	Fresh & Salt Aqua	-	-	15000	2200	10	16971
38	3.5ft	1060	F38T8 FA	Fresh Aqua	5000	-	7500	1320	10	16984
			F38T8 SW	Salt Water	-	-	7500	650	10	16999

Discharge lamps require control gear.

## Germicidal Soft Glass

Watt	MOL (in) / (mm)	Product Description	Cap	UV Output (Watts)	Average Life Hours	Pack Qty	Product Code
------	-----------------	---------------------	-----	-------------------	--------------------	----------	--------------

Effective in killing Microorganisms  
UV output at 254 nm emits no ozone  
T5

4	5.9/ 150	G4T5	Miniature Bi-pin	0.9	6000	24	15872
6	8.9/ 226	G6T5	Miniature Bi-pin	1.7	6000	24	15873
8	11.9/ 302	G8T5	Miniature Bi-pin	2.3	8000	24	11077
11	8.9/ 226	G11T5	Miniature Bi-pin	2.2	8000	24	29495
16	11.91/302	G16T5	Miniature Bi-pin	3.2	8000	24	16494
39	34.07 / 865	G36T5	Single- pin (Fa8)	12	9000	24	15874
65	62.0 / 1575	G64T5	Single- pin (Fa8)	18	7500	24	15864

T5 4 Pin end cap

11	8.66 / 220	G11T5/4P/SE	Single 4 pin end cap	2.2	8000	24	29500
16	12.61 / 320	G16T5/4P/SE	Single 4 pin end cap	3.4	8000	24	29502
39	33.28 / 845	G36T5/4P/SE	Single 4 pin end cap	12	8000	24	29503
65	61.28 / 1556	G64T5/4P/SE	Single 4 pin end cap	25	8000	24	29504

T8

9.5	13.61 / 345	G10T8	G13 Medium Bi-pin	2.7	8000	24	29498
15	17.78 / 451	G15T8	G13 Medium Bi-pin	4.8	8000	24	11078
25	17.78 / 451	G25T8	G13 Medium Bi-pin	6.9	8000	24	11082
30	35.78 / 908	G30T8	G13 Medium Bi-pin	12.4	8000	24	11080
55	35.78 / 908	G55T8HO	G13 Medium Bi-pin	18	8000	24	15875

# Specialty lamps



## Bi-ax

Watt	MOL (in) / (mm)	Product Description	Cap	UV Output (Watts)	Average Life Hours	Pack Qty	Product Code
Bi-ax T4 Glass							
5	3.35 / 85	GBX5/UVC G23	G23 2-pin	1.0	8000	10	40695
9	5.71 / 145	GBX9/UVC G23	G23 2-pin	2.4	8000	10	40696
11	8.46 / 215	GBX11/UVC G23	G23 2-pin	3.6	8000	10	40700
Bi-ax T6 Glass							
13	6.69 / 170	GBX13/UVC GX23	GX23 2-pin	3.6	8000	10	40703
18	8.8 / 225	GBX18/UVC/2G11	2G11 4-pin	5.3	8000	10	40704
36	16.33 / 415	GBX36/UVC/2G11	2G11 4-pin	12	8000	10	40705
55	21.1 / 535	GBX55/UVC/2G11	2G11 4-pin	16.5	8000	10	15885/40706

Discharge lamps require control gear.



## Quartz Heat

Watts	Volts	Bulb	Base	Product Description	CCT K	MOL mm	Rated Average Life Hours	Filament Design	Pack Qty	Product Code	Additional Information
375	115-125	T3	Slv	QH375T3/CL	2400	223.8	5000	C-8	12	21337	Infrared ( 1 )
500	120	T3	Slv	QH500T3/CL	2400	223.8	5000	C-8	12	21788	Infrared, Clear ( 1 )
500	120	T3	R7S	QH500T3/CL/7	2400	220.5	5000	C-8	12	21787	Infrared ( 1 )
1000	200-220	T3	Slv	QH1000T3/CL	2400	351	5000	C-8	12	22355	Infrared ( 1 )
1000	230-250	T3	Slv	QH1000T3/CL	2400	351	5000	C-8	12	22357	Infrared ( 1 )
1000	230-250	T3	Slv	QH1000T3/CL/1	2400	301	5000	C-8	12	22358	Infrared, Clear, Horizontal ( 1,2 )
1000	230	T3	Slv	QH1000T3/2CL/HT	2400	351	5000	C-8	12	22365	Infrared, Clear, High Temp, Constr, Horizontal ( 2 )
1200	144	T3	Slv	QH1200T3/CL	2450	223.8	5000	C-8	12	22531	Infrared, Clear, Horizontal ( 1,2,3 )
1200	144	T3	Slv	QH1200T3/CL/HT	2450	223.8	5000	C-8	12	22532	Infrared, Clear, High Temp, Constr., Horizontal ( 2 )
1600	200	T3	Slv	QH1600T3/CL	2350	503	5000	C-8	12	22686	Infrared, Horizontal ( 1 )
1600	230-250	T3	R7S	QH1600T3/CL/7	2400	498.4	5000	C-8	12	22691	Infrared, Horizontal ( 1 )
1600	230-250	T3	Slv	QH1600T3/CL	2400	503	5000	C-8	12	22688	Infrared, Clear, Horizontal ( 1 )
2000	230	T3	Slv	QH2M/T3/1CL/HT	2450	303	5000	C-8	12	22789	Infrared, Clear, High Temp, Constr.
2000	230-250	T3	Slv	QH2M/T3/1CL/HT/VB	2450	303	5000	C-8	12	15551	Infrared, Clear, High Temp, Constr., Universal ( 2, 3 )
2000	220-250	T3	Slv	QH2MT3/CL/VB	2450	350.5	5000	C-8	12	18668	Infrared, Clear, Universal ( 3 )
2000	230-250	T3	Slv	QH2M/T3/CL/HT	2450	350.8	5000	C-8	12	22790	Infrared, Clear, High Temp, Constr., Horizontal ( 2 )
2000	230-250	T3	CER	QH2MT3/CL/HT/R	2450	352.5	5000	C-8	12	12716	Infrared, Clear, High Temp, Horizontal, Reflector 170 ( 2 )
2500	460-500	T3	Slv	QH2500T3/CL	2400	731	5000	C-8	12	22838	Infrared, Clear, Horizontal ( 1 )
2500	460-500	T3	R7S	QH2500T3/CL/7	2400	727	5000	C-8	12	22837	Infrared, Clear, Horizontal ( 1 )
3650	480	T3	Slv	QH3650/CL/5	2500	1057	5000	C-8	12	10872	Infrared, Horizontal ( 1 )
3800	550-600	T3	Slv	QH3800/CL	2500	1062	5000	C-8	6	22875	Infrared, Horizontal ( 1 )
3800	550-600	T3	Slv	QH3800T3/CL/VB	2500	1062	5000	C-8	6	22878	Infrared, Clear, Universal ( 1, 3 )
5000	575-625	T3	Slv	QH5M/T3/1CL/HT	2500	731.8	5000	C-8	12	22900	Infrared, Clear, High Temp, Constr., Horizontal ( 1,2 )
European Industrial Infrared Quartz Heat											
1000	235	T3		QH1MT3/CL/MS-235V	2500	483	5000	C-8	12	21376	Clear, Metal Strap Connector Philips Equivalent - 13195X
1000	235	T3		QH1MT3/CL/R/MS-235V	2500	483	5000	C-8	12	21377	White Reflector, Metal Strap connector Philips Equivalent - 13195X-98
1000	235	T3		QH1MT3/CL/R-235V	2500	357.5	5000	C-8	12	21378	White Reflector, Ceramic base, Flying leads Philips Equivalent - 13195Z-98



## Jacketed Quartz Heat

Watts	Volts	Bulb	Base	Product Description	CCT K	MOL mm	Rated Average Life Hours	Filament Design	Pack Qty	Product Code	Additional Information
Jacketed 500	230-240	Jacketed DEQ	Special	HH 210 500W CLEAR 230-240V	2450	218	5000	C-6	10	20089	Clear Jacketed
1000	230-240	Jacketed DEQ	Special	HH 450 1000W RUBY 230-240V	2450	348	5000	C-6	10	20091	Ruby Jacketed
1500	230-240	Jacketed DEQ	Special	HH 451 1500W RUBY 230-240V	2450	348	5000	C-6	10	20092	Ruby Jacketed
2000	230-240	Jacketed DEQ	Special	HH 804 2000W RUBY 230-240V	2450	348	5000	C-6	10	20093	Ruby Jacketed

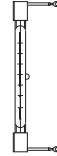

## Infrared Quartz Heat Lamp – Ruby Slim

Watts	Volts	Cap	Length mm	Product Description	Average Rated Life	Pack Size	Product Code
750	230-240	RX7s	202.8	QH 750W 230-240V Ruby Slim	5000	10	40723
750	120	RX7s	202.8	QH 750W 120V Ruby Slim	5000	10	42739
1300	230-240	RX7s	254	QH 1300W 230-240V Ruby Slim	5000	10	42740
1300	120	RX7s	254	QH 1300W 120V Ruby Slim	5000	10	42741

## Airfield Lighting

Watts	Lumens	Bulb	Base	Product Description	CBCP	MOL mm	Average Life Hours	Filament Design	Pack Qty	Product Code	Additional Information
Airport & Airfield 200	5000	T4	Special 1" Ribbon Leads	Q6.6A/T4/5CL		76	500	CC-8	12	23857	Clear, Airport
200	5150	T4	D.C. Bay	Q6.6AT4/DCR		64	500	CC-6	12	23860	Clear, Airport, Ringed
200		PAR56	Scrw Term	Q6.6A/PAR56/3	200000	114	1000	CC-6	12	33279	PAR, Airport, BDTH
300		PAR56	Mog End Pr	Q20A/PAR56/C		127	500	CC-6	12	15482	PAR, Airport, Teflon Coated, Burn Position:Any
499		PAR56	Scrw Term	Q20A/PAR56/3	330000	114	500	CC-6	12	23863	PAR, Airport, BDTH
45	760		Mycalex cap & Prefocus collar	AF6/2 6.6A 45W		54	600	Sgl Coil Flat Grid	100	88420	Clear, Airfield, Horizontal Burn
100	2100		Mycalex cap & Prefocus collar	AF 6/5T 6.6A 100W		60	600	Sgl Coil Flat Grid	100	88417	Clear, Airfield, Horizontal Burn
200	4800		Mycalex cap & Prefocus collar	AF7/2 6.6A 200W		54	600	Sgl Coil Flat Grid	100	88413	Clear, Airfield, Horizontal Burn
36		MR11	Flying Leads	THE 436 6A 36W				CC-6	10	26340	Airfield Apron and Taxi way

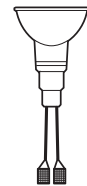

Watts	Lumens	Bulb	Base	Product Description	MOL mm	Average Rated Life	Filament Design	Pack Qty	Product Code for Male Connector	Product code for Female terminal
45	800	T4	PK30d	Q6.6A45PK30d	13.5	1000	C8	10	80583	80587
100	2700	T4	PK30d	Q6.6A100PK30d	13.5	1000	CBAR-6	10	80584	80588
150	3600	T4	PK30d	Q6.6A150PK30d	13.5	1000	CBAR-6	10	80585	80589
200	4800	T4	PK30d	Q6.6A200PK30d	13.5	1000	CC6	10	80586	80590

Robust and shock resistant, LEDs leave traditional lamps in the dark.

Up to 90% energy cost savings, a long life of up to 50,000 hours and minimised maintenance costs.

Light-emitting diodes (LEDs) are compound semi-conductor devices that convert electricity to light. Invented by GE scientists in the 1960s LEDs stand out because unlike lamps that can shatter, they are robust and highly resistant to shock and vibration. Due to the solid-state nature of LEDs, there are no filaments to break, no moving parts to fail and no glass components of any kind.



## LED LOW WATT RANGE

Watt	Volt	Cap	Description	Pack Qty	Hz	Service life	Product Code
1	220-240	GU10	LED GU10 1W 220-240V WHITE	10	50/60	6000	96736
1	220-240	GU10	LED GU10 1W 220-240V RED	10	50/60	6000	96737
1	220-240	GU10	LED GU10 1W 220-240V BLUE	10	50/60	6000	96738
1	220-240	E14	LED PAR16 E14 1W 220-240V WHITE	10	50/60	6000	96740

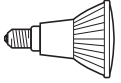

## VIO LED

1.2	500	MOLEX	LED/Vio/1.2W/730	10		50000	73357
1.2	500	MOLEX	LED/Vio/1.2W/735	10		50000	73355
1.2	500	MOLEX	LED/Vio/1.2W/741	10		50000	73353
1.2	500	MOLEX	LED/Vio/1.2W/830	10		50000	73351
1.2	500	MOLEX	LED/Vio/1.2W/835	10		50000	73349
1.2	500	MOLEX	LED/Vio/1.2W/841	10		50000	73347
1.2	500	MOLEX	LED/Vio/3.6W/730	10		50000	73356
1.2	500	MOLEX	LED/Vio/3.6W/735	10		50000	73354
1.2	500	MOLEX	LED/Vio/3.6W/741	10		50000	P73352
1.2	500	MOLEX	LED/Vio/3.6W/830	10		50000	73350
1.2	500	MOLEX	LED/Vio/3.6W/835	10		50000	73348
1.2	500	MOLEX	LED/Vio/3.6W/841	10		50000	73346
			LED/Vio/Con			POA	73738



# Glossary

## A

### Additional Information

Typical application and/or other important information including footnotes, operating information, features and benefits.

### Amperes ("Amps")

A measure of electrical current. In incandescent lamps, the current is related to voltage and power as follows: Current (Amps) = Power (Watts) / Voltage (Volts)

### American National Standards Institute (ANSI)

A consensus organization which coordinates voluntary standards for the physical, electrical and performance characteristics of lamps, ballasts, luminaires and other lighting and electrical equipment.

### ANSI Ballast Type

Ballast type used to operate lamp.

### ANSI Codes

These are 3-letter codes assigned by the American National Standards Institute. They provide a system of assuring mechanical and electrical interchangeability among similarly coded lamps from various manufacturers. General Electric uses the assigned ANSI Codes as Lamp Ordering Codes for most Projection Lamps.

### [Primary] Application

This column indicates the original primary application of the lamp. However, lamps can be, and often are, used in other types of equipment where their design features meet the requirements of the application.

### [Effective] Arc Length

In High Intensity Discharge lamps this is the length of the arc that you can see outside of the bulb.

### Atmosphere

This field designates the type of gas or vacuum the filament operates within. Gas filled lamps are more efficient than vacuum lamps.

## B

### Ballast

An auxiliary piece of equipment designed to start and to properly control the flow of power to discharge light sources such as fluorescent and high intensity discharge (HID) lamps. Some lamps require the ballast to have thermal protection.

### [ANSI] Base or Socket

The type of base or socket. For Incandescent and Halogen lamps, when Footnote 23 or BB (Brass Base) appears in the Lamp Designation or Description column, the lamp is supplied only with a brass base. If Brass Base (Footnote 23 or BB) does not appear, the lamp is supplied only with an aluminum base. For Halogen PAR lamps, when Footnote 55 or NP (Nickel Plated) appears in the Lamp Designation or Description column or in the Base Description, the lamp is supplied only with a Nickel Plated Brass Base. Brass Bases and Nickel Plated Brass Bases are recommended for outdoor lighting applications.

### [Max] Base Temperature

The maximum operating temperature of the base in Celsius.

### [Max] Base Temperature Rise

The maximum increase in temperature from ambient temperature to operating temperature in the base.

### Beam Angle

The angular dimension of the cone of light from the reflectorized lamps (such as R and PAR types) encompassing the central part of the beam out of the angle where the intensity is 50% of maximum. The beam angle sometimes called the "beam spread" is often part of the ordering code of reflectorized lamps. Example: The GE Lamp 50PAR30/HIR/NFL25° is a 50 watt PAR30 narrow flood lamp with a beam angle of 25 degrees. Generally, beam angles 25 degrees and greater are considered Flood, while angles less than 25 degrees are considered Spots. See also Field Angle.

### [Approximate] Beam Spread

For reflector type lamps. The total angle of the directed beam (in degrees horizontal or vertical) to where the intensity of the beam falls to 50% or 10% of the maximum candlepower value as indicated.

### Biax®

GE trademark for the biaxial family of high-efficiency and long life compact fluorescent bulbs.

### Blacktop

Whether or not the top of the miniature lamp has a blacktop coating. The coating is used to control unwanted brightness or glare.

### Bulb Material or Coating

The type of glass (or quartz) used in the glass envelope surrounding the light source. The material can also have coatings applied to achieve particular performances.

### Bulb [size]

Bulb shape followed by its size (the maximum diameter of the bulb expressed in eighths of an inch). For Compact Fluorescent products, "S", "D", "T", and "Q" are used to represent Single, Double, Triple and Quad Biax® sizes. The code also includes a reference such as T4 to represent the size of the tube. Rectangular headlamps are designated as "Rect" and the number of millimeters horizontally.

## C

### Canadian Standards Association (CSA)

An organization that writes standards and tests lighting equipment for performance as well as electrical and fire safety. Canadian provincial laws generally require that all products sold for consumer use in Canada have CSA or equivalent approval.

### Candela (cd)

The international unit (SI) of luminous intensity. The term has been retained from the early days of lighting when a standard candle of a fixed size and composition was used as a basis for evaluating the intensity of other light sources.

### Candlepower

Luminous intensity expressed in candelas. Plots of luminous intensity called candlepower distribution curves are used to indicate the intensity distribution characteristics of reflector type lamps.

### [Mean Spherical] Candlepower

Initial mean spherical candlepower at the design voltage. Mean spherical candlepower is the generally accepted method of rating the total light output of miniature lamps. To convert this rating to lumens, multiply it by 12.57 (4 pi).

### [Approximate] Center Beam Candlepower (CBCP)

For reflector type lamps. Center Beam Candlepower is the intensity (candelas) at the center or maximum intensity of the beam.

### Case quantity or Standard Package Quantity

Number of product units packed in a master case. Also known as Standard Package Quantity.

### Cathode Resistance

Resistance of the cathode in a Fluorescent lamp. It is measured "cold" before the lamp is turned on (Rc) or "hot" after the lamp is turned on (Rh). The ratio of the hot resistance to the cold resistance is also measured (Rh/Rc).



## Chromaticity

Measure to identify the color of a light source, typically expressed as (x,y) coordinates on a chromaticity chart. See Color Temperature

## Coefficient of Utilization

In general lighting calculations, the fraction of initial lamp lumens that reach the work plane. Cu is a function of luminaire intensity distribution, room surface reflectances and room shape.

## Color Rendering Index (CRI)

An international system used to rate a lamp's ability to render object colors. The higher the CRI (based upon a 0-100 scale), the better colors appear. CRI ratings of various lamps may be compared, but a numerical comparison is only valid if the lamps are also rated for the same chromaticity. (See Chromaticity). CRI differences among lamps are not usually significant (visible to the eye) unless the difference is more than three to five points.

## [High] Color Rendering Indicator

Indicates that this is a lamp with high color rendering, which helps objects and persons illuminated to appear more true to life.

## [Correlated] Color Temperature

Originally, a term used to describe the "whiteness" of incandescent lamp light. Color temperature is directly related to the physical temperature of the filament in incandescent lamps so the Kelvin (absolute) temperature scale is used to describe color temperature. For discharge lamps where no hot filament is involved, the term "correlated color temperature" is used to indicate that the light appears "as if" the discharge is operating at a given color temperature. Chromaticity is expressed either in Kelvins (K) or as "x" and "y" coordinates on the CIE standard Chromaticity Diagram. Although it may not seem sensible, a higher temperature color (K) describes a visually cooler, bluer light source. Typical color temperatures are 2800K (incandescent), 3000K (halogen), 4100K (cool white or SP41 Fluorescent), and 5000K (daylight-simulating fluorescent colors such as Chroma 50 and SPX 50).

## Compact Fluorescent Lamp (CFL)

The general term applied to families of smaller diameter fluorescent lamps (e.g. the GE T4 and T5), some of which have built in ballasts and medium screw bases for easy replacement of incandescent lamps. Fluorescent bulbs use approximately 2/3 to 4/5 less electricity than regular incandescent bulbs with comparable lumen ratings and also last 20 times longer. They produce warm white tones that closely duplicate incandescent light.

## [Max Current] Crest Factor

The ratio of the peak lamp current to average lamp operating current (RMS).

## Current Type (AC/DC)

Whether the operational voltage is based on Alternating Current or Direct Current.

## D

## Depth of Lamp

Referenced by IEC as Dimension B.

## Dimmable

Whether or not the lamp lumens can be varied while maintaining reliability.

## Distance Between Legs

For U-shaped Fluorescent lamps, this measurement is the average distance between the inner walls of the legs.

## Distance Outside Legs

For U-shaped Fluorescent lamps, this measurement is the average distance to the outside of each leg.

## Distance Between Leg Centers

For U-shaped Fluorescent lamps, this measurement is the average distance between the centers of each leg.

## DOT Type

The US Department of Transportation lamp number stamped in the glass lens or on the base of headlamps.

## E

## ECE R37 Code

European Common Market Regulation 37 standard lamp number.

## [Maximum] Eccentricity

In High Intensity Discharge lamps the Bulb to Arc Angle is the angle off of center between electrodes and bulb. The Bulb to Base Angle is the angle off of center that the bulb is from the base.

## Efficacy

See Luminous Efficacy.

## Electromagnetic Spectrum

A continuum of electric and magnetic radiation that can be characterized by wavelength or frequency. Visible light encompasses a small part of the electromagnetic spectrum in the region from about 380 nanometers (violet) to 770 nanometers (red) by wavelength.

## Electronic Ballast

A short name for fluorescent high frequency electronic ballast. Electronic ballasts use solid state electronic components and typically operate fluorescent lamps at frequencies in the range of 25-35 kHz. The benefits are: increased lamp efficacy reduced ballast losses and lighter, smaller ballasts compared to electromagnetic ballasts. Electronic ballasts may also be used with HID lamps, but the circuits are quite different.

## Elliptical Reflector (ER) Lamp

An incandescent lamp with an elliptically-shaped reflector. This shape produces a focal point directly in front of the lamp which reduces light absorption in some types of luminaires. It is particularly effective at increasing efficiency of baffled downlights.

## Energy Policy Act (EPACT)

Comprehensive energy legislation passed by the U.S. Congress in 1992. The lighting portion includes lamp labeling and minimum energy efficacy (lumens/watts) requirements for many commonly used incandescent and fluorescent lamp types. Similar legislation is being considered in other parts of the world.

## EPACT Indicator

Means this lamp is Federally regulated for Energy Efficiency. See Energy Policy Act.

## F

## Federal Communication Commission

A U.S. Federal agency which is charged with regulating emissions in the radio frequency portion of the electromagnetic spectrum. For example, a regulation entitled, "Part 18" deals with electromagnetic interference (EMI) from all lighting devices operation at frequencies higher than 9 kilohertz (kHz). Typical electronically ballasted compact fluorescent lamps operate in the range of 24-100 kHz.

## Field Angle

The angular dimension of the cone of light from reflectorized lamps (such as R and PAR types) encompassing the central part of the beam out to the angle where the intensity is 10% of maximum. See Beam Angle.

# Glossary

## Filament (design)

Filaments are designated by a letter combination in which C is a coiled wire filament, CC is a coiled wire that is itself wound into a larger coil, and SR is a straight ribbon filament. Numbers represent the type of filament-support arrangement.

## Fixture required

Describes fixture requirements for HID lamps.

O = Open or Enclosed Fixtures

E = Enclosed Fixtures Only

S = Lamps operated in a vertical position (Base Up or Down)  $\pm 15^\circ$ , can be used in an open fixture. Lamps burned in any other orientation must be used in "enclosed fixtures only".

## Fluorescent Lamp

A high efficiency lamp using an electric discharge through low pressure mercury vapor to produce ultra-violet (UV) energy. The UV excites phosphor materials applied as a thin layer on the inside of a glass tube which makes up the structure of the lamp. The phosphors transform the UV to invisible light.

## Footcandle (fc)

A unit of illuminance or light falling onto a surface. One footcandle is equal to one lumen per square foot. See also Lux

## [Nominal Operating] Frequency

The stated operating frequency in Hz of a discharge lamp.

## G

## Genura™

A GE fluorescent light source of a unique design. Features include a reflector shape, built in high frequency electronic ballast and an electrodeless arc tube. The 23-watt R25 Genura lamp is rated for 1100 initial lumens and 10,000 hours life and is designed to directly replace a 75-watt incandescent reflector lamp.

## H

## Halogen Lamp

A short name for the tungsten-halogen lamp. Halogen lamps are high pressure incandescent lamps containing halogen gases such as iodine or bromine, which allow the filaments to be operated at higher temperatures and higher efficacies. A higher temperature chemical reaction involving tungsten and the halogen gas recycles evaporated particles of tungsten back onto

the filament surface.

## Halogen indicator\*

Indicates if the bulb is a halogen lamp.

## Halogen-IR(HIR)Lamp

GE designation for a new form of high-efficiency tungsten halogen lamp. HIR lamps use shaped filament tubes coated with numerous layers of materials, which selectively reflect and transmit infrared energy and light. Reflecting the infrared back onto the filament reduces the power needed to keep the filament hot.

## Height of Lamp

Referenced by IEC as Dimension C. Also referred to as "Base Face to Top of Lamp".

## High-Intensity Discharge (HID) Lamp

A general term for mercury, metal halide (GE Multi-Vapor, MXR or Arcstream) and high-pressure sodium (GE Lucalox) lamps. HID lamps contain compact arc tubes, which enclose various gases and metal salts operation at relatively high pressures and temperatures.

## High-Pressure Sodium (HPS) Lamp

A generic name for GE's Lucalox lamp. HPS lamps are high intensity discharge light sources, which produce light by an electrical discharge through sodium vapor operating at relatively high pressures and temperatures.

## Hot Restart Time

Time it takes for a High Intensity Discharge lamp to reach 90% of light output after going from on to off to on.

## I

## Illuminance

The "density" of light(lumens/area) incident on a surface. Illuminance is measured in footcandles or lux.

## Incandescent Lamp

A light source which generates light using a thin filament wire (usually tungsten) heated to white heat by an electric current passing through it.

## Infrared Radiation

Electromagnetic energy radiated in the wavelength range of about 770 to 1106 nanometers. Energy in this range cannot be seen by the human eye, but can be sensed as heat by the skin.

## Instant Start

A type of fluorescent lamp-ballast circuit designed to start fluorescent lamps as soon as the power is applied. Originally, instant-start circuits were developed to eliminate separate mechanical starter devices. Slimline fluorescent lamps operate only on instant start circuits.

## K

## Kilowatt Hour (kwh)

The standard measure of electrical energy and the typical billing unit used by electrical utilities for electricity. A 100-watt lamp operated for 10 hours consumes 1000 watt-hours (100\*10) or 1 kilowatt-hour. If the utility charges \$.10/kWh, then the electricity cost for the 10 hours of operation would then be 10 cents (1\*.10).

## L

## Lamp

The term used to refer to the complete light source package including the inner parts as well as the outer bulb or tube. "Lamp," of course, is also commonly used to refer to the type of small light fixture such as a table lamp.

## Lamp Description

The lamp's identification code. For Projection lamps, this is a 3-letter-number code uniquely identifying the lamp for ordering purposes. In some instances, lamps with 3-letter (ANSI) codes are offered in more than one design voltage, in which case the voltage required should also be specified when ordering. Some GE Projection Lamps have an ordering code comprising of two or more 3-letter ANSI codes - such as EM/EKS and DYS/DYV/BHC. The first code is the ANSI code, the secondary codes identify which lamp the multiple-coded lamp can directly replace. Only the first code appears on the lamp itself. Multiple-coded lamps are so-designated by General Electric for the convenience of the customer. In nearly all cases, Miniature and Sealed Beam lamps are marked with a General Electric Trade number recorded with ANSI.

## LIF Code

For SHOWBIZ® lamps, these are assigned by the Lighting Federation of London U.K. They ensure electrical and mechanical interchangeability of similarly coded lamps. LIF codes are divided into groups according to the primary application of the lamps.



## Light

Radiant energy which can be sensed or seen by the human eye. Visible light is measured in lumens.

## [Average Rated] Life

The median time it takes for a lamp to burn out. For example, a 60-watt Soft White Bulb can be expected, on average, to burn for 1,000 hours. Based upon continuous testing of lamps in laboratories, the 1,000 hour rating is the point in time when 50% of the test samples have burned out and 50% are still burning. Unless otherwise noted Fluorescent and CFL life assumes 3 hours average operating time per start. Unless otherwise noted HID life assumes 10 hours average operating time per start

## Light Center Length (L.C.L)

The distance between the center of the filament or arc tube in a lamp and a reference plane-usually the bottom of the lamp base.

## Lumen

The international (SI) unit of luminous flux or quantity of light. For example, a dinner candle provides about 12 lumens. A 60-Watt Soft White incandescent lamp provides 840 lumens.

## [Approximate Initial] Lumens

Initial light output. For Projection lamps, the value shown is based on spherical photometry, at rated voltage, of lamps that have been seasoned for approximately 15% (or minimum of 2 hours) or more of their rated average life.

## [Mean] Lumens

Lamp light output (lumens) at 40% of rated lamp life for Fluorescent, Compact Fluorescent and Metal Halide lamps and 50% of rated life for Mercury and HPS lamps.

## Lumen Maintenance

A measure of how well a lamp maintains its lamp output as it ages. Lumen maintenance is usually provided as a curve. See also Mean Lumens.

## Lumen Per Watt (lpw)

A measure of the efficiency, or, more properly, "efficacy" of a light source. Efficacy is easily calculated by taking the lumen output of a lamp and dividing by the lamp watts. For example, a 100-watt producing 1750 lumens has an efficacy

of 17.5 lumens per watt.

## Luminaire

A complete lighting unit consisting of a lamp (or lamps), ballast (or ballasts) as required together with the parts designed to distribute the light, position and protect the lamp and connect them to the power supply.

## Luminance

Formerly, a measure of photometric brightness. Luminance has a rather complicated mathematical definition involving the intensity and direction of light. It should be expressed in candelas per square inch or candelas per square meter although an older unit, the "footambert," is still sometimes used. Luminance is a measurable quantity where as brightness is a subjective sensation.

## Luminous Efficacy

The light output of a light source divided by the total power input to that source. It is expressed in lumens per watt.

## Lux (lx)

The SI (International) unit of illuminance. One lux is equal to one lumen per square meter. See also Footcandle.

## M

## Maximum Overall Length (M.O.L.) or Nominal Length

The end-to-end measurement of a lamp expressed in inches or millimeters. Since the listed lengths include maximum tolerances, actual lamps are generally slightly shorter. The length of Linear Fluorescent lamps can also be stated from Base Face to Base Face.

## Mean Lumens

The average light output of a lamp over its rated life. For fluorescent and metal halide lamps, mean lumen ratings are measured at 40% or rated lamp life. For mercury, high-pressure sodium and incandescent lamps, mean lumen ratings are measured at 50% of rated lamp life.

## Mercury Lamp

A high-intensity discharge light source in which the light is produced by the radiation from mercury, plus halides of metals such as sodium, scandium, indium and dysprosium. Some lamp types may also use phosphor coatings.

GE trade names of these lamps include: Multi-Vapor, XL, Watt-Miser®, Chromafit and Arcstream.

## Nanometer

A unit of wavelength equal to 10<sup>-9</sup> meters.

## [Gov't] National Stock Number

The standardized part number used by the US Government for procurement.

## O

## OCV

Open Circuit Voltage measured across the lamp. Measured in a variety of ways.

## Operating Position or Burn Position

Mercury and High Pressure Sodium lamps may be operated in any burn position and will still maintain their rated performance specifications. Metal Halide and Low Pressure Sodium lamps, however, are optimized for performance in specific burn positions, or may be restricted to certain burn positions for safety reasons.

U = Universal burning position

HBU = Horizontal -15° to Base Up

HBD = Horizontal +15° to Base Down

HOR = Horizontal ±15°

H45 = Horizontal to -45° only

VBU = Vertical Base Up ±15°

VBD = Vertical Base Down ±15°

If no special burn position is noted, the burn position is universal.

## P

## PAR Lamp

PAR is an acronym for a parabolic aluminized reflector. A PAR lamp, which may use either an incandescent filament, a halogen filament tube or HID arc tube is a precision pressed-glass reflector lamp. PAR lamps rely on both the internal reflector and prisms in the lens for the control of the light beam.

## Phosphor

An inorganic chemical compound processed into a powder and deposited on the inner glass surface of fluorescent tubes and some mercury and metal-halide lamp bulbs. Phosphors are designed to absorb short wavelength ultraviolet radiation and to transform and emit it as visible light.

# Glossary

## Power Factor (PF)

A measure of the phase difference between voltage and current on alternating current circuits. Power factors can range from 0 to 1.0 with 1.0 being ideal. Power factor is sometimes expressed as a percent. A high power factor means that an electrical system or device is utilizing power efficiently. Incandescent lamps always have power factors close to 1.0 because they are simple "resistive" loads. The power factor of a discharge lamp system is determined by the ballast used. "High" power factor usually means a rating of 0.9 or greater. The power factor of "core and coil" electromagnetic ballasts may be as low as 0.5-0.6.

## Precise™

The GE trade name for the compact MR-16 and MR-11 low-voltage halogen dichroic "cool beam" reflectorized spot and flood lamps.

## Product Code

It is important to use this five-digit code when ordering to ensure that you receive the exact product you require.

## Preheat Circuit

A type of fluorescent lamp-ballast circuit used with the first commercial fluorescent lamp products. A push button or automatic switch is used to preheat the lamp cathodes to a glow state. Starting the lamp can then be accomplished using simple "choke" or reactor ballasts.

## Q

## Quartzline

A GE registered trademark term for some types of tungsten-halogen lamps.

## R

## Rapid Start Circuit

A fluorescent lamp-ballast circuit which uses continuous cathode heating, while the system is energized, to start and maintain lamp light output at efficient levels. Rapid start ballasts may be either electromagnetic, electronic or of hybrid designs. Full-range fluorescent lamp dimming is only possible with rapid start systems.

## Reflector Lamp

An incandescent, compact fluorescent or HID lamp with a built in reflecting surface. Incandescent and HID versions are made from a single piece of blow-molded soft or

hard glass. CFL versions may be one piece or may be designed so that the inner lamp can be replaced.

## S

## SCC Code

The full 14 digit case code used on GE's content label.

## [Max] Seal Temperature

The maximum operating temperature of the seal of the lamp in Celsius.

## Series Resistance

In order to properly control the lamp current, a ballast resistor must be used. Lamps having screw bases have the necessary resistor built-in. Those having bayonet bases and those listed with wire terminals do not have a built-in resistor.

## Source Size

For Projection lamps, this is defined as the dimensions of the rectangular area, centered on the lamp axis, within which all luminous parts of the filament lie, when viewed perpendicular to the axis of the filament coil or to the plane of C-13 and C-13D filaments.

## Specification Series (SP) Colors

Energy-efficient, all-purpose tri-phosphor fluorescent lamp colors that provide good color rendering (as measured by the Color Rendering Index or CRI). The CRI for SP colors is 70 or above and varies by specific lamp type. Available chromaticities (or "tones") within the SP group include: SP30 (3000K) - a good match for the old standard "warm white" color and incandescent or halogen incandescent lamps. SP35 (3500K) - neutral all-purpose tone. SP41 (4100K) - cool in appearance and designed to match to old standard "cool white" color. SP50 - still cooler much like the combination of sun-sky-clouds. SP65 - A color with a very cool appearance, much like north skylight, and designed to match the appearance of the old "daylight" color. SP fluorescent colors are available in most of the widely used linear lamp types including the T8, T12, slimline, U-tube, high output and 1500 mA types.

## Specification Series Deluxe (SPX) Colors

Energy-efficient, tri-phosphor fluorescent lamp colors that provide better color rendering (as measured by the CRI) than Specification Series

colors. The CRI or SPX colors is 80 or higher and varies by specific lamp type. Available chromaticities within the SPX include: SPX27 (2700K) - A visually "warm" tone intended to match the visual appearance of low wattage incandescent lamps. SPX30 (3000K) - A good match with high wattage incandescent and halogen incandescent lamps. SPX35 (3500K) - A widely used, neutral all-purpose tone. SPX41 (4100K) - Cool in appearance. SPX 50 (5000K) - a daylight simulating color with a very cool appearance much like skylight. SPX fluorescent colors are available in most of the widely-used lamp types including T8, T12, and U-Tube and high lumen Biax® types. GE compact fluorescent lamps (CFL's) typically use only SPX colors.

## Spectral Power Distribution (SPD)

A graph of the radiant power emitted by a light source as a function of wavelength. SPD's provide a visual provide or "finger print" of the color characteristics of the source throughout the visible part of the spectrum.

## [Minimum] Starting Temperature

The minimum ambient temperature at which the lamp will start reliably.

## [Maximum] Starting Time

The time in seconds for the lamp to reach 90% of light output after being switched on.

## T

## TCLP Test

The Toxicity Characteristics Leaching Procedure (TCLP) test specified in the Resource Conservation and Recovery Act (RCRA) of 1990, is used to characterize fluorescent lamp waste as hazardous on non-hazardous waste. The TCLP test measures the ability of the mercury in a lamp to leach from a landfill into ground water under very aggressive and reactive conditions.

## [Minimum or Maximum] Terminal to Terminal Starting Lamp Voltage (Vrms)

The minimum or maximum allowed voltage allowed into lamp from ballast under varying conditions as specified.

## Total Harmonic Distortion (THD)

A measure (in percent) of power quality. THD indicates the distortion of the alternating current wave form. Low values (<20%) are preferred.



## U

### UCC

The 12 digit case code derived from the last 12 digits of the 14 digit SCC code on GE's case content label.

### Underwriters Laboratories (UL)

A private organization which tests and lists electrical (and other) equipment for electrical and fire safety according to recognized UL and other standards. A UL listing is not an indication of overall performance. Lamps are not UL listed except for compact fluorescent lamp assemblies - those with screw bases and built-in ballasts

### Ultraviolet (UV) Radiation

Radiant energy in the range of about 100-380 nanometers (nm). For practical applications, the UV band is broken down further as follows:

Ozone Producing: 180-220nm

Bactericidal (germicidal): 220-300 nm

Erythema (skin reddening): 280-320 nm

"Black" light: 320-400 nm

The International Commission on Illumination (CIE) defines the UV bands as UV-A (315-400nm); UV-B (280 - 315 nm) and UV-C (100-280). "%UV\_ Reduction" is the percentage of the particular band of UV light that is reduced.

### UPC

The 12 digit code on the saleable unit that is used for scanning at the register.

### [Design] Voltage

A measurement of the electromotive force in an electrical circuit or device expressed in volts. Voltage can be thought of as being analogous to the pressure in waterline. For Automotive lamps, voltage at which the lamp is designed to provide the amperes, candlepower, and laboratory life characteristics. For Projection lamps, the voltage shown is the design voltage of the lamp, on which the life and wattage ratings are based. Lamps for which 115-120 is shown in the Volts column are designed at 118 volts. Lamps are available only in the design voltage(s) shown. When ordering lamps listed for more than one voltage, be sure to specify the voltage required. (Supply voltage variation can significantly affect lamp life.)

## W

### [Max Bulb] Wall Temperature

The maximum operating bulb wall temperature in Celsius.

### Warm Up Time to 90%

The time it takes for a High Intensity Discharge lamp to reach 90% of light output after being turned on.

### Watt

A unit of electrical power. Lamps are rated in watts to indicate their power consumption. Power consumed over time equals the electrical energy used.

### Watt-Miser®

A Watt-Miser® lamp is a term used by GE to indicate a reduced-wattage lamp with performance characteristics (life, light output, etc.) such that it can usually directly replace a higher-wattage product. Watt-Miser® lamps are available in a wide range of incandescent and fluorescent lamp types.

### [Reduced] Wattage indicator

Indicates that this is a reduced wattage option for lamps normally used in this application. Be sure to check wattage, lumens and life to determine which lamp is best suited to your needs.

### Width of Lamp

Referenced by IEC as Dimension A.

### [Typical] Working Distance

For Multi-Mirror® and other reflector Quartzline® lamps and MARCTM Projection lamps, the Working Distance shown is the distance from the front surface of the reflector rim to the film plane, in the optical system for which the lamp was first designed. In most cases, it provides a uniform plane of light for the intended aperture.

### Energy efficiency classification

The European Union published a Commission Directive in January 1998 regarding the efficiency labelling of household lamps (98/11/EC) effective 1 July 1999. However a transition period is allowed for lamps displaying the label at retail outlets until 1 January 2001.

The directive requires that all household lamps that are supplied directly from the mains have a label on the product/packaging that indicates the energy efficiency class of lamp (lm/W). Lamps which have a luminous flux of greater than 6,500 lumens are excluded from the labelling requirement. Reflector lamps and those with an input power of less than 4 watts are also excluded.

The classification scheme grades lamps into 7 classes, from **A** to **G**, with class **A** having the highest efficiency.

The scheme classifies lamps as follows:

- A** Triphosphor fluorescent lamps, both linear and pin compact fluorescent. Integral compact fluorescent with electronic ballast
- B** Halophosphate linear fluorescent. Some pin compact fluorescent. Integral compact fluorescent with magnetic ballast
- C** High efficiency halogen lamps
- D** Other halogen lamps
- E/F** Standard incandescent lamps
- G** Decorative incandescent and others

Energy	
A	
B	
C	
D	
E	<b>E</b>
F	
G	
XYZ	Lumen
1000	Watt h

# Sales office addresses

## ALBANIA

VSD Merkur dool Sales  
Representative of GE Hungary ZRt.  
Bulv. Zogu I-re Pallati 103/6B  
Tirane  
Phone: (355) 4 226 4807

## ALGERIA, GHANA, LYBIA, MOROCCO, NIGERIA, TUNISIA

GE Hungary Zrt.  
1340 Budapest  
Váci út 77  
HUNGARY  
Tel: (36) 1 231 5280  
Fax: (36) 1 231 5121

## ANGOLA, BOTSWANA, KENYA , MADAGASCAR, MAURITIUS, MOZAMBIQUE, NAMIBIA, SOUTH AFRICA,

**TANSANIA, ZAMBIA, ZIMBABWE**  
GE South Africa - Consumer and  
Industrial  
Unit 4, 130 Gazelle Avenue,  
Corporate Park  
Midrand 1685  
SOUTH AFRICA  
Tel: (27) 11 237 0000  
Fax: (27) 11 314 7518

## ARGENTINA

GE Iluminacion S.A.  
Edificio Uruguay III  
Virasoro 2656, 2° PISO  
(B1643HDB) Beccar, Buenos Aires  
Phone: (54) 11 5556 3300  
Fax: (54) 11 4736 6616

## AUSTRALIA

GE Lighting Australia Ltd.  
125-127 Long Street  
Smithfield, NSW 2164  
Phone: (61) 2 9729 0011  
Fax: (61) 2 9729 1144

## AUSTRIA

GE Lighting GmbH  
Eisenstr. 5  
65428 Rüsselsheim  
Germany  
Phone: (49)-6142-601-163  
Fax: (49)-6142-601-164

## BAHRAIN, KUWAIT, OMAN, PAKISTAN, QATAR, SRI LANKA, UAE

GE International Inc.  
City Tower II, Sheikh Zayed Rd  
P.O.Box 52905  
Dubai  
U.A.E.  
Tel: (971) 4 3310 444  
Fax: (971) 4 3315 930

## BOSNIA AND HERZEGOVINA, CROATIA, SLOVENIA

Adria Lighting & Power Protection  
Media Light d.o.o.  
Exclusive agent of GE Hungary Rt.  
Lighting and Power Protection for  
Bosnia, Croatia and Slovenia.  
Tacenska 114A  
1000 Ljubljana  
Slovenia  
Phone: (386) 1 5304366  
Fax: (386) 1 530 4361

## BOTSWANA, NAMIBIA, SOUTH AFRICA, ZIMBABWE

GE Lighting South Africa  
Unit 4 Northside Corporate Park  
130 Gazelle Avenue  
SOUTH AFRICA  
Phone: (27) 11 238 3000  
Fax: (27) 11 314 7518

## BRAZIL, URUGUAY

General Electric do Brasil  
Parque Industrial  
Thomas Edison  
Rua Miguel Angelo, 37  
Maria da Graca  
Rio de Janeiro 20783-900, Brazil  
Phone: (55) 21 582 6471  
Fax: (55) 21 582 6533

## BULGARIA

GEII-Bulgaria  
Str.Dragan Tzankov 36, 1040 Sofia  
Phone: (359) 2 973 3148  
Fax: (359) 2 971 4384

## CANADA

GE Lighting Canada  
468 South Service Road E,  
Oakville, Ontario L6J 2X6  
Phone: (1) 877 259 0941

## CARIBBEAN & CENTRAL AMERICA

General Electric Company  
790 N.W. 107 Avenue, Suite 204  
Miami, Florida 33172, USA  
Phone: (1) 305 551 5114  
Fax: (1)305 551 5116

## CHILE / BOLIVIA

General Electric de Chile S/A  
Casilla 2103  
Av. Vicuna Mackenna 2385,  
Santiago  
Phone: (56) 2 555 3031  
Fax: (56) 2 556 7329

## CHINA

GE Consumer &  
Industrial Shanghai Office  
(GE Enterprise Development Co., Ltd)  
(GE Lighting Co., Ltd)  
22F~24F, Building C, Hi-Tech  
Building, 900 Yishan Road,  
PC: 200233  
Shanghai, P.R. China  
Phone: 86-21-24013333  
Fax: 86-21-64857177

## COLOMBIA

GE Lighting, Colombia  
Carrera 5 No. 81-50 Apto 204  
El Pinar, Alto, Santafe de Bogota

## CYPRUS, GREECE, MALTA

General Electric Medical Systems SA  
156 Kyprou Av. & 91  
Konstantinoupoleos Str.  
164 51 Argryroupolis, Athens  
Greece  
Phone: (30) 210 9690 669  
Fax: (30) 210 9625 931

## CZECH REPUBLIC

GE Lighting, s.r.o.  
Lidická 965 / 31, 602 00 Brno  
Phone: (420) 5 4132 1015,  
(420) 5 4132 1016  
Fax: (420) 5 4132 1017

## DENMARK

GE Lighting A/S  
Park Alle 295  
DK-2605 Brøndby  
Phone: (45) 8040 4945  
Fax: (45) 8040 4947

## EGYPT, IRAQ, JORDAN, LEBANON, SAUDI ARABIA, SYRIA, YEMEN

GE International Operations Co.  
54 Lebanon Street,  
Mohandessin, Giza  
EGYPT  
Tel: (20) 2 301 8060 or 8065  
Fax: (20) 2 303 1082

## ESTONIA, LATVIA, LITHUANIA

General Electric Co.  
Polska Sp. z o.o.  
ul. Jagiellonska 74  
03-301 Warsaw  
Poland  
Phone: (372) 505 4298  
Fax: (372) 5307 0590

## FINLAND

GE Lighting Oy  
Malmin kauppatie 18, 5 krs.  
FIN-00700 Helsinki  
Phone: (358) 9 8560 6780  
Fax: (358) 9 8560 6790

## FRANCE & BENELUX

GE Lighting SARL  
ZAC Paris Nord II  
13, rue de la Perdrix  
B.P. 50073  
95947 Roissy CDG Cedex  
Phone: (33) 1 48 63 68 00  
Fax: (33) 1 48 63 68 08

## GERMANY

GE Lighting GmbH  
Eisenstr. 5  
65428 Rüsselsheim  
Phone: (49)-6142-601-163  
Fax: (49)-6142-601-164

## HONG KONG

GE International Operations Co.Inc.  
8th Floor, The Lee Gardens  
33 Hysan Avenue  
Causeway Bay  
Hong Kong  
Phone: (852)2100 6900  
Fax: (852)2376 0013

## HUNGARY

GE Hungary ZRt.  
1340 Budapest  
Váci út 77.  
Phone: (36) 1 399 1100  
Fax: (36) 1 399 1672

## INDIA

GE India Industrial Pvt Ltd.  
42/1, Electronic City Phase 2  
Bangalore - 560100  
Karnataka, India  
Phone: (91)80 41113000  
Fax: (91)80 28528366

## INDONESIA

PT.GE Lighting Indonesia  
Gedung BRI II,27 th Floor  
Jl.Jenderal Sudirman Kav.  
44-46,Jakarta 10210  
Phone: (62)21 574 5240  
Fax: (62)21 574 5241

## IRELAND

GE Lighting Ltd.  
280 Holly Road  
Western Industrial Estate  
Naas Road  
Dublin 12  
Phone: (353) 1 456 5591  
Fax: (353) 1 450 4142

## ITALY

Via Brescia 31,  
36040 Torri di Quartesolo (VI)  
Vicenza  
Phone: +39 0444 26781  
Fax: +39 0444 267818

We hope that this Spectrum catalogue has helped you to identify the right lamps to meet your particular lighting needs. We have made every effort to make it easy to use, to include accurate, up-dated product data and to provide useful information about lamp technologies and lighting applications. We take pride in our reputation for quality customer service and if there is any further information you need, please don't hesitate to contact your nearest GE Lighting sales office.



# Sales office addresses

## ISRAEL

GE Hungary ZRt.  
1340 Budapest  
Váci út 77  
Phone: (36) 1 399 1100  
Fax: (36) 1 399 1672

## JAPAN

GE Consumer Products Japan, Ltd.  
12F Akasaka Park Bldg., 5-2-20  
Akasaka, Minatoku,  
Tokyo 107-6112 Japan  
Phone: (81) 3 5544 6700  
Fax: (81) 3 5544 6760

## KAZAKHSTAN

GE International Inc. Branch in  
Kazakhstan  
Prime Business Center  
Ul. Furmanova, 100G, Office 302  
480091, Almaty  
Kazakhstan  
Phone: (7) 3272 588 010  
Fax: (7) 3272 588 011

## KOREA

GE Consumer & Industrial  
Lighting, Korea  
3F GE Tower, 71-3 Chungdam-Dong,  
Kangnam-Gu, Seoul, Korea 135-  
100  
Phone: (82) 2-6201-4331  
Fax: (82) 2-6201-4343

## MACEDONIA

VSD MERKUR dooel Exclusive Agent  
of GE Hungary ZRt.  
Vasil Glavinov 7B/3  
1000 Skopje  
Macedonia  
Phone: (389) 2 3244790  
Fax: (389) 2 3244797

## MALAYSIA

General Electric International Inc.  
Level 6 & 7, 1 Sentral,  
Jalan Travers,  
Kuala Lumpur Sentral,  
50470 Kuala Lumpur  
T: +603-2273 9788  
F: +603-2273 3473

## MEXICO

GE Lighting Mexico, SA de CV  
Av. Churubusco No 3900 Norte  
Apartado Postal 216  
64510 Monterrey, N.L. Mexico  
Phone: (52) 8 318 5600  
Fax: (52) 8 318 5693

## MONTENEGRO

VSD Merkur dooel Sales  
Representative of GE Hungary ZRt.  
Bul. Mihajla Pupina 10D/105  
11070 Novi Beograd  
Phone: (381) 11 311 9256  
Fax: (389) 2 324 4797

## NEW ZEALAND

GE Lighting New Zealand  
8 Tangihua St  
Auckland 1010  
New Zealand  
Phone +64 9 353 6706  
Fax +64 9 353 6707

## NORWAY

GE Lighting AS  
Karenslyst Allé 2, 0214 Oslo  
Phone: (47) 80011321  
Fax: (47) 80011048

## PERU/ECUADOR

GE Lighting Peru  
Av. Garcilaso de la Vega 1420  
Esquina Con Av. Espana, Lima  
Phone: (511) 433 9862  
Fax: (511) 332 0482

## PHILIPPINES

GE Lighting Philippines  
1873 P. Domingo Street  
1207 Makati City, Metro Manila  
POB 2087 MCC  
Phone: (63) 2 895 7051  
Fax: (63) 2 890 8186

## POLAND

Ul. Jagiellonska 74  
03-301 Warsaw  
VAT no.NIP 526-10-30-824  
Registration: REGON 011165913 KRS  
0000073794, Sad Rejonowy dla m. st.  
Warszawy, XIII Wydzial  
Gospodarczy  
Krajowego Rejestru Sadowego  
Initial capital: 9.365.500,00PLN  
Tel: (48 ) 22 519 42 15  
Fax: (48) 22 519 42 01

## PORTUGAL

GE Lighting Appliances España, s.a.  
Llull 95 - 97 Planta Baja  
08005 Barcelona, Spain  
Freephone in Portugal: 800.836.010  
Free fax in Portugal: 800.836.007

## ROMANIA, MOLDAVIA

TEMCO LIGHTING SRL  
Str. Iancu de Hunedoara 12C, apt. 3,  
BLOC "VILAFLO"R  
729947-Pipera - Voluntari  
Judetul ILFOV  
Telephone : 0040 316 201 029  
Fax : 0040 316 201 028

## RUSSIA

OOO GE Rus, Krasnopresnenskaya  
Nab., 18, Moscow, 123317, Russia  
Phone: (7) 495 739 6855  
Fax: (7) 495 739 6810

## SERBIA

VSD MERKUR dooel Exclusive Agent  
of GE Hungary ZRt.  
Bul. Mihajla Pupina 10D/105  
11070 Novi Beograd  
Phone: (381) 11 3119256  
Fax: (381) 11 3119257

## SINGAPORE, BRUNEI

GE Pacific Pte. Ltd.  
240, Tanjong Pagar Rd.  
GE Tower #06-00  
Singapore 088540, Singapore  
Phone: (65) 6326 3393  
Fax: (65) 6326 3015

## SLOVAKIA

GE Hungary ZRt  
1340 Budapest  
Váci út 77  
Phone: (36) 1 447 6461  
Fax: (36) 1 399 1672

## SPAIN

GE Lighting Appliances España, s.a.,  
Llull 95 - 97 Planta Baja,  
08005 Barcelona  
Freephone in Spain: 900 993.612  
Free fax in Spain: 900 993.609

## SWEDEN

GE Lighting AB  
Box 306, Solna strandväg 98  
171 75 Stockholm  
Phone: (46) 8 51 99 22 12  
Fax: (46) 8 51 99 22 14

## SWITZERLAND

GE Lighting GmbH  
Eisenstr. 5,  
65428 Rüsselsheim  
Germany  
Phone: (49)-6142-601-163  
Fax: (49)-6142-601-164

## THAILAND, CAMBODIA, LAOS

GE Lighting (Thailand)Ltd.  
1126/2 Vanit Building II, 16th Floor,  
Room No. 1603, New Petchburi  
Road, Makkasan, Rajchthewi,  
Bangkok 10400 Thailand  
Phone: 66 2 255 8721-31  
Fax: 66 2 255 8733

## TAIWAN

GE Lighting Taiwan  
7FL, No 8, Sec 3, Min Sheng E. Rd,  
Taipei, 104, Taiwan  
Tel: (886) 2 21837000  
Fax: (886) 2 25167356

## TURKEY

Sun Plaza, Dereboyu Sokak No.  
24/6, Maslak, Istanbul 34398 Turkey  
Phone:(90) 212 366 28 00 Fax: (90)  
212 366 28 40

## UKRAINE

General Electric Co.  
Horizont Tower  
42/44 Shovkovichna str., 8 Floor  
Kiev 01004  
Phone: (380) 44 490 69 83  
Fax: (380) 44 490 69 82

## UNITED KINGDOM

GE Lighting Ltd.  
Camp Road  
St Albans, AL1 5HL  
Phone: (44) 208 366 1166  
Fax: (44) 208 727 4400

## UNITED STATES OF AMERICA

GE Lighting  
Nela Park, 1975 Noble Road  
Cleveland, Ohio 44112  
Phone: (1) 216 266 2121  
Fax: (1) 216 266 2780

## VENEZUELA

GE Iluminacion de Venezuela  
S.A. TERMAQ  
Centro Banaven (Cubo Negro)  
Torre A Piso 6, Avenida La Estancia,  
Chuaq, Caracas, Venezuela  
Phone: (58) 212 902 5131  
Fax: (58) 212 902 5158

## VIETNAM

GE Consumer & Industrial  
7fl, Saigon Centre, 65 Le Loi blv, Dist.1,  
Hochiminh City, Vietnam  
Phone: (84)4 8251016  
Fax: (84)4 8250551